



56 Spring-Loaded Plunger

Flare-in style – Miniature, Small and Large

- Simplified positioning of sliding components
- Quick-release hinge for removable door
- Fast installation and removal of components
- Designate access with color

Material and Finish

End cap: Steel, zinc plated, chromate, plus sealer
 Ferrule: Aluminum, natural
 Stud: Steel, hardened, zinc plated, chromate, plus sealer
 Knob: (Prism plungers only)
 PC/ABS, UL94-V0 Rated
 Spring: 300 series stainless steel, passivated

Installation Notes

Press with approximately 2,500 N (562 lbf) (Large and Small), 2,000 N (450 lbf) (Mini) until ferrule is flared into the countersink in the panel.
 A solid back-up tool must be used for proper installation

Install Tool

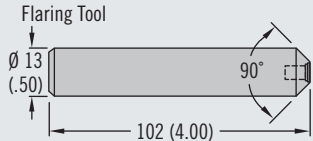

Applications

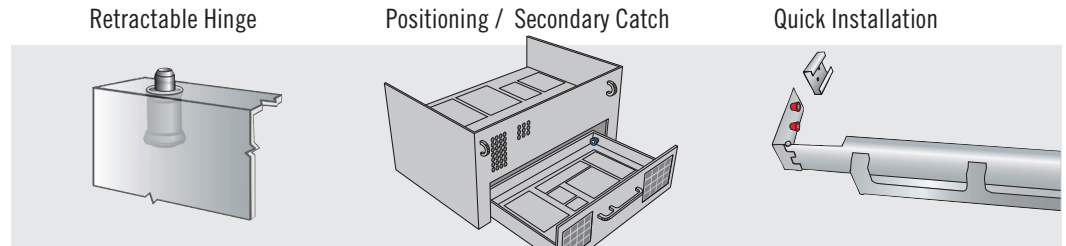

Flare-in style

Bright - Miniature and Small

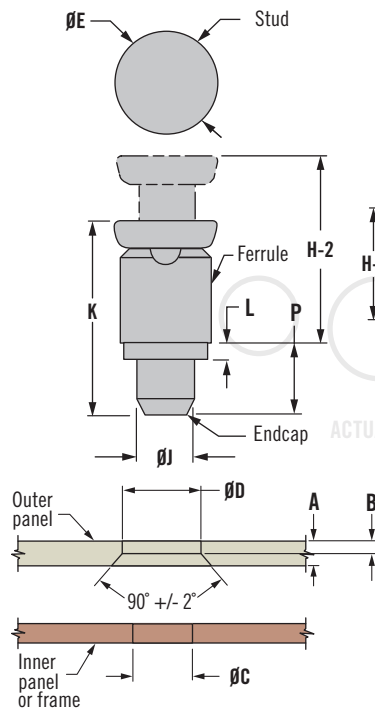

Prism - Miniature and Small

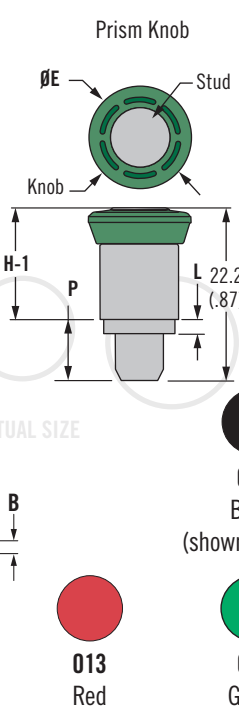

Prism - Large

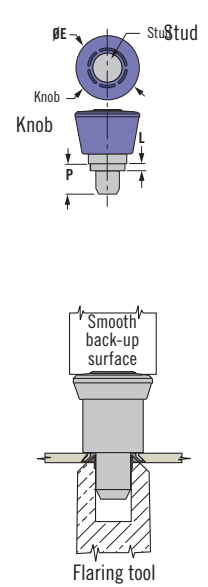

Part number:
 47-110 (Miniature)
 56-7-TOOL (Large and Small)

Part Number

See table

Specifying Prism Color

To indicate color, change the last three digits of the part number.
 Example:
 56-161-000, black
 56-161-013, red

Outer Panel Thickness		P	Size	Knob Style	Part Number		H-1	H-2	ø E	K	L	B	ø J	ø D	ø C
A Min.	A Max.				Hold-Open	Without									
0.8 (.031)	1.5 (.06)	4.4 (.17)	Mini	Bright	56-21-1-15	56-20-1-15	9.9 (.39)	13.6 (.54)	8.5 (.33)	14.3 (.56)	1.0 (.04)	0.41 (.016)	4.29 (.169) MAX	6.76 ^{+0.1} _{0.0}	4.3 ^{+0.13} _{0.0}
				Prism	56-121-1-000	56-120-1-000	10.6 (.42)	14.3 (.56)	9 (.35)	15 (.59)					
				4C-Prism	56-321-1-000	56-320-1-000	10.6 (.42)	14.3 (.56)	9 (.35)	15 (.59)					
				Bright	56-21-2-15	56-20-2-15	9.1 (.36)	12.8 (.50)	8.5 (.33)	14.3 (.56)					
1.5 (.06)	2.3 (.09)	5.2 (.20)	Mini	Prism	56-121-2-000	56-120-2-000	9.8 (.39)	13.5 (.53)	9 (.35)	15 (.59)	1.78 (.07)	0.41 (.016)	6.33 (.249)	9.19 ^{+0.08} _{0.0}	6.4 ^{+0.1} _{0.0}
				4C-Prism	56-321-2-000	56-320-2-000	9.8 (.39)	13.5 (.53)	9 (.35)	15 (.59)					
				Bright	56-71-1-15	56-70-1-15	13.7 (.54)	19.8 (.78)	11.5 (.45)	21.5 (.85)					
				Prism	56-171-1-000	56-170-1-000	14.5 (.57)	20.5 (.81)	13.3 (.52)	22.2 (.87)					
1.52 (.06)	3.17 (.125)	7.9 (.31)	Small	4C-Prism	56-371-1-000	56-370-1-000	14.5 (.57)	20.5 (.81)	13.3 (.52)	22.2 (.87)	1.78 (.07)	0.41 (.016)	6.33 (.249)	9.19 ^{+0.08} _{0.0}	6.4 ^{+0.1} _{0.0}
				Prism	56-171-2-000	56-170-2-000	12.9 (.51)	19 (.75)	13.3 (.52)	22.2 (.87)					
				Bright	56-71-2-15	56-70-2-15	12.2 (.48)	18.2 (.72)	11.5 (.45)	21.5 (.85)					
				4C-Prism	56-371-2-000	56-370-2-000	12.9 (.51)	19 (.75)	13.3 (.52)	22.2 (.87)					
3.17 (.125)	4.7 (.185)	9.4 (.37)	Large	Prism	56-271-1-000	56-270-1-000	14.5 (.57)	20.5 (.81)	17 (.67)	22.2 (.87)	3.3 (.13)	1.52 (.06)	6.33 (.249)	9.19 ^{+0.08} _{0.0}	6.4 ^{+0.1} _{0.0}
				4C-Prism	56-371-2-000	56-370-2-000	12.9 (.51)	19 (.75)	13.3 (.52)	22.2 (.87)					
				Bright	56-71-2-15	56-70-2-15	12.2 (.48)	18.2 (.72)	11.5 (.45)	21.5 (.85)					
				Prism	56-271-2-000	56-270-2-000	12.9 (.51)	19 (.75)	17 (.67)	22.2 (.87)					



56 Spring-Loaded Plunger

Press-in style – Miniature, Small and Large



Press-In Style

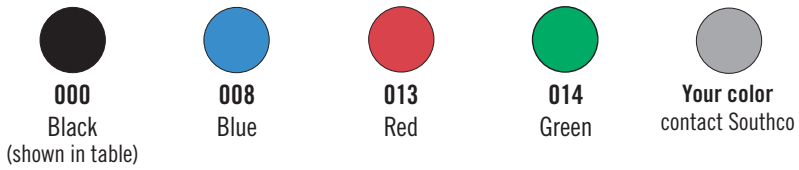
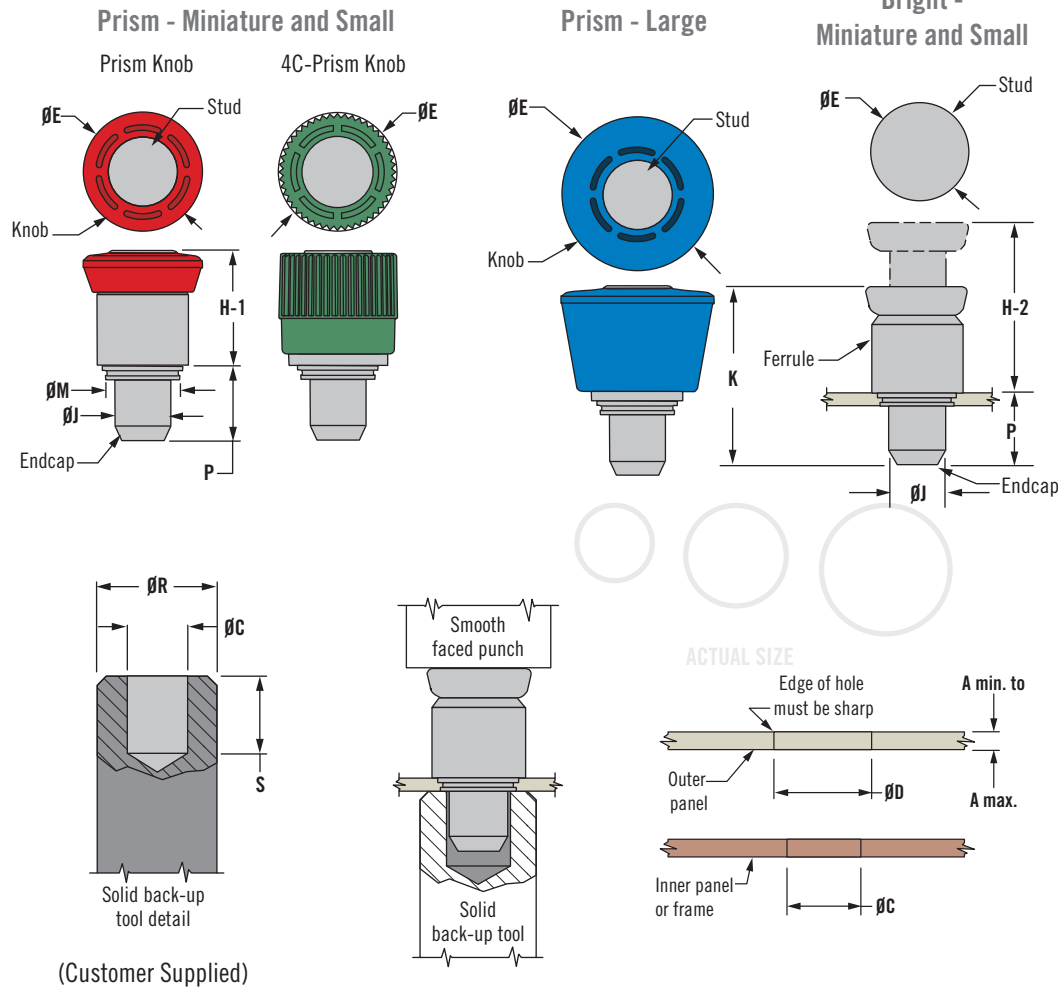

- Simplified positioning of sliding components
- Quick-release hinge for removable door
- Fast installation and removal of components
- Designate access with color

Material and Finish

End cap: Steel, zinc plated, chromate, plus sealer

Ferrule and stud: Steel, (Large and Small hardened), zinc plated, chromate plus sealer

Knob: (Prism plungers only) PC/ABS, black, UL94-V0 Rated

Spring: 300 series stainless steel, passivated

Installation Notes

Press knob with approximately 13,400 N (3000 lbf) (Large and Small), 8000 N (1800 lbf) (Mini) for steel, 6700 N (1500 lbf) (Large and Small), 5000 N (1124 lbf) (Mini) for aluminum panels until ferrule sits flush with panel. A solid back-up tool must be used for proper installation.

Part Number

See table

Specifying Prism Color

To indicate color, change the last three digits of the part number.

Example:
56-161-000, black; 56-161-013, red

Outer Panel Thickness		P	Size	Knob Style	Part Number		H-1	H-2	E	K	J	M	D	C	R	S
A Min.	A Max.				Hold-Open	Without										
0.8 (.031)	1.5 (.06)	4.4 (.17)	Mini	Bright	56-11-15	56-10-15	9.2 (.36)	12.9 (.51)	8.5 (.33)	13.6 (.54)	4.29 (.169) MAX	6.6 (.26)	6.7 ^{+0.08} _{0.0} (.264 ^{+0.003} _{0.000})	4.3 ^{+0.13} _{0.0} (.169 ^{+0.005} _{0.000})	9 (.35) MIN	4.5 (.18) MIN
				Prism	56-111-000	56-110-000	9.9 (.39)	13.6 (.54)	9 (.35)	14.3 (.56)						
				4C-Prism	56-311-000	56-310-000	9.9 (.39)	13.6 (.54)	9 (.35)	14.3 (.56)						
1.52 (.06)	3.81 (.15)	8.2 (.32)	Small	Bright	56-61-15	56-60-15	12.2 (.48)	19.3 (.76)	11.5 (.45)	20.4 (.80)	6.33 (.249)	8.26 (.325)	8.4 ^{+0.0} _{0.1} (.328 ^{+0.003} _{0.000})	6.4 ^{+0.1} _{0.0} (.250 ^{+0.005} _{0.000})	13 (.50) MIN	8.26 (.325) MIN
				Prism	56-161-000	56-160-000	13 (.51)	20 (.79)	13.3 (.52)	21.1 (.83)						
				4C-Prism	56-361-000	56-360-000	13 (.51)	20 (.79)	13.3 (.52)	21.1 (.83)						
			Large	Prism	56-261-000	56-260-000	13 (.51)	20 (.79)	17 (.67)	21.1 (.83)						



56 Spring-Loaded Plunger

Thread-in style · Small and Large

- Simplified positioning of sliding components
- Quick-release hinge for removable door
- Fast installation and removal of components

Material and Finish

Knob: Aluminum

Stud: Low carbon steel, case hardened, zinc plated, chromate plus sealer

Shell and sleeve: Steel, zinc plated, chromate plus sealer

Spring: Stainless steel, passivated

Detent washer: Steel, zinc plated (Hold-open only)

Part Number

See table

Part Number

See table

300 Series Bright - Small

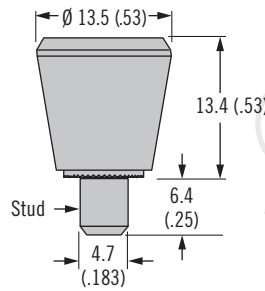

400 Series Bright - Large

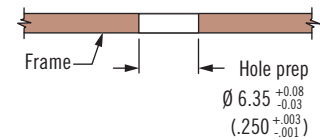
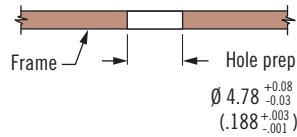
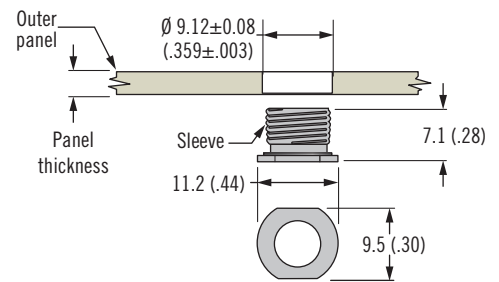
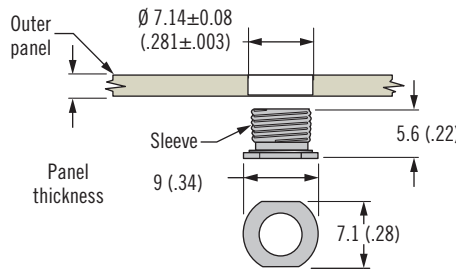
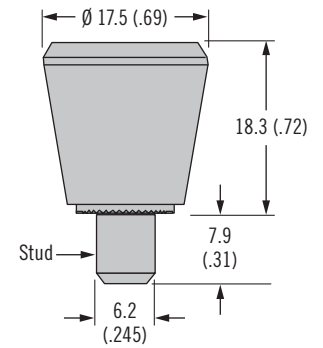

Series	Panel Thickness		Part Number	
	Minimum	Maximum	With Hold Open Feature	Without Hold Open Feature
300	0.64 (.025)	1.52 (.060)	56-10-301-20	56-99-196-20
400	0.79 (.031)	3.18 (.125)	56-10-401-20	56-99-197-20

Installation tool

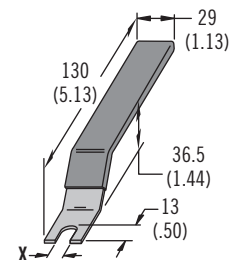
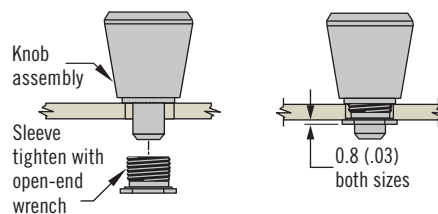

Series	X (Tool)	Tool Part Number
300	7.1 (.28)	56-0-22041-03
400	9.5 (.38)	56-0-22041-04

Other options available. For complete details on variety, part numbers, installation and specification, go to



www.southco.com/56

Dimensions in millimeters (inch) unless otherwise stated

Installation Guidelines

for *SOUTHCO*[®] Self-Clinching products

Self-clinching product installation is offered on these *SOUTHCO*[®] products, making them easy-to-use captive panel fasteners:

- Captive Screws
- Receptacles for Quarter-turn Fasteners
- Receptacles for Fast-lead Thread Screws

When pressed into a properly prepared hole, self-clinching captive fasteners cold-flow (move) the panel material into the retaining groove of the fastener. This material then retains the fastener in the panel.

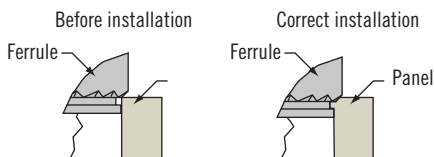

Successful press-in installations depend on:

Material:

The hardness of the panel material must not exceed *SOUTHCO*[®] recommendations. If the panel is too hard, the fastener will not install correctly.

Installation Holes:

Mounting holes may be drilled, punched, or cast.

- Hole edge: the top hole edge must be sharp but with no broken edges.

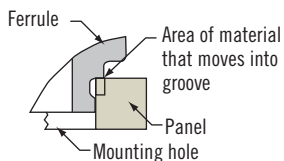

Do not chamfer or debur edge.

- Punched holes: use a punch and die with a small clearance to minimize the rollover and fracture angle.
- Hole diameter: measure the hole diameter at the panel surface on the side on which the fastener will be installed. The diameter must be within *SOUTHCO*[®] specifications for that product.

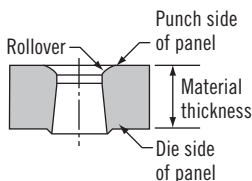

- If the hole is too large, not enough material will flow into the

retaining groove and the fastener may not be retained adequately.

- If the hole is too small, the fastener will not fit and installation may become difficult and unsafe.
- Hole distance from the edge of panel: the minimum recommended distance is 1.5 x the diameter of the mounting hole, unless otherwise indicated.

- Spring-loaded Plungers
- Captive Nuts
- Threaded Inserts

- Installing too close to the edge will cause the material to flow in the opposite direction, deforming the edge of the panel. To install closer to the edge, you may need to restrain the panel edge.

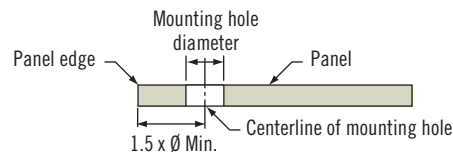

Panel Thickness:

The thickness of the panel at the mounting hole location must meet or exceed Southco's stated minimum recommendations.

If the material is too thin, panel deformation and/or damage to the fastener may result.

Installation is fast and easy if you follow these tips:

How to install: Use the recommended force where noted and a proper back-up tool.

- use any parallel-acting press
- use a punch whose diameter is larger than the head of the fastener

Installation Force: Proper installation requires an even distribution of adequate force. It does not depend on the distance the fastener is pressed into the panel.

- Southco does not recommend using a hammer. The impact force does not provide an even distribution of force to allow the panel material to completely flow into the fastener's retaining groove.
- Installation force varies from application to application, depending on the criteria noted above.
- On parts without a collar to provide a hard stop, press-in until the edge of the knurl is just barely visible.

When to Install:

Installation is recommended after plating or finishing has been applied to the panel.

The hole diameter must meet specifications before finish or plating is applied.

- Do not over-install parts. This interrupts the material and will reduce the retention strength.

