

Vacuum block

<https://www.schmalz.com/10.01.12.01300>



VCBL-S1 130x30x32.7
D-360 TV

Part no.: 10.01.12.01300

Homepage > Vacuum Clamping Technology > Clamping Solutions for Woodworking > Console Table Systems > Clamping Equipment for SCM / Morbidelli Consoles > VCBL-S1 130x30x32.7 D-360 TV

Vacuum block for SCM/Morbidelli console - Type 1



Dimensions (LxB): 130 x 30 mm
Height H: 32.7 mm
Arrangement: Can be turned 360°
with: Sensing valve

Design Data

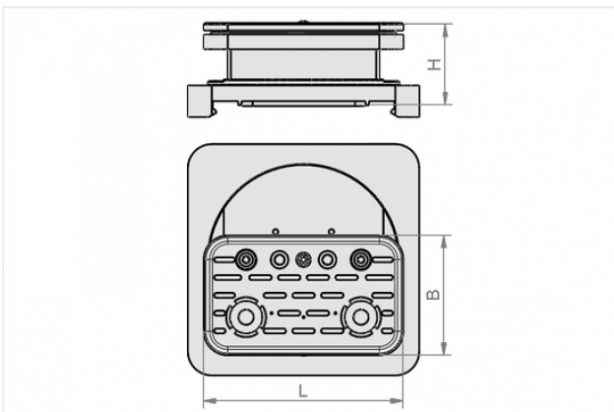

Attribute	Value
-----------	-------

B	30 mm
---	-------

H	32.7 mm
---	---------

L	130 mm
---	--------

Technical Data

Attribute	Value
-----------	-------

Weight	0.431 kg
--------	----------

SCM / Morbidelli is a registered and protected trademark. The articles listed here are products of J. Schmalz GmbH that have been designed to fit CNC machining centers from SCM / Morbidelli.

Contact to Schmalz

J. Schmalz GmbH | Johannes-Schmalz-Straße, 72293 Glatten, Deutschland | +49 7443 2403-102 | customercenter@schmalz.de



[Contact to Schmalz](#)

J. Schmalz GmbH | Johannes-Schmalz-Straße, 72293 Glatten, Deutschland | +49 7443 2403-102 |
customercenter@schmalz.de