

Vacuum block

VCBL-S4 125x75x50 TV

<https://www.schmalz.com/10.01.12.02322>



Part no.: 10.01.12.02322

Homepage > Vacuum Clamping Technology > Clamping Solutions for Woodworking > Console Table Systems > Clamping Equipment for SCM / Morbidelli Consoles > VCBL-S4 125x75x50 TV

Vacuum block for SCM/Morbidelli console - Type 4



Dimensions (LxB): 125 x 75 mm
Height H: 50 mm
with: Sensing valve

Design Data

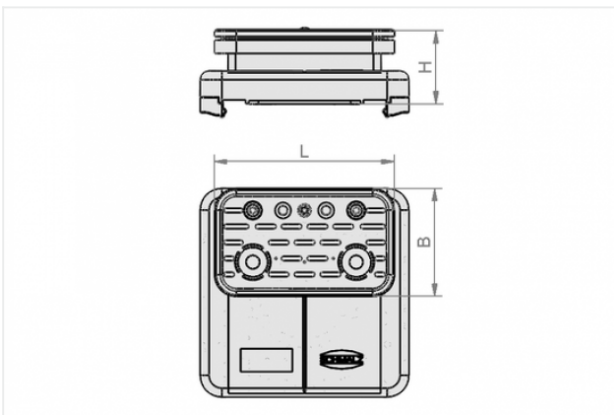

Attribute	Value
-----------	-------

B	75 mm
---	-------

H	50 mm
---	-------

L	125 mm
---	--------

Technical Data

Attribute	Value
-----------	-------

Weight	0.641 kg
--------	----------

SCM / Morbidelli is a registered and protected trademark. The articles listed here are products of J. Schmalz GmbH that have been designed to fit CNC machining centers from SCM / Morbidelli.

Contact to Schmalz

J. Schmalz GmbH | Johannes-Schmalz-Straße, 72293 Glatten, Deutschland | +49 7443 2403-102 | customercenter@schmalz.de



[Contact to Schmalz](#)

J. Schmalz GmbH | Johannes-Schmalz-Straße, 72293 Glatten, Deutschland | +49 7443 2403-102 |
customercenter@schmalz.de