

# Vacuum block

## VCBL-K2 130x30x125 L

<https://www.schmalz.com/10.01.12.02126>



Part no.: 10.01.12.02126

Homepage > Vacuum Clamping Technology > Clamping Solutions for Woodworking > Console Table Systems > Clamping Equipment for Schmalz  
Consoles (two-circuit) > VCBL-K2 130x30x125 L

### Vacuum block for Schmalz 2-circuit console



Dimensions (LxB): 130 x 30 mm

Height H: 125 mm

Arrangement: longways

### Design Data

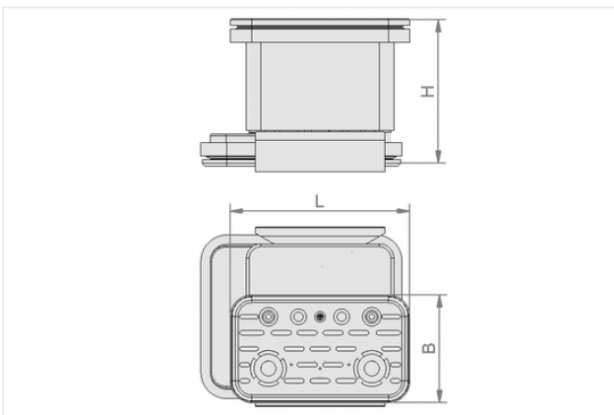

#### Attribute

#### Value

H

125 mm

### Technical Data

#### Attribute

#### Value

Weight

0.718 kg

### Contact to Schmalz

J. Schmalz GmbH | Johannes-Schmalz-Straße, 72293 Glatten, Deutschland | +49 7443 2403-102 | [customercenter@schmalz.de](mailto:customercenter@schmalz.de)

