

Vacuum block

VCBL-K2 120x50x125 Q

Part no.: 10.01.12.02119

<https://www.schmalz.com/10.01.12.02119>



Homepage > Vacuum Clamping Technology > Clamping Solutions for Woodworking > Console Table Systems > Clamping Equipment for Schmalz
Consoles (two-circuit) > VCBL-K2 120x50x125 Q

Vacuum block for Schmalz 2-circuit console



Dimensions (LxB): 120 x 50 mm

Height H: 125 mm

Arrangement: crossways

Design Data

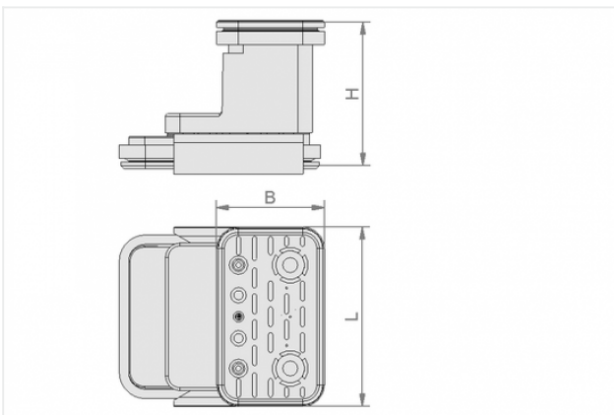

Attribute	Value
-----------	-------

B	50 mm
---	-------

H	125 mm
---	--------

L	120 mm
---	--------

Technical Data

Attribute	Value
-----------	-------

Weight	0.748 kg
--------	----------

Contact to Schmalz

J. Schmalz GmbH | Johannes-Schmalz-Straße, 72293 Glatten, Deutschland | +49 7443 2403-102 |
customercenter@schmalz.de

