

Vacuum block

VCBL-K2 130x30x75 L

<https://www.schmalz.com/10.01.12.02208>



Part no.: 10.01.12.02208

Homepage > Vacuum Clamping Technology > Clamping Solutions for Woodworking > Console Table Systems > Clamping Equipment for Schmalz
Consoles (two-circuit) > VCBL-K2 130x30x75 L

Vacuum block for Schmalz 2-circuit console



Dimensions (LxB): 130 x 30 mm

Height H: 75 mm

Arrangement: longways

Design Data

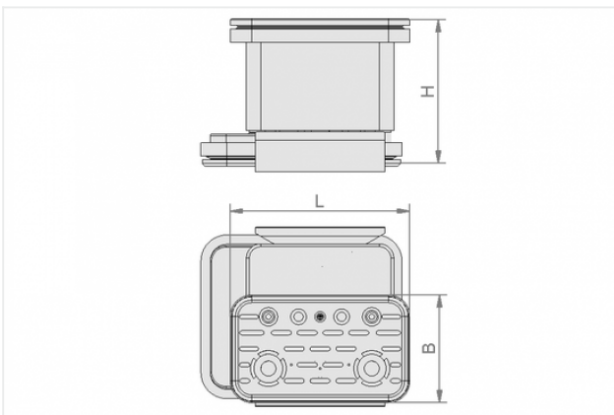

Attribute	Value
-----------	-------

H	75 mm
---	-------

Technical Data

Attribute	Value
-----------	-------

Weight	0.556 kg
--------	----------

Contact to Schmalz

J. Schmalz GmbH | Johannes-Schmalz-Straße, 72293 Glatten, Deutschland | +49 7443 2403-102 | customercenter@schmalz.de



Contact to Schmalz

J. Schmalz GmbH | Johannes-Schmalz-Straße, 72293 Glatten, Deutschland | +49 7443 2403-102 |
customercenter@schmalz.de