

Vacuum sensor

VS-V-SA STR4

<https://www.schmalz.com/10.06.02.00226>



Part no.: 10.06.02.00226

Homepage > Vacuum Technology for Automation > Vacuum Components > Switches and System Monitoring > Vacuum and Pressure Sensors >

Vacuum Sensor VS-V-SA > VS-V-SA STR4

Miniature vacuum sensor with analogue output signal



Connection: Tube $\varnothing 4$
Measuring range: -1.00 ... 0.00 bar
Cable length: 3 m

Design Data

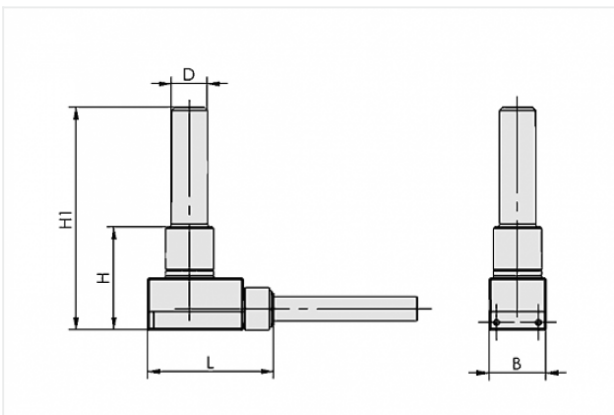

Attribute	Value
-----------	-------

B	9.5 mm
H	17.2 mm
L	21 mm
Lk	3 m

Technical Data

Attribute	Value
Measured medium	Non-aggressive gases; dry, oil-free air
Overpressure resistance	5 bar

Contact to Schmalz

J. Schmalz GmbH | Johannes-Schmalz-Straße, 72293 Glatten, Deutschland | +49 7443 2403-102 | customercenter@schmalz.de

Attribute	Value
Repeatability	± 1% of full-scale value
Inputs/outputs	Analogue: 1...5 V
Electrical connection	Cable
Connection	Tube Ø4
Voltage	10-24V DC
Protection	IP 40
Temperature influence	± 3% of full-scale value
Weight	5 g
