

## Operating Instructions Vacuum Generator VZ

**Note**

These operating instructions were written in the German language.  
This document should be kept in a safe place for future reference.

The right to make technical changes is reserved. No responsibility is taken for printing errors or other types of errors.

**Publisher**

© J. Schmalz GmbH, 12.2017

This document is protected by copyright. J. Schmalz GmbH retains the rights established thereby. Reproduction of the contents, in full or in part, is only permitted within the limits of the legal provisions of copyright law. Any modifications to or abridgments of the document are prohibited without explicit written agreement from J. Schmalz GmbH.

**Contact**

J. Schmalz GmbH  
Johannes-Schmalz-Str. 1  
D-72293 Glatten

T: +49 7443 2403-0  
schmalz@schmalz.de  
www.schmalz.com

Contact information for the Schmalz companies and trading partners, see  
 [www.schmalz.com/vertriebsnetz](http://www.schmalz.com/vertriebsnetz)

# Contents



## Operating Instructions Vacuum Generator VZ

1	Safety Notes.....	4
1.1	Classification of Safety notes .....	4
1.2	Warnings .....	5
1.3	Signs.....	5
1.4	General safety instructions.....	6
1.5	Intended use.....	6
1.6	Requirement for the user.....	7
1.7	Emissions .....	7
1.8	Definition of the Danger Zone .....	7
2	Product description .....	8
2.1	Technical Data of Vacuum Generators VZ .....	8
2.2	Dimensions.....	9
2.3	Components of the Vacuum Generator .....	10
2.4	Vacuum pump .....	11
2.5	Accessories Motor Overload Switch / Vacuum Controlled Motor Operation.....	11
3	Transport and Installation.....	11
3.1	Transport .....	11
3.2	Installation site.....	11
3.3	Installation Procedure.....	12
3.3.1	Checking the Oil Level .....	12
3.3.2	Checking the Rotation Direction of the Pump .....	13
3.3.3	Safety feature .....	13
4	Operation .....	14
4.1	Switching On / Off .....	14
5	Maintenance.....	15
5.1	Vacuum Pump.....	15
5.2	Filter.....	15
5.3	Adjusting the Vacuum Controlled Motor Operation.....	15
5.4	Trouble Shooting, Remedy.....	16
6	Guarantee, spare- and consumable parts.....	16
6.1	Spare- and consumable parts .....	17
6.2	Nameplate .....	17
6.3	Decommissioning .....	18
7	Applicable documents .....	18
8	Conformity Declaration.....	19

# 1 Safety Notes

## 1.1 Classification of Safety notes

### Danger

This warning informs the user of a risk that will result in death or serious injury if it is not avoided.

 <b>DANGER</b>	
	<b>Type and source of the Danger</b> Consequence ► Remedial action

### Warning

This warning informs the user of a risk that could result in death or serious injury if it is not avoided.

 <b>WARNING</b>	
	<b>Type and source of the Danger</b> Consequence ► Remedial action

### Caution

This warning informs the user of a risk that could result injury if it is not avoided.

 <b>CAUTION</b>	
	<b>Type and source of the Danger</b> Consequence ► Remedial action

### Important

This warning informs the user of a risk that could result damage to property if it is not avoided.

<b>IMPORTANT</b>	
	<b>Type and source of the Danger</b> Consequence ► Remedial action



### Notice

This symbol is used when important notes and information regarding use of the machine/the system/the device are provided.

	Information on the use
---	------------------------





## 1.2 Warnings

Explanation of the warning symbols used in the operating instructions.

Warning symbols	Description	Warning symbols	Description
	General warning symbols		Warning of environmental damage
	Warning of explosive atmosphere		



## 1.3 Signs

Explanation of the mandatory symbols used in the operating instructions.

Signs	Description	Signs	Description
	Adhere to the operating instructions		Use eye protection
	Use ear protectors		Activate prior to maintenance or repair
	Wear head protection		

## 1.4 General safety instructions

The central vacuum units are state-of-the-art and operationally reliable. However, there are still risks if the following safety instructions are not observed.



 <b>WARNING</b>	
	<p><b>Ignoring the general safety guidelines</b> Personal injuries / damage to plants / systems</p> <ul style="list-style-type: none"> <li>▶ The operating instructions contain important information on using the central vacuum unit. Read the operating instructions thoroughly and keep them for later reference.</li> <li>▶ The system may only be connected and operations started once the operating instructions have been read and understood.</li> <li>▶ Use only the connections, mounting holes and attachment materials that have been provided.</li> <li>▶ Carry out mounting or removal only when the device is in an idle, depressurized state.</li> <li>▶ Only qualified specialist personnel, mechanics and electricians may perform the installation. Qualified specialist personnel are persons who have received technical training and have the knowledge and experience – including knowledge of corresponding regulations – necessary to enable him or her to recognize possible dangers and implement the appropriate safety measures while performing tasks. The same applies to maintenance!</li> <li>▶ General safety regulations, European standards and VDE guidelines must be observed and complied with.</li> <li>▶ No person may sit or stand in the danger zone while the machine or plant is in automatic mode.</li> <li>▶ It is not permitted to make changes to system components.</li> <li>▶ Protect the components from damage of any kind.</li> </ul>

## 1.5 Intended use

The vacuum generator VZ is designed to generate and keep available a defined vacuum.

Installations connected to the vacuum generator must comprise safety measures preventing that people, animals or property are endangered by a possible break down of the vacuum pressure.

Operation, maintenance and service conditions prescribed in this manual must be observed.

 <b>DANGER</b>	
	<p><b>Modifications or changes to the central vacuum unit without approval</b> Danger to life and limb</p> <ul style="list-style-type: none"> <li>▶ For safety reasons, modifications or changes without approval are forbidden</li> </ul>

## 1.6 Requirement for the user

All personnel working with the product must be familiar with basic mechanical and pneumatic principles as well as the appropriate technical terminology.

To ensure safe operation, this work may only be performed by qualified personnel or trained persons working under the supervision of qualified personnel.

*"A qualified employee is defined as an employee who has received technical training and has the knowledge and experience – including knowledge of corresponding regulations – necessary to enable him or her to recognize possible dangers and implement the appropriate safety measures while performing tasks. Qualified personnel must observe the pertinent industry-specific rules and regulations".*

## 1.7 Emissions

The continuous sound pressure output by the unit is less than 75 db(A).

It is thus below the level of 85 dB(A) determined by the EU Directive 2003/10/EG.



We still advise you to use ear protection during longer periods close to the central vacuum unit.v

## 1.8 Definition of the Danger Zone

The danger zone is the area inside, or in the vicinity of working equipment which poses a hazard or potential hazard to the health of persons located within this area.

The central vacuum unit supplies one or several vacuum suction cups. This means that it is possible that the load could fall during lifting or transport.

The area below the gripper and the load is always considered a danger zone.

A person may not sit or stand under the load for any reason. This applies without exception to both persons and individual body parts (head, hands, arms, legs, etc.).

No person may sit or stand in the designated danger zone.

The working area is to be secured (protective fence or sensors) by the user/operator in such a way that no person can enter the danger zone.

The central vacuum unit creates a strong suction that can draw in hair, clothing and the eyes.

## 2 Product description

The central vacuum units are operated via different pumps (dry-running or oil-lubricated pump). This results in item designations VZ-TR for dry-running and VZ-OG for oil-lubricated.

### 2.1 Technical Data of Vacuum Generators VZ

Type	Dry Running Pumps				
	VZ-TR-4 AC-5	VZ-TR-8 AC-5	VZ-TR-10 AC3-15	VZ-TR-25 AC-50	VZ-TR-25 AC3-50
Accumulator volume in dm <sup>3</sup> (litres)	5	5	15	50	50
Pump type	EVE-TR 4	EVE-TR 8	EVE-TR 10	EVE-TR 25	EVE-TR 25
Suction capacity in m <sup>3</sup> /h	4	8	10	25	25
Voltage in V	230	230	400	230	400
Mains frequency in Hz	50	50	50	50	50
Motor power in kW	0,2	0,35	0,37	0,80	0,75
Sound pressure level in dB	55	75	60	63	62

Type	Dry Running Pumps			
	VZ-TR-40 AC3-50	VZ-TR-80 AC3-100	VZ-TR-80 AC3-100 GMS	VZ-TR-80 AC3-100 MS
Accumulator volume in dm <sup>3</sup> (litres)	50	100	100	100
Pump type	EVE-TR 40	EVE-TR 80	EVE-TR 80	EVE-TR 80
Suction capacity in m <sup>3</sup> /h	40	80	80	80
Voltage in V	400	400	400	400
Mains frequency in Hz	50	50	50	50
Motor power in kW	1,5	3	3	3
Sound pressure level in dB	67	72	72	72

Type	Oil Lubricated Pumps		
	VZ-OG-63 AC3-100	VZ-OG-100 AC3-100	VZ-OG-165 AC3-200
Accumulator volume in dm <sup>3</sup> (litres)	100	100	200
Pump type	EVE-OG 63	EVE-OG 100	EVE-OG 165
Suction capacity in m <sup>3</sup> /h	63	100	165
Voltage in V	400	400	400
Mains frequency in Hz	50	50	50
Motor power in kW	1,5	2,2	4,0
Sound pressure level in dB	65	67	70



## 2.2 Dimensions

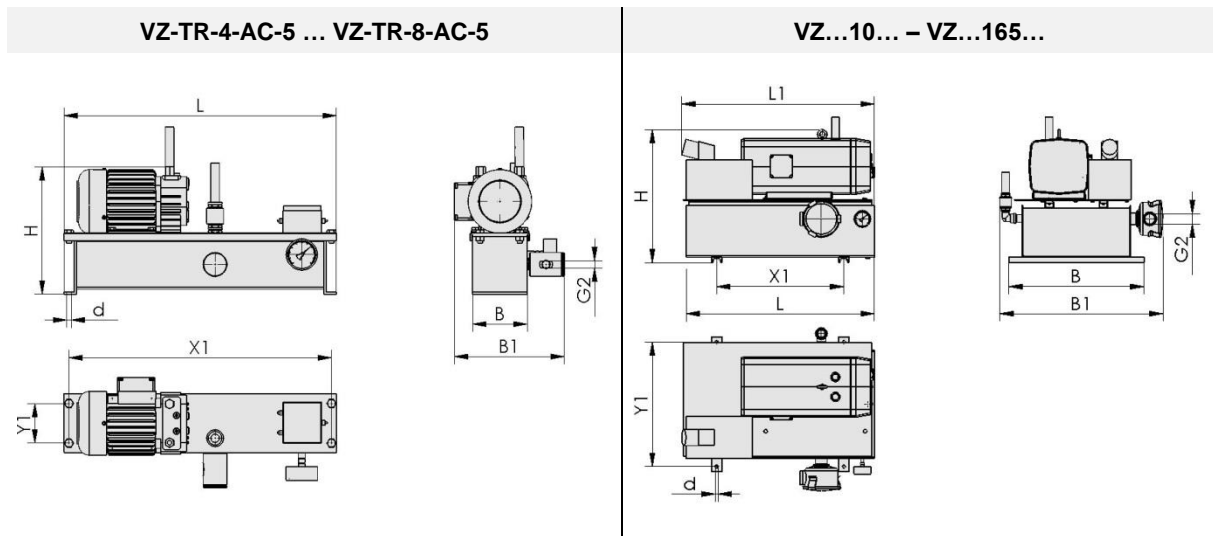

Typ	B	B1	d	G2	H	L	L1	X1	Y1
VZ-TR-4-5	120	224	9	G 3/8"	272	550	-	530	80
VZ-TR-8-5	120	224	9	G 3/8"	272	550	-	530	80
VZ-TR-10-15	400	490	11	G 3/4"	440	430	430	280	360
VZ-TR-25-50	510	630	11	G 1 1/4"	560	710	730	480	470
VZ-TR-40-50	510	630	11	G 1 1/4"	560	710	770	480	470
VZ-TR-80-...	610	720	11	G 1 1/4"	690	710	715	480	570
VZ-TR-80-...GMS	610	720	11	G 1 1/4"	690	710	715	480	570
VZ-TR-80-...MS	610	720	11	G 1 1/4"	690	710	715	480	570
VZ-OG-63-100	610	740	11	G 1 1/4"	695	710	750	480	570
VZ-OG-100-100	610	740	11	G 1 1/4"	695	710	780	480	570
VZ-OG-165-200	710	1010	11	G 2 1/2"	930	910	1000	592	670

## 2.3 Components of the Vacuum Generator

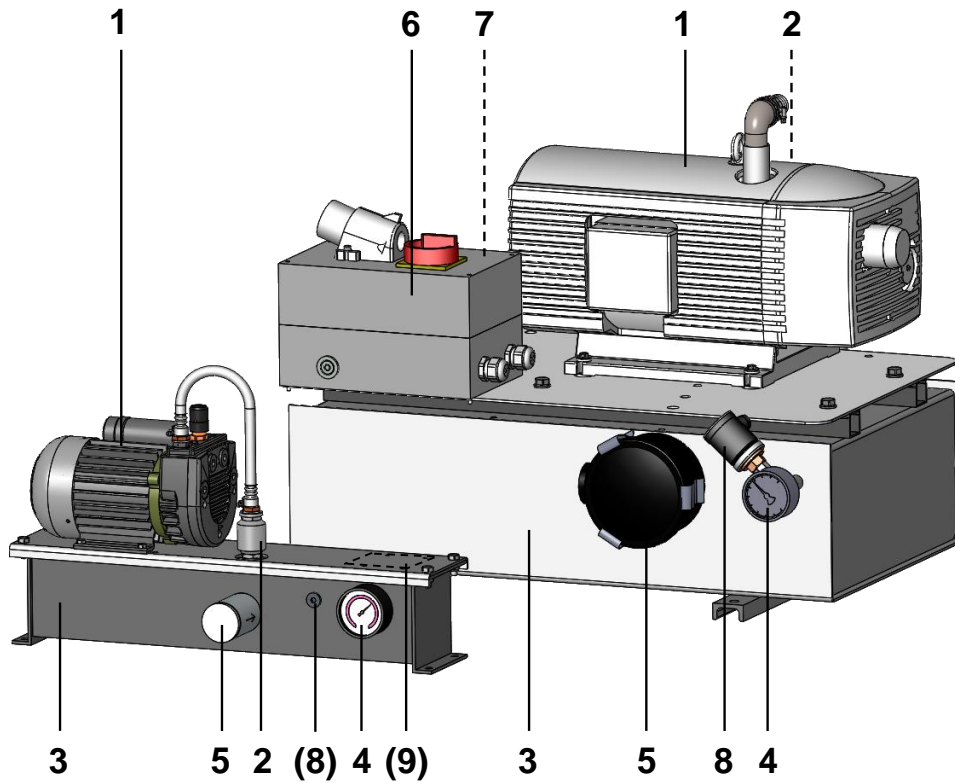

Pos.	Bezeichnung
1	Vacuum pump
2	<b>Non-return valve (not VZ 63 – 165)</b>
3	Vacuum accumulator
4	<b>Pressure gauge</b>
5	Vacuum filter
6	<b>Vacuum controlled motor operation with plug (optional)</b>
7	<b>Motor overload switch</b>
8	Vacuum switch (optional)
9	Clamping box vacuum control (optional)

Components serving safety functions are indicated by **bold type**.

## 2.4 Vacuum pump

Die Vakuumpumpe erzeugt das Vakuum für die Vakuum-Zentrale.

Der Pumpenmotor muss durch einen vorgeschalteten Motorschutzschalter vor Überlastung geschützt werden!

Bei Vakuum-Zentralen die mit Motorschutzschalter oder Unterdruckgeregelter Motorschaltung ausgestattet sind, ist der Motornennstrom ab Werk eingestellt.

<b>CAUTION</b>	
	<p><b>Pump motor overload</b></p> <p>High current flow resulting in destruction of the motor</p> <ul style="list-style-type: none"> <li>▶ Installation of a motor-protection switch</li> </ul>

## 2.5 Accessories Motor Overload Switch / Vacuum Controlled Motor Operation

The motor overload switch protects the pump motor from overload and serves as power switch. It is adjusted to the rated current consumption ex works.

The vacuum control automatically switches the vacuum pump on via a vacuum switch. When the maximum vacuum pressure is reached it switches the pump off again. Motor and pump thus do not have to run continuously.

The switching points are adjusted ex works.

# 3 Transport and Installation

## 3.1 Transport

The vacuum generator (VZ 10 - 165) can be lifted and located with a suitable hoist and lifting belts (observe the max. carrying capacity).

## 3.2 Installation site

The vacuum generator must not be operated in rooms with explosive atmosphere.

<b>! DANGER</b>	
	<p><b>Switching components not explosion-proof</b></p> <p>Risk of fire and explosion</p> <ul style="list-style-type: none"> <li>▶ The product must not be used in explosion risk areas</li> </ul>



The ambient temperature at the installation site must be between 0 °C and +40 °C (please contact the manufacturer prior to operation if this range is to be exceeded)

Ensure by internal instructions and checks that the installation site is totally clean and well organized



When operating in dusty surroundings the dust filter cartridge must be checked regularly and blown out or replaced when necessary.

### 3.3 Installation Procedure

 <b>WARNING</b>	
	<p><b>Installation by non-qualified personnel</b></p> <p>Danger to life and limb</p> <p>► Installation to be carried out only by qualified specialists (see 1.6)</p>

Screw the vacuum generator at the installation site. Use the fastening brackets on the accumulator or the holes in them.

Anschluss der elektrischen Versorgungsleitung:

Connecting the electrical power supply:



- Connect the cable to the vacuum generator according to local regulations. This work must be done by a qualified electrician.
- Power and current consumption are indicated on the name plate of the pump motor.
- On units without motor overload protection and without vacuum control observe the following: be sure the pump is protected by an external overload switch adjusted to the rated current.
- On units with motor overload switch observe the following: Connect power to the supply terminals of the motor overload switch. It is adjusted to the rated current ex works.
- On units with vacuum controlled motor operation observe the following: A 16A-CEKON plug is provided for connection to power.

#### 3.3.1 Checking the Oil Level

On oil lubricated pumps check the oil level at the oil window before starting operation, see operating instructions of the pump.

### 3.3.2 Checking the Rotation Direction of the Pump



<b>CAUTION</b>	
	<p><b>Pump motor running in the wrong direction</b></p> <p>Danger of destroying the motor</p> <ul style="list-style-type: none"> <li>▶ Correct rotational direction by reversing the polarity in the supply line</li> </ul>

<b>DANGER</b>	
  	<p><b>Electric voltage</b></p> <p>Danger of electric shock</p> <ul style="list-style-type: none"> <li>▶ Disconnect central vacuum unit from power supply</li> <li>▶ To be carried out only by qualified electrician</li> </ul>

On the types with three-phase motor check the rotation direction of the motor as follows:

- Switch on the pump.
- Watch the fan blades of the motor. They must turn in the direction indicated by the arrow on the motor housing. The unit is supplied with "right-hand field" operation.
- If the rotation direction is wrong immediately switch the unit off and swap the supply connections.
- Check again.

	<p>If the device is damaged by operation with the wrong rotation direction the warranty is voided.</p>
---	--

<b>WARNING</b>	
  	<p><b>Strong suction after startup of central vacuum unit</b></p> <p>Hair clothing and eyes can be drawn in</p> <ul style="list-style-type: none"> <li>▶ Do not look into the opening of the suction connection</li> <li>▶ Wear protective glasses</li> <li>▶ Wear head protection</li> </ul>

### 3.3.3 Safety feature

As a safety feature, the central vacuum unit is equipped with a pressure gauge indicating a red danger range indicator.

	<p>Check the tightness of the generator at the beginning of each shift (when operating in shifts) or once a week (when operating continually).</p>
---	--

#### Central vacuum unit check-up

Switch on the vacuum pump and wait until the vacuum is build up.  
 Switch off the vacuum generator and watch the pressure gauge.  
 The drop of the vacuum pressure must not exceed 0.1 bar per minute.



Correct faults before operating the device. If faults occur during operation, switch the device off and correct the faults before continuing work with the device.

## 4 Operation

Local applicable safety regulations must be observed



The company must ensure by internal measures



- that the operators of the vacuum generator are properly trained,
- that they have read and understood the operating instructions, and
- that the operating instructions will be available to them at any time.

The responsibilities for the tasks carried out with the device must be clearly organized and observed. Ambiguity regarding responsibilities must not exist.

The following note is a supplement to local applicable safety regulations:

- Regularly check the pressure gauge.  
If the pressure gauge needle reaches the red area below -0.6 bar, there is a risk that the supplied suction pads can no longer safely hold the lifted load.  
Checking device for leaks

 <b>DANGER</b>	
 	<p><b>Insufficient vacuum supply of the device</b> Lifted load can no longer be held safely</p> <ul style="list-style-type: none"> <li>▶ Complete the work step as safely as possible</li> <li>▶ Shut down supply</li> <li>▶ Check device for leaks</li> </ul>

 <b>WARNING</b>	
 	<p><b>Strong suction after startup of central vacuum unit</b> Hair clothing and eyes can be drawn in</p> <ul style="list-style-type: none"> <li>▶ Do not look into the opening of the suction connection</li> <li>▶ Wear protective glasses</li> <li>▶ Wear head protection</li> </ul>

### 4.1 Switching On / Off

On units with a motor overload switch the switch also serves as the power switch to turn the unit on and off.

On units with vacuum controlled motor operation a power switch is provided with the control unit.

When the power switch is on the vacuum pump is switched on automatically by a vacuum switch. It is automatically switched off when the maximum vacuum pressure is reached.

## 5 Maintenance

The device must be installed and maintained by qualified personnel, mechanics and electricians. After each repair or maintenance work be sure to check the guards.

### 5.1 Vacuum Pump

See the operating instruction of the vacuum pump

### 5.2 Filter

Check and blow out the filter cartridge (from inside out) depending on the amount of dust around but at least once a week.

When the cartridge is choked replace it.





When you pull out the filter cartridge be sure not to allow dust to fall into the suction opening.

### 5.3 Adjusting the Vacuum Controlled Motor Operation

The control unit is provided with a vacuum switch that switches the motor off when the maximum vacuum is reached. If the vacuum inside the accumulator decreases by 100-150 mbar, the motor is switched on again. The maximum vacuum can be adjusted with the adjusting screw on the vacuum switch.

It is adjusted to 700-750 mbar ex works.

 <b>DANGER</b>	
 	<p><b>Maximum vacuum adjusted improperly</b></p> <p>Danger of electric shock</p> <ul style="list-style-type: none"> <li>▶ Shut down supply</li> <li>▶ Work steps must be carried by qualified specialists as described</li> </ul>

The switching point may be adjusted only by a qualified electrician.

**Procedure:**

- The vacuum centre must be completely disconnected from the AC mains supply.
- Open the housing of the vacuum switch with a suitable screwdriver.
- Slightly adjust the switching point of the vacuum switch.
- Close the housing of the vacuum switch.
- Connect the vacuum centre to the AC mains supply and check the new setting with the aid of the manometer.

If necessary, repeat steps 1-5 until the switching point is correct.

The maximum vacuum is limited by the pump's capacity, that is, above a certain value the pump will not switch off at all anymore, since the preadjusted vacuum cannot be reached.

## 5.4 Trouble Shooting, Remedy

The device must be installed and maintained by qualified personnel, mechanics and electricians. After each repair or maintenance work be sure to check the guards.

Error	Cause	Remedy
Pump does not run	Electrical connection wrong or defective	Check, if necessary correct connection
	Version witch motor overload switch: motor overload switch tripped	<ul style="list-style-type: none"> <li>● Check motor for defect, thermal overload</li> <li>● Clean the dust filter</li> <li>● Let the motor cool down</li> <li>● Adjust the current of switch if necessary</li> <li>● Turn on the switch</li> </ul>
	Power on two phases only	Check fuses and connection.
	Power failure	Check power supply line.
Pump runs, but vacuum pressure of -0.6 bar is not reached	Motor rotation direction wrong, filter cover not tight	Transpose power connection, check filter cover for tightness.
	Plug on the accumulator not tight	Tighten plug, replace seal ring.
	Filter cover not tight	Check the filter cover on tightness.
	screwed connections not tight	Check and retighten screwed connections and replace seal rings if necessary.

## 6 Guarantee, spare- and consumable parts

This equipment is guaranteed in accordance with our General Conditions of Business. This also applies to spare parts where these are original parts supplied by us. We will assume no liability for damage caused by the use of non-original spare parts and accessories. Wear and consumable parts are not covered by the guarantee.



## 6.1 Spare- and consumable parts

Description	Type						Legend	
	VZ-TR-4- ...	VZ-TR-8- ...	VZ-TR-10- ...	VZ-TR-25- AC...	VZ-TR-25- AC3...	VZ-TR-40- ...		VZ-TR-80- ...
Consumable part set for pump (7x vane, 1x filter cartridge)	10.03.01.00108	10.03.01.00109	10.03.01.00132	10.03.01.00134		10.03.01.00135	22.09.01.00031	V
Non-return valve RSV	10.05.05.00002		10.05.05.00003	10.05.05.00004			10.05.05.00006	E
Vacuum filter STF	10.07.01.00004		10.07.01.00007	10.07.01.00008				VB
Spare filter cartridge	10.07.01.00014		10.07.01.00017	10.07.01.00018				V
Vacuum switch	10.06.02.00269							E
Vacuum pressure gauge VAM	10.07.02.00003							E

Description	Type			Legend
	VZ-OG-63-...	VZ-OG-100-...	VZ-OG-165-...	
Oil spare filter cartridge	10.03.02.00009	10.03.02.00009	10.03.02.00011	V
Air spare filter cartridge	10.03.02.00012	10.03.02.00012	10.03.02.00013	V
Vacuum pressure gauge VAM	10.07.02.00003			E
Vacuum filter STF	10.07.01.00008		10.07.01.00010	VB
Spare filter cartridge	10.07.01.00018		10.07.01.00020	V
Vacuum switch	10.06.02.00269			E

**E** = Spare part,      **V** = Consumable part,      **VB** = Consumable-part assembly, contains consumable parts

## 6.2 Nameplate

On the nameplate the main data for the vacuum generator is indicated. The nameplate is firmly connected to the device. Its position is shown in the "Spare parts list". The nameplate contains the following information



- ← Type
- ← Device number
- ← Order number
- ← Year of construction
- ← Max. lifting capacity
- ← Weight of device

## 6.3 Decommissioning

After being exchanged or after final decommissioning, the central vacuum unit, as well as the components and assemblies that were replaced, are to be disposed of in accordance with country-specific guidelines.

<b>CAUTION</b>	
	<p><b>Incorrect disposal of the vacuum generator</b></p> <p>Environmental damage</p> <ul style="list-style-type: none"> <li>▶ Disposal according to country-specific guidelines</li> </ul>

## 7 Applicable documents

Vacuum generator	Manual of the pump
VZ-TR-4	30.30.01.00130
VZ-TR-8	30.30.01.00130
VZ-TR-10	30.30.01.00121
VZ-TR-25	30.30.01.00121
VZ-TR-25-AC3	30.30.01.00121
VZ-TR-40	30.30.01.00121
VZ-TR-80	30.30.01.00120
VZ-OG-63	30.30.01.00003
VZ-OG-100	30.30.01.00003
VZ-OG-165	30.30.01.00004

# 8 Conformity Declaration

DE EU-Konformitätserklärung  
 EN EC- Declaration of Conformity  
 FR CE-Déclaration de conformité



Hersteller / Manufacturer / Fabricant

J. Schmalz GmbH, Johannes-Schmalz-Str. 1, D - 72293 Glatten

Produktbezeichnung / Product name / Designation du produit

VZ

Vakuumpumpen der Serie / Vacuum generators, Series /  
 Générateurs à vide, série

Erfüllte einschlägige EU-Richtlinien / Applicable EC directives met / Directives CE applicables respectées

2006/42/EG	Maschinenrichtlinie / Machinery Directive / Directive sur les machines / Directiva para máquinas / Direttiva macchine / Machinerichtlijn
2014/30/EU	Elektromagnetische Verträglichkeit / Electromagnetic Compatibility / Compatibilité électromagnétique / Compatibilidad electromagnética / Compatibilità elettromagnetica / Elektromagnetische compatibilität
2014/35/EU	Niederspannungsrichtlinie / Low Voltage Directive / Directive basse tension / Directiva de baja tensión / Direttiva sulla bassa tensione / Laagspanningsrichtlijn

Angewendete harmonisierte Normen / Harmonised standards applied / Normes d'harmonisation appliquées

EN ISO 12100	Sicherheit von Maschinen - Grundbegriffe, allgemeine Gestaltungsleitsätze - Risikobeurteilung / Safety of Machinery - Basic concepts, general principles for design - Risk assessment / Sécurité des machines - Notions fondamentales, principes généraux de conception - Appréciation du risque
EN 60204-1 EN 60204-32	Sicherheit von Maschinen - Elektrische Ausrüstung von Maschinen / Safety of Machinery - Electrical equipment of machines / Sécurité des machines - Équipement électrique des machines
EN 61000-6-3	Elektromagnetische Verträglichkeit - Störaussendung / Electromagnetic Compatibility - Emission / Compatibilité électromagnétique - Norme sur l'émission
EN 61000-6-2	Elektromagnetische Verträglichkeit - Störfestigkeit / Electromagnetic Compatibility - Immunity / Compatibilité électromagnétique - Immunité
EN ISO 2151	Akustik- Kompressoren und Vakuumpumpen, Bestimmung der Geräuschemission / Acoustics - Noise test code for compressors and vacuum pumps / Acoustique - Code d'essai acoustique pour les compresseurs et les pompes à vide

Dokumentationsverantwortlicher / Person responsible for documentation / Responsable de la documentation

Glatten, 17.08.2017

/ i.A.

Klaus-Dieter Fanta, J. Schmalz GmbH, Johannes-Schmalz-Str. 1, D - 72293 Glatten

Unterschrift, Angaben zum Unterzeichner / Signature, details of signatory / Signature, indications sur le soussigné

Glatten, 17.8.17

Walter Dunkmann  
 Leiter Geschäftsfeld, Vakuumpumpen /  
 Head of Business Unit, Vacuum Automation

## Schmalz Services



### Global contact

Our sales network of local field representatives, international subsidiaries and trade partners ensures quick and competent information and consultation in more than 50 countries worldwide.

 [www.schmalz.com/salesnetwork](http://www.schmalz.com/salesnetwork)



### Online documentation

Conveniently download catalogs, operating instructions and CAD data and get comprehensive information about our products and services.

[www.schmalz.com/dokumentationen](http://www.schmalz.com/dokumentationen)  





### “How-to” videos

In short, easy-to-understand videos we explain the comprehensive functions offered by our products. Take a look, it's worth it!

 [www.schmalz.com/gewusst-wie](http://www.schmalz.com/gewusst-wie)

Further services ranging from consultation to training can be found at

 [www.schmalz.com/services](http://www.schmalz.com/services)