

Vacuum pump

EVE-TR 100 AC3/S070 IE2

<https://www.schmalz.com/10.03.01.00257>



Part no.: 10.03.01.00257

Homepage > Vacuum Technology for Automation > Vacuum Components > Vacuum Generators > Vacuum Pumps > Dry-Running Vacuum Pumps
EVE-TR > EVE-TR 100 AC3/S070 IE2

Oil-free pump with constant suction rate, robust, requires little maintenance



Current type: 3-phase AC
 Noise level (50 Hz): 75 dB
 Voltage (50 Hz):
 D200V/Y350V $\pm 10\%$ (w/oIE2)
 Voltage (60 Hz): D220V/Y380-400V $\pm 10\%$
 Voltage (60 Hz-opt):
 D200V/Y350V $\pm 10\%$ (w/oIE2)
 Suction rate (50 Hz): 98 m³/h
 Suction rate (60 Hz): 112 m³/h
 Vacuum (50Hz): -900 mbar
 Permission: IE2
 Rated power (50 Hz): 3 kW
 Rated power (60 Hz): 3.6 kW
 Weight: 100 kg

Design Data

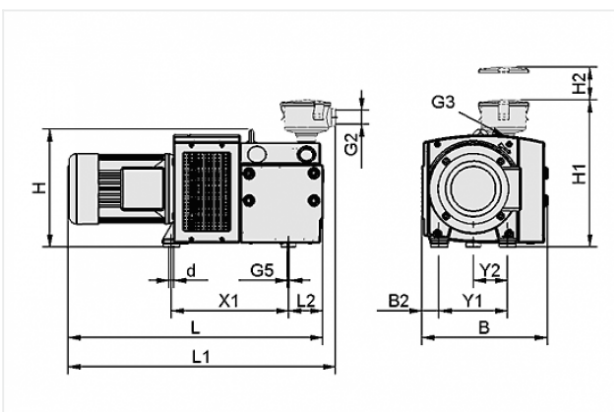

Attribute	Value
B	470 mm
B2	110 mm
d	12 mm
G3	G1-1/2"-F
G5	M8-F
H	336 mm
L	835 mm
L2	140 mm
X1	398 mm

Contact to Schmalz

J. Schmalz GmbH | Johannes-Schmalz-Straße, 72293 Glatten, Deutschland | +49 7443 2403-102 | customercenter@schmalz.de



Attribute	Value
Y1	245 mm
Y2	122.5 mm

Technical Data

Attribute	Value
Suction rate (50 Hz)	98 m ³ /h
Suction rate (60 Hz)	112 m ³ /h
Voltage (50 Hz)	D200V/Y350V ±10% (w/oIE2)
Voltage (60 Hz)	D220V/Y380-400V ±10%
Rated power (50 Hz)	3 kW
Rated power (60 Hz)	3.6 kW
Current type	AC3
Noise level (50 Hz)	75 dB
Weight	100 kg
Protection	IP 55

Contact to Schmalz