

技術資料 Technische Documentatie **Documentation**
Documentação técnica Documentación técnica Documentazione tecnica
Technische Dokumentation Technical Documentation Техническая
Documentazione tecnica Technische documentatie ДОКУМЕНТАЦИЯ
Техническая документация **Teknik Doküman** 技术资料
Documentazione tecnica Dokumentacja techniczna
Technische documentatie Documentación técnica **技術資料**
기술 자료 Technische documentatie **技術資料**
Documentation technique Teknik Doküman Dokumentacja techniczna
Technical Documentation **Documentazione tecnica** Technical Documentation
Dokumentacja techniczna 技术资料 Documentation technique
Техническая документация Technische Dokumentation **Teknik Doküman**
Dokumentacja techniczna Technische documentatie
Documentation technique 기술 자료 Dokumentacja techniczna



ECBPi CobotPump

Operating Instructions

Note

The operating instructions were originally written in German and have been translated into English. Store in a safe place for future reference. Subject to technical changes without notice. No responsibility is taken for printing or other types of errors.

Published by

© J. Schmalz GmbH, 07/18

This document is protected by copyright. J. Schmalz GmbH retains the rights established thereby. Reproduction of the contents, in full or in part, is only permitted within the limits of the legal provisions of copyright law. Any modifications to or abridgments of the document are prohibited without explicit written agreement from J. Schmalz GmbH.

Contact

J. Schmalz GmbH

Johannes-Schmalz-Str. 1

72293 Glatten, Germany

T: +49 7443 2403-0

schmalz@schmalz.de

www.schmalz.com

Contact information for Schmalz companies and trade partners worldwide can be found at:

www.schmalz.com/salesnetwork

Contents

1	Important information	8
1.1	Note on using these operating instructions	8
1.2	The technical documentation is part of the product	8
1.3	Warnings in this document	8
1.4	Symbol	8
2	Fundamental Safety Instructions	9
2.1	Standards of Technology	9
2.2	Intended Use	9
2.3	Safety Instructions	9
2.4	Changes to the Vacuum Generator	10
2.5	Personnel Qualification	10
2.6	Personal Protective Equipment	10
3	Product description	11
3.1	Design of the CobotPump	11
3.2	Variants of the CobotPump	11
3.3	Description of Functions	12
3.3.1	Lifting the Workpiece	12
3.3.2	Depositing the Workpiece	12
3.3.3	Control Scheme	12
3.3.4	IO-Link and NFC Interface	13
3.4	Display and Control Elements	14
3.4.1	Description of the Display and Control Element	14
3.4.2	LED State Indicators	14
4	Technical Data	16
4.1	Electrical Parameters	16
4.2	Display Parameters	16
4.3	Mechanical Data	17
4.3.1	General Parameters	17
4.3.2	Mechanical Performance Data	17

4.3.3	Dimensions.....	18
4.3.4	Maximum Torque	18
5	Operating and Menu Design.....	19
5.1	Button Assignments in Display Mode	19
5.1.1	Opening the Menu	19
5.1.2	Display Supply Voltages and Temperatures.....	20
5.1.3	Display Operating Mode	20
5.2	Main Menu	20
5.2.1	Functions in the Main Menu.....	20
5.2.2	Changing the Parameters of the Main menu	20
5.3	Configuration Menu	21
5.3.1	Functions in the Configuration Menu.....	21
5.3.2	Changing the Parameters of the Configuration Menu.....	22
5.4	System Menu	23
5.4.1	Functions in the System Menu.....	23
5.4.2	Viewing Data in the System Menu	23
6	Description of Functions.....	24
6.1	Overview of Functions	24
6.2	Operating Modes	25
6.2.1	Automatic Operation	25
6.2.2	Manual Mode	25
6.3	Monitoring the System Vacuum and Defining Limit Values	26
6.4	Calibrating the Vacuum Sensor	27
6.5	Control Function.....	27
6.5.1	Sustained Suction	28
6.5.2	Control	28
6.6	Blowoff Modes	29
6.6.1	Externally Controlled Blowoff	29
6.6.2	Internally Time-controlled Blowoff	29
6.6.3	Externally Time-controlled Blowoff	29

6.6.4	Setting the Blowoff Time	29
6.7	Soft Start	29
6.8	Output and Input Functions	30
6.8.1	Signal Outputs	30
6.8.2	Signal Inputs	30
6.8.3	Signal Type	30
6.9	Select Vacuum Unit	30
6.10	Switch-off Delay	31
6.11	Rotating the Display	31
6.12	ECO Mode	31
6.13	Locking and Unlocking the Menus	32
6.13.1	PIN Code	32
6.13.2	Restricting Access Using Device Access Locks	32
6.13.3	Unlocking the Menus	32
6.14	Resetting to Factory Settings (Clear All)	33
6.15	Counter(s)	34
6.16	Displaying the Software Version	34
6.17	Displaying the Part Number	35
6.18	Displaying the Serial Number	35
6.19	Error Display	35
6.20	Temperature Display	35
6.21	Monitoring of the Supply Voltages	36
6.22	Energy and Process Control (EPC)	36
6.22.1	Condition Monitoring (CM)	36
6.22.2	Energy Monitoring (EM)	39
6.22.3	Predictive Maintenance (PM)	39
6.23	Production Setup Profiles	40
6.24	Device Data	41
6.25	User-Specific Localization	41
7	Transport and storage	42

7.1	Checking the Delivery	42
8	Installation.....	43
8.1	Installation Instructions.....	43
8.2	Mechanical Attachment.....	43
8.3	Electrical Connection.....	44
8.3.1	Description of the Electrical Connection.....	44
8.3.2	Mounting the Connection Cable	46
8.4	Start of Operations.....	47
9	Operation	48
9.1	Preparations.....	48
9.2	Operating Modes	48
9.2.1	SIO Operating Mode	48
9.2.2	IO-Link Operating Mode.....	49
10	Maintenance.....	50
10.1	Safety	50
10.2	Cleaning the Device	50
10.3	Cleaning the Sieve Insert	50
10.4	Replacement of the Device with a Parameterization Server.....	50
11	Warranty.....	51
12	Spare and Wearing Parts, Accessories.....	52
12.1	Spare and Wearing Parts	52
12.2	Accessories	52
13	Troubleshooting.....	53
13.1	Error Messages in SIO Operation.....	53
13.2	Warnings and Error Messages in IO-Link Mode	53
13.3	Troubleshooting	54
14	Decommissioning and recycling	56
14.1	Disposing of the Device	56
15	Appendix	57
15.1	Factory Settings	57

15.2 Overview of Display Symbols.....	57
15.2.1 Showing the Seven-segment Display in the Basic Menu.....	57
15.2.2 Showing the Seven-segment Display in the Configuration Menu	58
15.2.3 Showing the Seven-segment Display in the System Menu	59
15.3 ECBPI_CobotPump_ Data Dictionary_00.PDF.....	60
15.4 ECBPi_CE_30.30.01.01452-01_DE-EN-FR-ES-IT-NL.pdf	65

1 Important information

1.1 Note on using these operating instructions

The J. Schmalz GmbH is generally referred to as Schmalz in these operating instructions.

These operating instructions contain important notes and information about the different operating phases of the product:

- Transport, storage, start of operations and decommissioning
- Safe operation, required maintenance, rectification of any faults

The operating instructions describe the product at the time of delivery by Schmalz.

1.2 The technical documentation is part of the product

1. For problem-free and safe operation, follow the instructions in the documents.
 2. Keep the technical documentation in close proximity to the product. The documentation must be accessible to personnel at all times.
 3. Pass on the technical documentation to subsequent users.
- ⇒ Schmalz is not liable for damage or malfunctions that result from failure to heed these instructions.

If you still have questions after reading the technical documentation, contact the Customer Service Center on:

www.schmalz.com/services

1.3 Warnings in this document

Warnings warn against hazards that may occur when handling the product. There are four levels of danger that you can recognize by the signal word.

Signal word	Meaning
DANGER	Indicates a high-risk hazard which, if not avoided, will result in death or serious injury.
WARNING	Indicates a medium-risk hazard which, if not avoided, could result in death or serious injury.
CAUTION	Indicates a low-risk hazard which, if not avoided, could result in minor or moderate injury.
REFERENCE NOTE	Indicates a danger that leads to property damage.

1.4 Symbol



This sign indicates useful and important information.

- ✓ This symbol represents a prerequisite that must be met before installation and maintenance work.
- ▶ This sign represents an action to be performed.
- ⇒ This sign represents the result of an action.

Actions that consist of more than one step are numbered:

1. First action to be performed.
2. Second action to be performed.

2 Fundamental Safety Instructions

2.1 Standards of Technology

The CobotPump is state of the art and operationally reliable as delivered. The operating instructions contain important information on using the system.



NOTE

Damage to plants and systems

- ▶ Read the instructions closely and keep them for later use.

2.2 Intended Use

The CobotPump is designed to generate a vacuum for gripping and transporting objects when used in conjunction with suction cups. The pump is designed to be connected to a PLC. The signals are transmitted discretely or via IO-Link.

It has been specially developed for use in collaborative robot systems.

Neutral gases in accordance with EN 983 are approved as evacuation media. Neutral gases include air, nitrogen and inert gases (e.g. argon, xenon and neon).

The product is intended for industrial use.

Intended use includes the observance of the technical data and the installation and operating instructions in this manual.

2.3 Safety Instructions



⚠ DANGER

Risk of fire and explosion caused by sparks

Serious injury or death!

- ▶ Do not use the CobotPump in environments where there is a risk of explosion.



⚠ CAUTION

Vacuum close to the eye

Severe eye injury!

- ▶ Wear eye protection.
- ▶ Do not look into vacuum openings, e.g. suction cups.



⚠ WARNING

Extraction of hazardous media, liquids or bulk material

Personal injury or damage to property!

- ▶ Do not extract harmful media such as dust, oil mists, vapors, aerosols etc.
- ▶ Do not extract aggressive gases or media such as acids, acid fumes, bases, biocides, disinfectants or detergents.
- ▶ Do not extract liquids or bulk materials, e.g. granulates.

2.4 Changes to the Vacuum Generator

Schmalz assumes no liability for consequences of modifications over which it has no control:

1. The vacuum generator must be operated only in its original condition as delivered.
2. Use only original spare parts from Schmalz.
3. The vacuum generator may be operated only in perfect condition.

2.5 Personnel Qualification

Unqualified personnel cannot recognize dangers and are therefore exposed to higher risks!

1. Only instruct qualified personnel to perform the tasks described in this manual.
2. The product may only be operated by persons who have undergone appropriate training.
3. Electrical work and installations may only be carried out by qualified electrical specialists.
4. Assembly and maintenance work may only be carried out by qualified personnel.

The following target groups are addressed in this manual:

- Installers who are trained in handling the product and can operate and install it
- Technically trained service personnel performing the maintenance work
- Technically trained persons who work on electrical equipment

2.6 Personal Protective Equipment

Always use suitable and appropriate protective equipment that suits the situation to avoid injury:

- Eye protection (class F)
- Hair net
- Closely fitting clothing

3 Product description

3.1 Design of the CobotPump

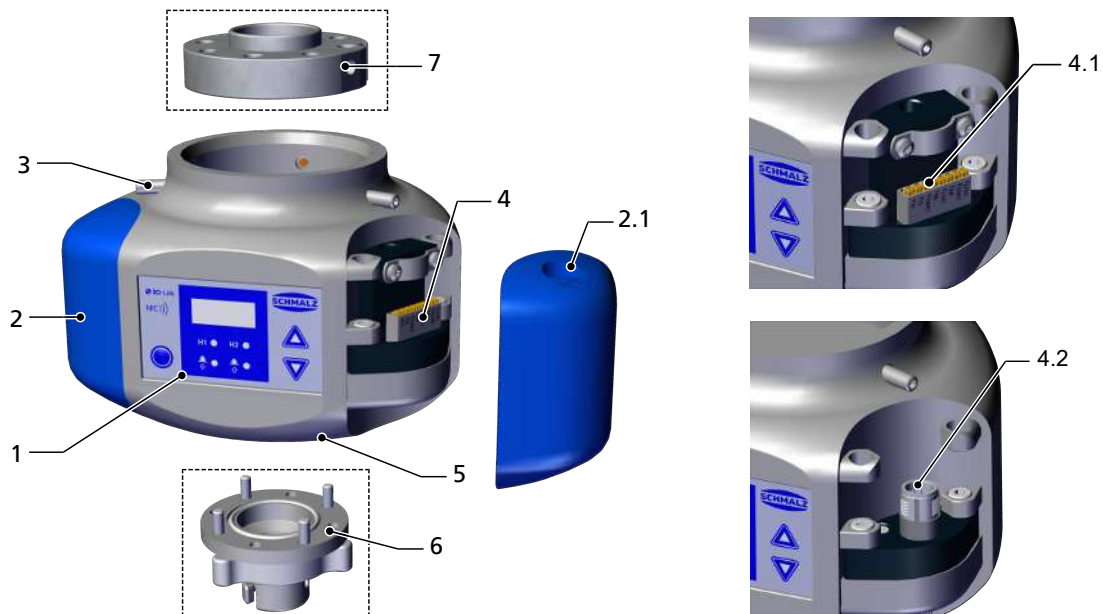

1	Operating and display elements	2	Shock protection "bumper"
3	Set screw (3x) for mounting the flange plate [7], max. tightening torque 0.6 Nm	2.1	Cable duct prepared
5	Vacuum opening	4	Electrical connection
7	Optional: flange plate (mechanical interface for collaborative robots)	4.1	Version with connection terminal, 8-pin (ECBPI 24V DC TB-8)
		4.2	Version with M12 connector, 8-pin (ECBPI 24V DC M12-8)
		6	Optional: flange module (mechanical interface for vacuum end effector VEE)

3.2 Variants of the CobotPump

The CobotPump (vacuum generator designated ECBPi) is available in two different versions. The version is indicated in the item designation. The item designation is composed as follows:

Type	Suction capacity l/min	Voltage	Electrical connection
ECBPI 24V-DC M12-8	1-12 (adjustable)	DC 24V	M12-8 1 M12, 8-pin plug
ECBPI 24V-DC TB-8	1-12 (adjustable)	DC 24V	TB-8 Terminal block with 8 terminals

The behavior of the electrical inputs and outputs can be set on the device (PNP or NPN) and therefore does not depend on the version. The factory setting of the device is PNP.

3.3 Description of Functions

3.3.1 Lifting the Workpiece

The CobotPump is designed for vacuum handling of parts in combination with suction systems.

The electrical pump is activated and deactivated via the suction signal input.

On the NC (normally closed) version, the pump is activated when a signal is applied to the "Suction" input.

An integrated sensor measures the vacuum generated by the pump. The measurement is electronically evaluated, shown on the display and output via IO-Link process data. The measurement value forms the basis for the energy saving feature, switching the output OUT2, and the EPC (energy and process control) analysis functions.

The CobotPump has an integrated energy saving feature. When the machine is in the "Suction" operating mode, it automatically controls the vacuum to keep it at the user-configured limit value H1.



If the volume to be evacuated is small, then the set limit value H1 may be exceeded before the vacuum is switched off. This system behavior does not constitute an error.

If leakage causes the system vacuum to drop about 10 percent below the limit value H1, then the pump is switched on again.

The display and control element (with integrated LED status displays) shows the current process states, such as the current vacuum level. In SIO operation, the parameter data may be displayed and modified.

The supply voltages are monitored by the electronics.

- If the supply voltages fall below approx. 19.2 V, this is indicated by an error message. Below this voltage threshold, it cannot be guaranteed that the device will operate as intended.
- The upper limit of permissible supply voltages is about 26.4 V. If the device is subjected to higher voltage, then an error message is displayed.

3.3.2 Depositing the Workpiece

In the Blowoff operating state, the vacuum circuit of the CobotPump is vented toward the atmosphere. This ensures that the vacuum drops immediately and the workpiece is deposited quickly. Blowoff mode can be controlled externally or internally.

- In "externally time-controlled (automatic) blowoff", the Blowoff operating state is activated by a signal being applied to the corresponding signal input for a set duration.
- In "internally time-controlled blowoff", the "blowoff" valve is automatically actuated and opened for a defined period after Suction mode is exited.

To allow error-free blowoff, the vent on the underside may not be covered or blocked.

3.3.3 Control Scheme

The controls of the CobotPump are defined in such a way that, if both inputs are activated at the same time, blowoff has priority over suction.

3.3.4 IO-Link and NFC Interface

IO-Link interface

The CobotPump can be operated in IO-Link mode to enable intelligent communication with a controller. The CobotPump's parameters can be set remotely using IO-Link mode. In addition, the energy and process control (EPC) feature is available. The EPC is divided into 3 modules:

- Condition monitoring (CM): Condition monitoring to increase system availability
- Energy monitoring (EM): Energy monitoring to optimize the vacuum system's energy consumption
- Predictive maintenance (PM): Predictive maintenance to increase the performance and quality of the gripping systems

NFC interface

NFC (Near Field Communication) refers to a standard for wireless data transfer between different devices over short distances.

The CobotPump functions as a passive NFC tag that can be read by a reading device such as a smart phone or tablet with NFC activated. Access to the CobotPump's parameters via NFC also works when the supply voltage is not connected.

There are two options for communicating via NFC.

- Read access only can be obtained via a website viewed in a browser. For this, no additional app is needed. It requires only that NFC and the internet connection are enabled.
- Another option for communication is the "Schmalz ControlRoom" control and service app. This permits not only read access but also active reconfiguration of the CobotPump's parameters via NFC. The Schmalz ControlRoom app is available at the Google Play Store.

For the best data connection, set the reading device on the middle of the control and display element of the CobotPump.

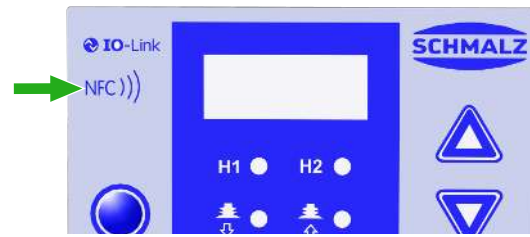

The reading distance is very short for NFC applications. Determine the position of the NFC antenna in the reading device used. If parameters of the device are modified via IO-Link or NFC, then the power supply must subsequently remain stable for at least three seconds to prevent data loss (error E01).

3.4 Display and Control Elements

3.4.1 Description of the Display and Control Element

The CobotPump is operated using 3 buttons, the 3-digit display, and 4 LEDs for giving status information. Additional information may be called up via the NFC interface.

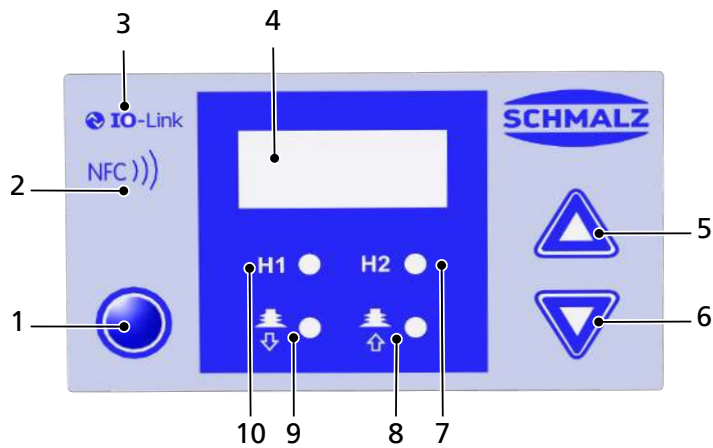



1	MENU BUTTON	2	NFC symbol (product is equipped with an NFC interface)
3	IO-Link symbol (product is equipped with an IO-Link interface)	4	Display
5	UP BUTTON	6	DOWN BUTTON
7	H2 limit value LED	8	LED process state: "Suction"
9	LED process state: "Blowoff"	10	H1 limit value LED

The buttons are used for navigating the various menus.





3.4.2 LED State Indicators

The CobotPump is equipped with two LEDs for indicating the "Suction" [8] and "Blowoff" [9] states. The table below explains the meaning of the LEDs.

Process state LEDs	CobotPump state
	LEDs both off CobotPump in standby mode
	"Suction" LED lit steadily CobotPump in suction state or being controlled
	"Blowoff" LED lit steadily CobotPump vented toward atmosphere

During suction cycles, the LEDs "H2" [7] and "H1" [10] for the H2 and H1 limit values show the current level of the vacuum in the system in relation to the set limit values H2 and H1. The display is independent of the control function and the assignment of the output. It is also independent of any active condition monitoring function.

The table below explains the meaning of the LEDs.

Limit value LEDs		CobotPump state
	LEDs both off	Rising vacuum: Vacuum < H2 Falling vacuum: Vacuum < (H2-h2)
	H2 LED lit steadily	Rising vacuum: Vacuum > H2 and < H1 Falling vacuum: Vacuum > (H2 - h2) and < (H1 - 10%)
	Both LEDs lit steadily	Rising vacuum: Vacuum > H1 Falling vacuum: Vacuum > (H1 - 10%)
	Both LEDs flashing	CobotPump in "manual mode"

4 Technical Data

4.1 Electrical Parameters

Parameter	Symbol	Limit values			Unit	Note
		min.	typ.	max.		
Power supply for sensor	U_S	20.9	24	26.4	V_{DC}	PELV ¹⁾
Power supply for actuator	U_A	20.9	24	26.4	V_{DC}	PELV ¹⁾
Rated current from U_S	I_S	—	100	—	mA	$U_S = 24.0 V$
Rated current from U_A	I_A	—	500	600 ²⁾	mA	$U_A = 24.0 V$
Voltage of signal output (PNP)	U_{OH}	$U_S - 2$	—	U_S	V_{DC}	$I_{OH} < 140 mA$
Voltage of signal output (NPN)	U_{OL}	0	—	2	V_{DC}	$I_{OL} < 140 mA$
Current of signal output (PNP)	I_{OH}	—	—	140	mA	Short-circuit-proof ³⁾
Current of signal output (NPN)	I_{OL}	—	—	-140	mA	Short-circuit-proof ³⁾
Voltage of signal input (PNP)	U_{IH}	15	—	U_A	V_{DC}	In reference to GND_A
Voltage of signal input (NPN)	U_{IL}	0	—	9	V_{DC}	In reference to U_A
Current of signal input (PNP)	I_{IH}	—	5	—	mA	—
Current of signal input (NPN)	I_{IL}	—	-5	—	mA	—
Reaction time of signal inputs	t_i	—	3	—	ms	—
Reaction time of signal outputs	t_o	1	—	200	ms	Adjustable

1) The supply voltages must correspond to the regulations in accordance with EN60204 (protected extra-low voltage). The signal inputs and outputs are all protected against reverse polarity.

2) For a short time ($t < 200 ms$), current pulses of max. 2 A occur.

3) The signal outputs are short-circuit-proof. However, the signal outputs are not protected against overloading. Constant load currents of $> 0.15 A$ can lead to impermissible heating and subsequent functional failure of the CobotPump.

4.2 Display Parameters

Parameter	Value	Unit	Note
Display	3	Digit	Red 7-segment LED display
Resolution	± 1	mbar	—
Accuracy	± 3	% FS	$T_{amb} = 25^\circ C$, based on FS final value (full-scale)
Linearity error	± 1	%	—
Offset error	± 2	mbar	After zero-point adjustment, without vacuum
Temperature influence	± 3	%	$5^\circ C < T_{amb} < 50^\circ C$
Display refresh rate	5	1/s	Only affects the 7-segment display
Idle time before the menu is exited	1	min	The display mode is accessed automatically when no settings are made in a menu.

4.3 Mechanical Data

4.3.1 General Parameters

Parameter	Symbol	Limit values			Unit	Note
		min.	typ.	max.		
Temperatures of working medium and environment	T_{amb}	0	—	50°	C	—
Storage temperature	T_{sto}	-10	—	60°	C	—
Humidity	H_{rel}	10	—	90	% r.h.	Free from condensation
Degree of protection	—	—	—	IP40	—	—

4.3.2 Mechanical Performance Data

Type	Max. vacuum	Suction rate	Sound level	Weight	Load limit Horizontal installation ¹	Load limit Vertical installation ² (l = 100 mm)
	%	l/min	dBa	kg	N	N
ECBP 24V-DC M12-8	75	0 - 12	57	0.75	Max. 100	Max. 25
ECBP 24V-DC TB-8	75	0 - 12	57	0.75	Max. 100	Max. 25

Note on the ECBPi load limits

These figures apply for static loads. The maximum load limits given here apply to the ECBPi only. For use in connection with an HRC-capable robot, observe the maximum weight limits determined by the manufacturer of the robot.

¹ horizontal installation

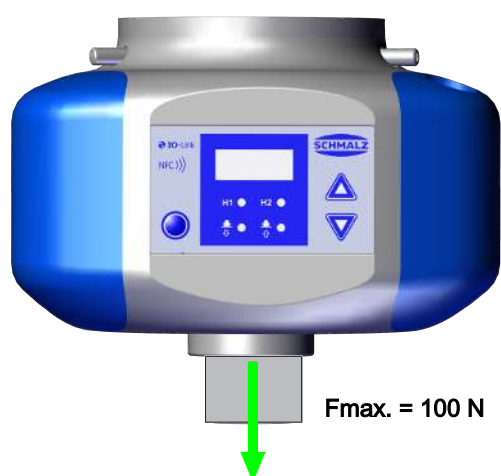

² vertical installation



4.3.3 Dimensions

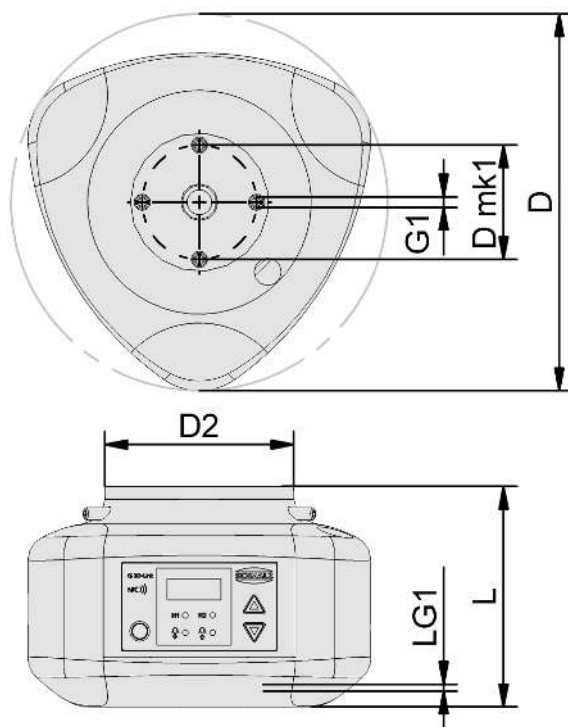

D	D2	L	Dmk1	G1	LG1
151.5	76	88.6	46	M4-IG	6



All dimensions given in millimeters [mm]

4.3.4 Maximum Torque

Connection	Max. torque
Thread G1	1.3 Nm
Attachment (3 set screws M5x16)	0.6 Nm

5 Operating and Menu Design

The CobotPump is operated using three buttons on the foil keypad.

	MENU BUTTON
	UP BUTTON
	DOWN BUTTON

Settings are configured in software menus. The following menus are available:

- Main menu: for standard applications
- Configuration menu: for applications with special requirements
- System menu: for reading out system data such as counters, the software version, etc.



After a parameter is set in the operating menu, the power supply of the switch must remain stable for at least 3 seconds. Otherwise, there may be a loss of data and the resulting error $E01$.

When no menu is open, the CobotPump is in display mode and the current vacuum level is shown.

The CobotPump reports overpressure in the vacuum circuit by displaying $[-FF]$.

A vacuum value outside of the measurement range is indicated by displaying $[FFF]$.

While settings are being changed, the system may enter an undefined state briefly (for approx. 50 ms).



5.1 Button Assignments in Display Mode

In display mode, a specific function is assigned to each key.



After about three seconds, the screen returns to the vacuum display.

5.1.1 Opening the Menu

Press the **MENU BUTTON** to open the menus as follows:

- ▶ Press the  button briefly.
 - ⇒ The main menu opens with the first parameter $[H-]$ or $[SPE]$.
- ▶ Press the  for about three seconds.
 - ⇒ The display flashes $[-c-]$
 - ⇒ The configuration menu opens with the first parameter $[cEr]$.

Starting the system menu:

- ▶ Press  and  simultaneously for about three seconds.
 - ⇒ The display flashes $[-S-]$
 - ⇒ The system menu opens with the first parameter $[cc l]$.

5.1.2 Display Supply Voltages and Temperatures

▶ Press the  button to display the following information in series:

- ⇒ [US]
- ⇒ (current power supply voltage for sensor in volts)
- ⇒ [UA]
- ⇒ (current power supply voltage for actuator in volts)
- ⇒ [EEC]
- ⇒ (current internal temperature in degrees Celsius)



The CobotPump is not a calibrated measuring device. However, the values may be used as a reference and for comparison measurements.

5.1.3 Display Operating Mode

▶ Press the  button to show the current operating mode: Standard/SIO mode or IO-Link mode:

- ⇒ [S IO] is displayed; the CobotPump is currently in SIO operating mode
- ⇒ [IO L] is displayed; the CobotPump is currently in IO-Link operating mode

5.2 Main Menu







All settings for standard applications can be accessed and configured using the main menu.

5.2.1 Functions in the Main Menu

The following table shows an overview of the display codes and parameters in the main menu:

Display code	Parameter	Explanation
H-1	Limit value H1	Deactivation value of control function (only if [cEr] = [On] is active)
SPE	Power	Indicates the percentage of the max. pump capacity (only if [cEr] = [OFF] is active and configurable)
H-2	Limit value H2	Switching value of "Parts control" signal output (when NO output is configured)
h-2	Hysteresis value h-2	Hysteresis value for "Parts control" signal output
EBL	Ventilation time	Ventilation time setting for time-controlled blowoff (only if [bLo] = [1-E] or [E-E] is active)
eAL	Zero-point adjustment (calibration)	Calibrate vacuum sensor, zero point = ambient pressure



5.2.2 Changing the Parameters of the Main menu

1. Press the  button briefly.
2. If the menu is locked: Enter a valid PIN code.
3. Use the  or  button to select the desired parameter.
4. Confirm using the  button.
5. Use the  or  button to change the value.

6. To save the new value, press and hold the  button for at least two seconds.
- ⇒ The displayed value flashes to confirm.
 - ⇒ The display automatically jumps to the next setting value.



Tips and Tricks for Parameter Setting

- By pressing the  or  button for approx. 3 seconds, the value to be changed is scrolled through quickly
- If you exit the changed value by briefly pressing , the value will not be applied.

5.3 Configuration Menu

The configuration menu is available for applications with special requirements.

5.3.1 Functions in the Configuration Menu









The following table shows an overview of the display codes and parameters in the configuration menu:

Display code	Parameter	Possible settings	Explanation
cEr	Energy-saving function	oN oFF	Control active Control function off (set the power via [SPE] in the main menu)
E-1	Max. evacuation time	configurable between 0.01 and 9.99 seconds in steps of 0.01 oFF	Switching value for parts control, evaluation in IO-Link only No monitoring
-L-	Leakage	Values configurable between 0 and 999	The adjustable leakage value can be used to judge the quality of the suction process. Evaluation in IO-Link only. Unit: Millibar per second
bLo	Blow off function	-E- I-E E-E	Externally controlled via IN ₂ (external signal) Internally controlled (triggered internally, time can be set) Externally controlled (triggered externally, time can be set)
SSe	Soft Start	oFF oN	No soft start The starting current is limited to approx. 600 mA
o-2	Signal output 2	no nc	Configure output 2, parts control for normally open for normally closed
o-3	Signal output 3	no nc	Configure output 3, condition monitoring for normally open for normally closed
EYI	Signal type of inputs	PnP nPN	Define signal type of inputs Signal type PNP, input on = 24V Signal type NPN, input on = 0V
EYo	Signal type of outputs	PnP nPN	Define signal type of outputs Signal type PNP, output on = 24V Signal type NPN, output on = 0V
uNI	Vacuum unit	-bA	Define the displayed vacuum unit Vacuum in mbar

Display code	Parameter	Possible settings	Explanation
		PS - iH - PA	Vacuum in psi Vacuum in inHg Vacuum in kPa
dLY	H2 switch-off delay	Values: 10, 50, 200 and OFF	Switch-off delay of the H2 signal Unit: milliseconds
dPY	Display rotation	Std rEd	Display configuration Standard rotated 180°
ECO	Display in ECO mode	OFF Lo on	Configure the display ECO mode is deactivated – the display remains on The brightness is reduced by 50 percent. Eco mode activated – if no buttons are pressed, the display turns off after one minute A dot appears in the lower left of the display to indicate that the device is still on.
Pin	PIN code	Value from 001 to 999	Specify the PIN code, lock the menus If the PIN code is 000, then the device is not locked.
rES	Reset	YES	All parameter values are reset to factory settings.



The factory settings of the parameters can be found in the appendix.

5.3.2 Changing the Parameters of the Configuration Menu

1. Press the  button for at least three seconds.
⇒ Meanwhile the display flashes [- C -].
2. If the menu is locked: Enter a valid PIN code.
3. Use the  or  button to select the desired parameter.
4. Confirm using the  button.
5. Use the  or  button to change the value.
6. To save the new value, press and hold the  button for at least two seconds.
7. To exit the configuration menu, press the  button for at least two seconds.



Tips and Tricks for Parameter Setting

- By pressing the  or  button for approx. 3 seconds, the value to be changed is scrolled through quickly
- If you exit the changed value by briefly pressing , the value will not be applied.

5.4 System Menu







The system menu can be used to read out system data, such as counters, the software version, the part and serial numbers, etc.

5.4.1 Functions in the System Menu

The following table shows an overview of the display codes and parameters in the system menu:

Display code	Parameter	Explanation
CC 1	Counter 1	Counter for suction cycles (suction signal input)
CC 2	Counter 2	Shows the operating time of the pump in hours
SO C	Software	Displays the current software version
Part	Part number	The part number is displayed
SN	Serial number	The serial number is displayed

5.4.2 Viewing Data in the System Menu

- ▶ Press and hold the  and  buttons simultaneously for at least three seconds.
 - ⇒ Meanwhile the display flashes [-5-].
- 1. If the menu is locked: Enter a valid PIN code.
- 2. Use the  or  button to select the parameter to be shown.
- 3. Confirm using the  button.
 - ⇒ The value is displayed.
- 4. To exit the system menu, press the  button for at least two seconds.

6 Description of Functions

6.1 Overview of Functions

Description	Availability		Parameter	See section
	SIO	IO-Link		
Operating modes	✓	✓	—	(> See <i>ch. Operating Modes, Page 25</i>) Automatic mode and Manual mode
Switching point setting	✓	✓	H1 SPE H-2 h-2	(> See <i>ch. Monitoring the System Vacuum and Defining Limit Values, Page 26</i>)
Calibrate zero position	✓	✓	cAL	(> See <i>ch. Calibrating the Vacuum Sensor, Page 27</i>)
Define venting time	✓	✓	tBL	(> See <i>ch. Blowoff Modes, Page 29</i>)
Energy-saving function, control function	✓	✓	cEr	(> See <i>ch. Control Function, Page 27</i>)
Blow off function	✓	✓	bLo	(> See <i>ch. Blowoff Modes, Page 29</i>)
Soft start	✓	✓	SSt	(> See <i>ch. Soft Start, Page 29</i>)
Configure signal inputs and outputs	✓	✓	o-2 o-3	(> See <i>ch. Output and Input Functions, Page 30</i>)
Transistor function, define signal type of inputs and outputs	✓	✓	tY1 tY0	(> See <i>ch. Signal Type, Page 30</i>)
Display unit	✓	✓	un1	(> See <i>ch. Select Vacuum Unit, Page 30</i>)
Switch-off delay	✓	✓	dLY	(> See <i>ch. Switch-off Delay, Page 31</i>)
Display alignment	✓	✓	dPY	(> See <i>ch. Rotating the Display, Page 31</i>)
Eco mode	✓	✓	Eco	(> See <i>ch. ECO Mode, Page 31</i>)
PIN code, access authorizations	✓	✓	PIn	(> See <i>ch. Locking and Unlocking the Menus, Page 32</i>)
IO-Link device access locks	✗	✓	—	(> See <i>ch. Locking and Unlocking the Menus, Page 32</i>)
Reset to factory settings	✓	✓	rES	(> See <i>ch. Resetting to Factory Settings (Clear All), Page 33</i>)
Counter(s)	✓	✓	cc1 cc2	(> See <i>ch. Counter(s), Page 34</i>)
Software version	✓	✓	SoC	(> See <i>ch. Displaying the Software Version, Page 34</i>)
Part number	✓	✓	ArE	(> See <i>ch. Displaying the Part Number, Page 35</i>)
Serial number	✓	✓	Snr	(> See <i>ch. Displaying the Serial Number, Page 35</i>)
Warnings and errors	✓	✓	e.g. E02	(> See <i>ch. Error Display, Page 35</i>) and (> See <i>ch. Troubleshooting, Page 53</i>)

			FFF -FF	
Temperature measurement	✓	✓	EEc	(> See ch. Temperature Display, Page 35)
Voltage measurement	✓	✓	US UR	(> See ch. Monitoring of the Supply Voltages, Page 36)
Condition monitoring (CM) Energy monitoring (EM) Predictive maintenance (PM)	✗	✓	E- I -L-	(> See ch. Energy and Process Control (EPC), Page 36)
Production setup profiles	✗	✓	—	(> See ch. Production Setup Profiles, Page 40)
IO-Link identification data	✗	✓	—	(> See ch. Device Data, Page 41)
User-specific identification	✗	✓	—	(> See ch. User-Specific Localization, Page 41)

6.2 Operating Modes

6.2.1 Automatic Operation

Once the CobotPump is connected to the power supply, it is ready for operation and enters automatic operation mode. This is the normal operating mode, in which the CobotPump is operated by the system controller.

The operating mode may be changed from automatic to manual mode using the buttons.

Parameterization of the CobotPump is always performed in automatic mode.

6.2.2 Manual Mode



NOTE

Change the output signals in manual mode

Personal injury or damage to property

- ▶ Electrical connection may be performed only by specialists who can judge the effects of signal changes on the overall system.

The CobotPump has a "Manual operation" mode. In manual mode, the "Suction" and "Blowoff" functions can be controlled independently of the higher-level controller using the buttons on the foil keypad of the operating element. In this operating mode, the "H1" and "H2" LEDs both flash.

Activating Manual Mode





NOTE

Manual mode modified by external signals

Personal injury or damage to property due to unpredictable work steps

- ▶ Ensure that the danger zone of the system is clear of people during operation.

- ▶ Press and hold the  and  buttons simultaneously for at least three seconds.
- ⇒ Meanwhile, the display shows [-1-].
- ⇒ The "H1" and "H2" LEDs flash.

Manual mode can be used even if the actuator supply voltage is off (emergency stop, setup mode).

Deactivating Manual Mode

- ▶ Press the  button.

The device also exits manual mode when the status of the external signal inputs changes.

When the CobotPump receives an external signal, it switches to automatic mode.

Activating and Deactivating Manual Suction

1. Press the  button to activate "Suction" mode.
2. Press the  button again or press the  button to deactivate "Suction" mode once more.

When the controller is on [C] = [M] it uses the configured limit values in "Manual" mode as well.

Activating Manual Blowoff

- ▶ Press and hold the  button.

6.3 Monitoring the System Vacuum and Defining Limit Values

The CobotPump has an integrated vacuum sensor for monitoring the current system vacuum. The current vacuum level is shown on the display and can be read out via IO-Link. The vacuum level provides information on the process and has an effect on the following LEDs, signals and parameters:

Parameter	Display	In IO-Link
Current vacuum level	✓	✓
Limit value LED H1	✓	✓
Limit value LED H2	✓	✓
Signal output H2	✓	✓
Process data bits H1	✗	✓
Process data bits H2	✗	✓

The limit values and hysteresis can be adjusted in the items [H-1], [H-2] and [h-2] of the main menu as well as via IO-Link.

The limit values are used by the controller function to control the pump cycle speed.

The data in the process data log is read out in IO-Link mode.

Overview of the vacuum limit values.

Limit value	Description
H1	Control value
H1 – 10%	Lower control value
H2	Activation value of "Parts control" ¹⁾ signal output
h2	Hysteresis of "Parts control" signal output
H2-h2	Deactivation value of "Parts control" ¹⁾ signal output

¹⁾ display when output is configured [NO]

6.4 Calibrating the Vacuum Sensor







Since the production conditions for the integrated vacuum sensor can vary, we recommend calibrating the sensor once it is installed. To calibrate the vacuum sensor, the system's vacuum circuit must be open to the atmosphere.

A zero offset is only possible in the range of ± 3 percent of the end value of the measuring range.

When the permissible limit is exceeded by ± 3 percent, error code $E03$ will appear in the display and on the IO-Link.

The function for zero-point adjustment of the sensor is called from the parameter cAL of the main menu or using the IO-Link.

Calibrating from the main menu:

1. If the menu is locked: Enter a valid PIN code.
 2. To set the zero point of the integrated sensor, press the  button.
 3. Press the  or  button until cAL appears in the display
 4. Confirm using the  button.
 5. Use the  or  button to select the configuration parameter [YES] and press the  button for at least two seconds.
- ⇒ The vacuum sensor is calibrated.

6.5 Control Function

This function of the CobotPump allows you to save energy or prevent generation of excessive vacuum levels. It also minimizes noise emissions. The limit values H1 and H1-10% are used by the controller function to control the rotation speed of the motor.

When the configured limit value H1 is reached, vacuum generation is interrupted and leakage measurements are performed. When leakage causes the vacuum level to fall below the limit value H1-10%, then the vacuum generator starts once more, working toward the value H1.

The control function is activated in the configuration menu using $[cEr] = [0r]$ and deactivated using $[cEr] = [0FF]$.

The following diagram illustrates how the controller functions.

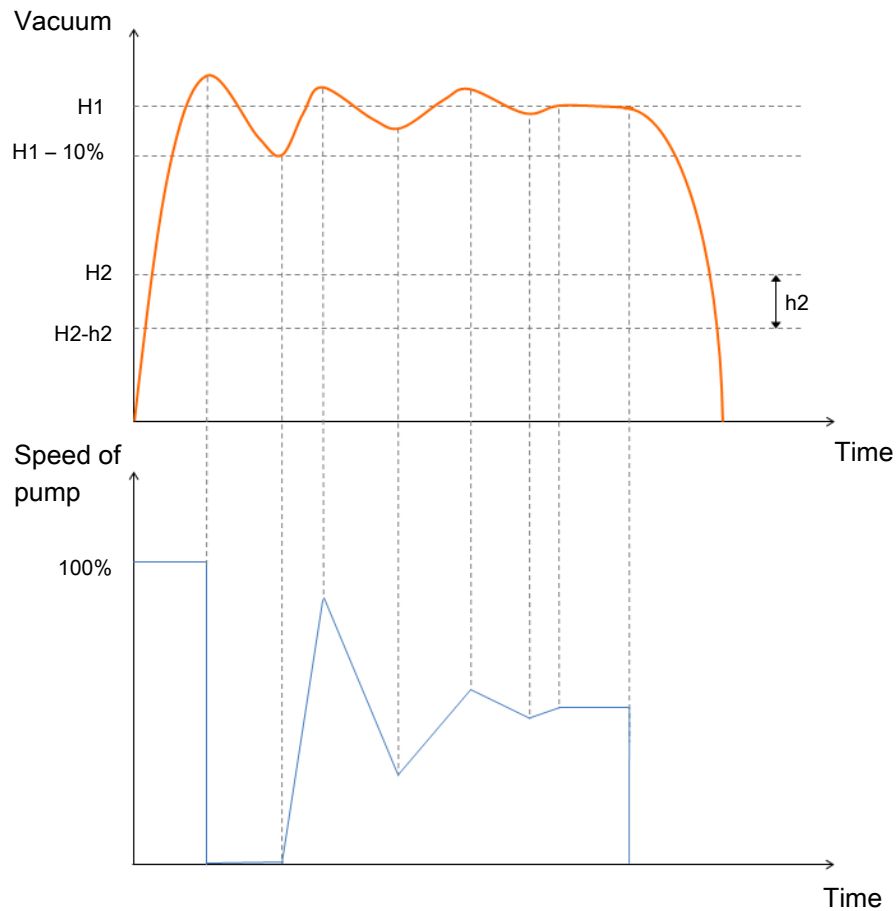

The output OUT2 (parts control) is set to "on" when the limit value H2 is reached. If the limit value H2-h2 is underrun, then the output is set to "off."

The following operating modes can be set for the controller function in the configuration menu under the [CTRL] menu item or via IO-Link.

6.5.1 Sustained Suction

The CobotPump sustains suction at the set power or motor rotation speed. In this mode, the control function is set to [CTRL] = [OFF].

The power of the pump can be adjusted via the process data in IO-Link mode or via the parameter [SPE] in SIO mode. Enter a value in the range from 0 to 255. If a value greater than 100 is entered, then the CobotPump runs at full power. If the value 50 is entered, then the CobotPump runs at half power.

If the value "0" is entered for the process data in IO-Link mode, then the value set for the parameter [SPE] in the main menu is used for the motor rotation speed.

6.5.2 Control

When the CobotPump has reached the limit value H1, it switches vacuum generation off. When the limit value H1-10% is underrun, then it switches back on, regulating the power to work toward the value H1.

In this mode, the control function is set to [CTRL] = [ON].

This setting is recommended for all workpieces, in particular those that permit airtight suction.

6.6 Blowoff Modes

The following three blowoff modes are available. The function can be set with the parameter [bL□] in the configuration menu or via IO-Link.

6.6.1 Externally Controlled Blowoff

The "Blowoff" valve is controlled directly via the "Blowoff" signal input IN₂. The CobotPump vents to atmosphere as long as the signal is present.

In this mode, the blowoff function is set to [-E-].

6.6.2 Internally Time-controlled Blowoff

In this mode, the blowoff function is set to [I-E].

The "Blowoff" valve is automatically activated for the time period set as soon as the device leaves "Suction" mode. This function makes it possible to save an output on the controller. The blowoff time can be set with the parameter [tBL] in the main menu. The parameter [tBL] is suppressed in the main menu if the operating mode [-E-] is active.

The "Blowoff" signal overrides the "Suction" signal, even if the specified blowoff time is very long.



"Blowoff" mode can still be activated in [I-E] mode using the "Blowoff" signal input.

6.6.3 Externally Time-controlled Blowoff

In this mode, the blowoff function is set to [E-E].

The blowoff pulse is controlled externally via the "Blowoff" input IN₂. The "Blowoff" valve is activated for the specified time [tBL]. A longer input signal does not increase the duration of blowoff.

The blowoff time can be set with the parameter [tBL] in the main menu. The parameter [tBL] is suppressed in the main menu if the operating mode [-E-] is active.

6.6.4 Setting the Blowoff Time

If the blowoff function of the CobotPump is set to internally time-controlled [bL□] = [I-E] or externally time-controlled [bL□] = [E-E] "auto-venting", then the blowoff time [tBL] may be specified.

The displayed value indicates the blowoff time in seconds. The blowoff time can range from 0.10 to 9.99 seconds.

The parameter [tBL] is suppressed in the basic menu if the operating mode [-E-] is active.

6.7 Soft Start

The CobotPump is equipped with a soft start feature to prevent current pulses of more than 600 mA. This feature reduces the power of the CobotPump to about 30 percent while starting and then increases the power to 90 percent within approx. 400 ms.

The soft start feature is defined using the parameter [SSt] in the configuration menu or via IO-Link.

6.8 Output and Input Functions

6.8.1 Signal Outputs

The CobotPump is equipped with two signal outputs, OUT₂ and OUT₃. The function of the limit value H2 / h2 (parts control) is assigned to signal output OUT₂, while the condition monitoring communication function is assigned to signal output OUT₃.

The signal outputs can be switched between "normally open" (NO) and "normally closed" (NC) operation in the configuration menu. Configuration may be performed using the corresponding parameters [O-2] and [O-3] or via IO-Link.

By default, the outputs are set to [NC], meaning that the function is triggered when a signal is received.

The switching point [H-2] of the output OUT₂ and hysteresis [H-3] may be configured from the main menu.

6.8.2 Signal Inputs

The CobotPump is equipped with two signal inputs, IN₁ and IN₂. The "Suction" function is assigned to signal input IN₁, while the "Blowoff/Vent" function is assigned to signal input IN₂.

By default, the signal inputs are set to [NC], meaning that the function is triggered when a signal is received.

6.8.3 Signal Type

The signal type can be used to switch between PNP and NPN. The change can be made using the corresponding parameters in the configuration menu or via IO-Link.

The signal type for the inputs may be configured with the parameter [I-1].

The signal type for the outputs may be configured with the parameter [I-2].

6.9 Select Vacuum Unit

The unit of the displayed vacuum level can be set using this function.

The function can be configured with the parameter [U-1] in the configuration menu or via IO-Link.

The following units are available:

Unit	Explanation
bar	The vacuum level is displayed in mbar. The setting for this unit is [BA].
Pascal	The vacuum level is displayed in kPa. The setting for this unit is [PA].
Inch of Hg	The vacuum level is displayed in inHg. The setting for this unit is [IH].
psi	The vacuum level is displayed in psi. The setting for this unit is [PS].



Selection of the vacuum unit only affects the display of the CobotPump. The units of the parameters that can be accessed via IO-Link are not affected by this setting.

6.10 Switch-off Delay

You can use this function to set a switch-off delay for the H2 component check signal. This can be used to mask short-term fluctuations in the vacuum level of the vacuum system. The duration of the switch-off delay can be set with the parameter [dL4] in the configuration menu or via IO-Link. Selectable values are 10, 50 and 200 ms. To deactivate this function, enter the value [000] (= off).

The switch-off delay affects the OUT₂ discrete output, the process data bit in IO-Link and the H2 status display

-  If the OUT₂ output is configured as a normally open contact [no], there will be an electrical switch-off delay. On the other hand, if it is configured as a normally closed contact [nc], there will be an equivalent switch-on delay.

6.11 Rotating the Display

To allow different installation positions, the orientation of the display can be rotated by 180° by changing the parameter [dP4] in the configuration menu or via IO-Link.

The factory setting is [5E d]. This corresponds to the standard configuration.

To rotate the display by 180°, select the parameter setting [r0E].

-  With the display rotated, the  and  buttons switch functions. The Down button becomes the Up button.

The decimal points of the display are shown on the top edge of the screen.

When the display is rotated, the decimal point on the far right is no longer displayed and is therefore missing from the display of the counters and serial numbers.

6.12 ECO Mode

The CobotPump offers the option to switch off the display or to dim the display to save energy. If ECO mode is activated, the display is switched off to reduce power consumption after 1 minute if no buttons are pressed.

ECO mode can be enabled and disabled with the parameter [E00] in the configuration menu or via IO-Link.

Three different settings are available:

- [0FF]: Energy-saving mode is disabled.
- [L0]: The brightness of the display is reduced by 50 percent.
- [00]: The display switches off after one minute of inactivity.

A red dot in the lower right corner of the display indicates that the display has been switched off.

The display is reactivated by pressing any button or by an error message.

-  If you activate ECO mode using IO-Link, the display will immediately enter energy-saving mode.

6.13 Locking and Unlocking the Menus

The menus can be protected from unwanted access by means of a PIN code [P 17] or in the IO-Link using Device Access Locks. The PIN is set to 000 on delivery. The menus are not protected.











A PIN is recommended because carrying out parameterization while the device is in operation can change the status of signal inputs and outputs.

6.13.1 PIN Code

To enable the lock, a valid PIN code between 001 and 999 must be entered in parameter [P 17] in the configuration menu or via IO-Link.

The following describes how to set a PIN Code using the operating and display element.

1. Press the  button for at least three seconds.
 - ⇒ Meanwhile the display flashes [- □ -].
 - ⇒ The configuration menu opens.
2. Use the  or  button to select the menu item [P 17].
3. Confirm using the  button.
4. Use the  or  button to enter the first digit of the PIN code
5. Confirm by pressing the  button briefly to move to the next digit.
6. Enter the remaining digits in the same way.
7. To save the new PIN Code, press and hold the  button for at least two seconds.
 - ⇒ The display flashes [L □ □] and the configuration menu closes.
 - ⇒ The menus are now locked.

The PIN code "000" must be set for permanent deactivation of the lock.

Full access to the device is still possible via IO-Link even if a PIN is enabled. The current PIN can also be read out and changed/deleted (PIN = 000) via IO-Link.

6.13.2 Restricting Access Using Device Access Locks

In IO-Link mode, the "Device Access Locks" default parameter is available to prevent changes to parameter values using the operating element of the CobotPump.

Bit	Meaning
2	Local parametrization locked (Parameters cannot be changed via the user menu)

A menu lock using the Device access locks parameter has a higher priority than the menu PIN. In other words, this lock cannot be bypassed by entering a PIN and remains in SIO mode.

It can only be canceled using IO-Link, not on the CobotPump itself.

6.13.3 Unlocking the Menus

Menus can be protected against unauthorized access by defining a PIN code [P 17] in the configuration menu. When the lock is active, [L □ □] flashes in the display or the PIN code is requested.

**Tips and Tricks for Parameter Setting**

- By pressing the or button for approx. 3 seconds, the value to be changed is scrolled through quickly
- If you exit the changed value by briefly pressing , the value will not be applied.

The menus can be unlocked as follows:

1. Press the button.
2. Use the or button to enter the first digit of the PIN code
3. Confirm using the button.
4. Enter the remaining digits in the same way.
5. Press the button to unlock the menu.
 - ⇒ When a valid PIN is entered, the message [L OK] is displayed.
 - ⇒ When an invalid PIN is entered, the message [L □ □] is displayed and the menus remain locked.

The lock is automatically activated once more when the selected menu is closed or the desired function has been completed. The PIN code 000 must be set for permanent deactivation of the lock.

The PIN is set to 000 on delivery. The menus are not protected.



If the correct PIN code has been lost, then the CobotPump must be sent back to the manufacturer for unlocking.

6.14 Resetting to Factory Settings (Clear All)

This function restores the configuration of the CobotPump, the initial setup, and the settings of the active production setup profile to the factory defaults.

This function is executed using the parameter [r E 5] in the configuration menu or via IO-Link.

The factory settings of the CobotPump can be found in the appendix.

**WARNING**



By activating/deactivating the product, output signals lead to an action in the production process!

Personal injury

- ▶ Avoid possible danger zone.
- ▶ Remain vigilant.

A description of how to reset the CobotPump to factory settings using the display and operating element follows:

1. Press the button for at least three seconds.
2. If the menu is locked: Enter a valid PIN code.
3. Use the or button to select the parameter [r E 5].
4. Confirm using the button.

5. Use the  or  button to select the configuration parameter [4E5] and press the button for at least three seconds.
 - ⇒ The CobotPump is reset to the factory settings.
 - ⇒ The display flashes briefly and then returns to the display mode.

The reset to factory settings function does not affect the following:

- Counter readings
- The zero-point adjustment of the sensor
- The IO-Link parameter "Application specific tag"

6.15 Counter(s)

The CobotPump is equipped with two internal counters that cannot be cleared.

Counter 1 [CC 1] increments with each valid pulse at the "Suction" signal input, meaning that it counts all the suction cycles during the CobotPump's service life.



Counter 2 [CC 2] measures the total running time of the CobotPump in seconds.

Display code	Function	Description
CC 1	Counter 1	Counter for suction cycles (suction signal input)
CC 2	Counter 2	Running time of the CobotPump in seconds

The counters can be displayed or read out using the parameters [CC 1] and [CC 2] in the system menu or via IO-Link.

Displaying a counter on the operating panel of the CobotPump:

- ✓ Select the desired parameter in the system menu.
- ▶ Confirm the parameter by pressing the  button.
 - ⇒ The last three decimal places of the counter total are displayed. The decimal point at the far right flashes. This corresponds to the least significant three digits.

Use the  and  buttons to display the remaining decimal places of the counter total. The decimal points show which three-digit block of the counter total is shown in the display.

The counter total is comprised of the three digit blocks together as follows:



Displayed section	10 ⁶	10 ³	10 ⁰
Digit block	0.48	6 18	593.

The current counter total in this example is 48 618 593.

- ▶ To exit the function, press the  button.

6.16 Displaying the Software Version



The software version indicates the software currently running on the internal controller.

1. If the menu is locked: Enter a valid PIN code.
2. Use the  or  button to select the parameter [50C].
3. Confirm using the  button.
 - ⇒ The value is displayed.

- ▶ To exit the function, press the  button.

6.17 Displaying the Part Number

The part number is both printed on the CobotPump's label and stored electronically.

After confirming the part number [Pn] parameter with the  button, the first two digits of the part number are displayed. The remaining digits of the part number are displayed with the  button. The displayed decimal points are part of the part number.

The part number consists of 4 number blocks with a total of 11 digits.



Displayed section	1	2	3	4
Digit block	10.	020	200	383

The part number in this example is 10.02.02.00383.

- ▶ To exit the function, press the  button.

6.18 Displaying the Serial Number

The serial number indicates the production period of the CobotPump. After confirming the serial number parameter [Sn] with the  button, the first three decimal places of the serial number are displayed (the digits $\times 10^0$). The decimal point at the far right flashes. This corresponds to the least significant three digits.

Use the  and  buttons to display the remaining decimal places of the serial number. The decimal points show which three-digit block of the serial number is shown in the display.

The serial number as a whole is comprised of the three digit blocks together as follows:

Displayed section	10^6	10^3	10^0
Digit block	0.48	6 18	593.

The current serial number in this example is 48 618 593.

- ▶ To exit the function, press the  button.

6.19 Error Display

If an error occurs, it appears on the display in the form of an error code ("E number"). The CobotPump's behavior in response to an error depends on the type of error.

For a list of possible errors and the corresponding codes for the SIO and IO-Link operating modes, consult chapter (> See *ch. Troubleshooting, Page 53*).

Any operation being performed in the menu will be interrupted if an error occurs. The error code can also be opened as a parameter using IO-Link.

6.20 Temperature Display

The temperature is monitored in the area of the circuit board. If the temperature exceeds an internal limit value, the CobotPump switches off to protect against overheating.

6.21 Monitoring of the Supply Voltages

The CobotPump has an internal voltage monitor. It requires a power supply of 24 V. If the voltage deviates outside a certain tolerance range, the CobotPump enters an error state.

The error state is shown on the display and/or reported on IO-Link.

The table below shows the possible error messages and explains their meaning.

Error code displayed	Meaning
E 05	Actuator supply voltage U_A too low or not present
E 07	Sensor supply voltage U_S too low
E 15	Actuator supply voltage U_A too high
E 17	Sensor supply voltage U_S too low

Use of the menu and reaction to input signals is disabled. The "parts check" output retains its normal functionality.

The current supply voltage can still be viewed using the  button.

Vacuum generation is switched off if the supply voltage deviates.

6.22 Energy and Process Control (EPC)

In IO-Link mode, the energy and process control (EPC) function is available. It is subdivided into three modules:

- Condition monitoring (CM): Condition monitoring to increase system availability
- Energy monitoring (EM): Energy monitoring to optimize the vacuum system's energy consumption
- Predictive maintenance (PM): Predictive maintenance to increase the performance and quality of the gripping systems

6.22.1 Condition Monitoring (CM)

Control Threshold Monitoring

If the switching point H1 is never reached during the suction cycle, the "H1 not reached" condition monitoring warning is triggered and the system status light switches to yellow.

This warning is available at the end of the current suction phase and remains active until the next suction cycle.

Evacuation Time Monitoring

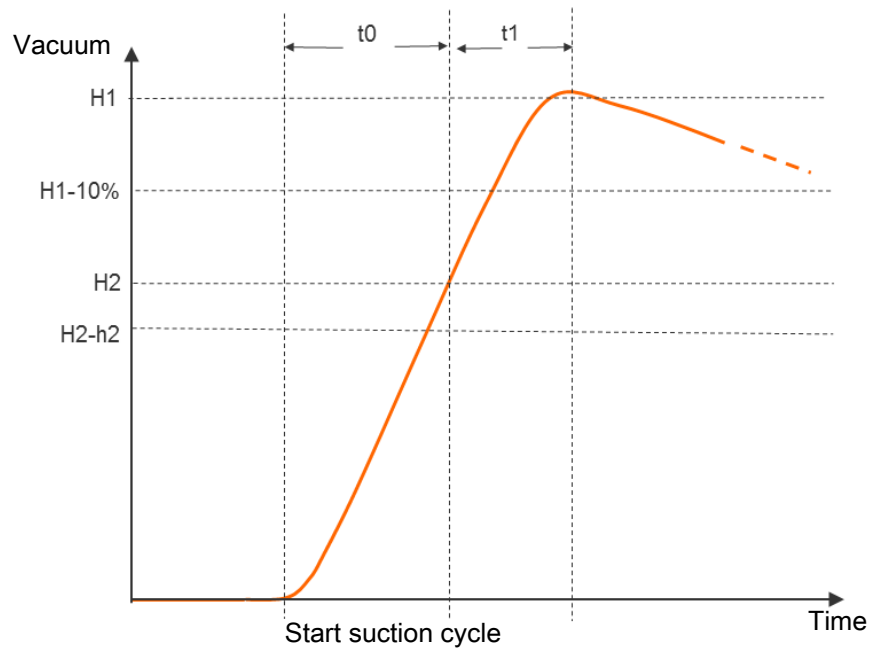

If the measured evacuation time t_1 (from H2 to H1) exceeds the specified value, the "Evacuation time longer than t_1 " condition monitoring warning is triggered and the system status light switches to yellow. The specified value for the max. permitted evacuation time can be set in the configuration menu with the parameter [E - l] or via IO-Link. Setting the value to [000] (= off) deactivates monitoring. The maximum permitted evacuation time setting is 9.99 s.

Measuring the Evacuation Time t_0 and t_1

Measuring the evacuation time t_0 :

The time is measured (in ms) from the beginning of the suction cycle to the time when the limit value H2 is reached.

Measuring the evacuation time t_1

The interval between reaching the limit values H2 and H1 is measured in milliseconds.

Leakage Monitoring and Evaluation

In control mode (ctr = on), the loss of vacuum within a certain period is monitored (mbar/s). The measured value "L" in mbar/s can be queried via IO-Link.

Evaluation of the leakage level differentiates between two states:

Leakage $L <$ permitted value $-L-$

If the leakage L is less than the set value $-L-$,

- then the vacuum continues dropping until the switching point $H1-h1$ is reached.
- The ejector begins to suck again (normal control mode).
- The condition monitoring warning is not activated
- The system status indicator light does not change

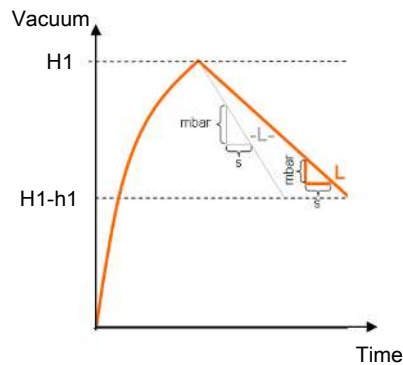

Leakage $L >$ permitted value $-L-$

If the leakage L is greater than the set value $-L-$,

- der Ejektor regelt sofort wieder nach
- The condition monitoring warning is activated
- The system status indicator light turns yellow

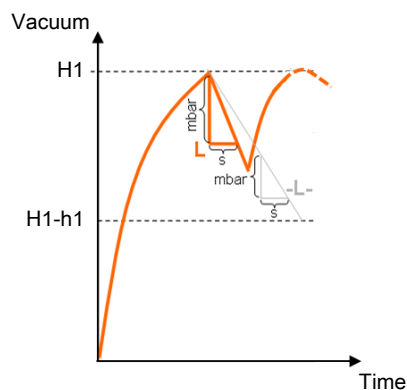

The permitted leakage value $-L-$ can be set in the configuration menu with the parameter $[-L-]$ or via IO-Link.

This function determines the average leakage during the last suction cycle, divides it into subareas and makes it available as a parameter via IO-Link.

Monitor Dynamic Pressure

If possible, a dynamic pressure measurement is taken at the start of every suction cycle (vacuum during unobstructed suction). The result of this measurement is compared to the limit values set for $H1$ and $H2$.

If the dynamic pressure is greater than $(H2 - h2)$ but less than $H1$, the corresponding condition monitoring warning is triggered and the status light switches to yellow.

Autoset

The CM Autoset IO-Link function allows the condition monitoring parameters for the maximum permitted leakage ($-L-$) and the evacuation time ($t-1$) to be determined automatically. The actual values from the last suction cycle are combined with additional tolerance and stored.

Condition Monitoring Events and Status Display

Any condition monitoring events that occur during the suction cycle cause the system status indicator light to immediately switch from green to yellow. The event that caused this switch can be seen in the "Condition monitoring" IO-Link parameter.

The table below explains the coding of the condition monitoring warnings:

Bit	Event	Update
0	Not used	Cyclic
1	Set limit value t-1 for evacuation time exceeded	Cyclic
2	Set leakage limit value -L- exceeded	Cyclic
3	Limit value H1 was not reached	Cyclic
4	Dynamic pressure > (H2 - h2) and < H1	As soon as a corresponding dynamic pressure value has been determined
5	Supply voltage U_s outside the operating range	Constant
6	Supply voltage U_A outside the operating range	Constant
7	Temperature over 50° C	Constant

Bits 0 to 3 describe events that can only occur once per suction cycle. They are reset at the start of every suction cycle and remain stable until it has ended.

Bit number 4, which describes dynamic overpressure, is initially deleted when the device is switched on and is updated when a dynamic pressure value is detected.

Bits 5 to 7 are regularly updated independently of the suction cycle and reflect the current values for the supply voltage and temperature.

The values measured by the condition monitoring, namely the evacuation times t_0 and t_1 and the leakage value L , are reset at the beginning of the suction and updated once they have been measured.

6.22.2 Energy Monitoring (EM)

In order to permit optimization of vacuum gripping systems' energy efficiency, the CobotPump provides a function for measuring and displaying the energy consumption. The electrical energy consumed by the device and by the valve coil (-n) during a suction cycle is measured and given in watt-seconds (Ws).

The measured value is reset at the beginning of the suction cycle and constantly updated during the running cycle. Thus no further change can occur after venting has finished. For determining the electrical energy consumption, the neutral phase of the suction cycle must also be considered. Therefore the measured values can be updated only when the next suction cycle begins. During the entire cycle, they represent the results from the previous cycle.



The CobotPump is not a calibrated measuring device. However, the values may be used as a reference and for comparison measurements.

6.22.3 Predictive Maintenance (PM)

Overview of Predictive Maintenance (PM)

In order to allow early detection of wear and other impairments to the vacuum gripping system, the CobotPump provides functions for recognizing trends in the quality and performance of the system. This is accomplished using the measured values for leakage and dynamic pressure.

The measurement value for the leakage rate and the related quality assessment in percent are reset at the start of every suction cycle and constantly updated during the cycle as moving averages. The values therefore remain stable until after the suction cycle is complete.

Measurement of Leakage

The control function interrupts suction as soon as it reaches the limit value H1. Then the leakage is measured as the vacuum decrease over time (in mbar/s).

Dynamic Pressure Measurement

This measures the system vacuum achieved during unobstructed suction. The measurement length is approx. 1 s. Thus evaluation of a valid dynamic pressure value requires at least one second of unobstructed suction after the suction cycle has commenced. The suction point must not be occupied by a component at this time.

Measured values below 5 mbar or above the limit value H1 are not regarded as valid dynamic pressure measurements and are discarded. The result of the last valid measurement is retained.

Measured values that are below the limit value H2 – h2 but simultaneously above the limit value H1 result in a condition monitoring event.

The dynamic pressure and the performance value in percent based on it are initially unknown when the CobotPump is switched on. As soon as a dynamic pressure measurement can be performed, the dynamic pressure and the performance evaluation are updated and retain their values until the next dynamic pressure measurement.

Quality Assessment

In order to evaluate the entire gripping system, the CobotPump calculates a quality rating based on the measured system leakage.

The greater the leakage in the system, the worse the quality rating of the gripping system. Conversely, low leakage results in a high quality rating.

Performance Calculation

The performance calculation helps in evaluating the system status. The performance of the gripping system can be assessed based on the measurement of the dynamic pressure.

Optimal configuration of gripping systems leads to low dynamic pressure and thus to high performance. Conversely, badly configured systems achieve low performance.

Dynamic pressure events that exceed the limit value (H2 – h2) always result in a performance rating of zero percent. A dynamic pressure value of 0 mbar (which indicates that no valid measurement value could be obtained) also results in a performance rating of zero percent.

6.23 Production Setup Profiles

In IO-Link mode, the CobotPump can store up to four different production setup profiles (P-0 to P-3). All important parameter data for workpiece handling is stored in these profiles. The profile is selected by means of the process data byte PDO byte 0. Thus parameters can be adjusted to suit differing process conditions.

The currently selected data set is displayed in the parameter data under "Production Setup". This data set corresponds to the current parameters the CobotPump is working with, which can be viewed using the menu.

Displaying the parameter data set (P-0 to P-3) currently in use during IO-Link operation:

- ▶ Select the main menu using the  button.
- ⇒ The parameter data set (P-0 to P-3) currently in use is briefly shown in the display.

In the default setting and in SIO mode, the P-0 production setup profile is selected.

6.24 Device Data

The CobotPump provides a range of identification data that can be used to uniquely identify a device.

The following parameters can be queried via IO-Link or NFC:

- Manufacturer's name and website
- Supplier text
- Product name and product text
- Serial number
- Version status of the hardware and firmware
- User ID
- Unique device ID and device characteristics
- Part number and development status
- Manufacture and installation date
- Location ID
- System Configuration
- Device ID
- Web link for NFC app device description file
- Storage ID

6.25 User-Specific Localization

The following parameters are available when saving application-specific information in any CobotPump.

- Identification of the installation location
- Identification of the storage location
- Equipment labeling from the circuit diagram
- Installation date
- Geo-location

The parameters are ASCII character strings with the maximum length given in the data dictionary. They can also be used for other purposes if necessary.

The NFC web link parameter is a special feature. This parameter must include a valid web address beginning with `http://` or `https://` and is automatically used as a web address for NFC read accesses. As a result, read accesses from smart phones or tablets are rerouted e.g. to an address in the company's own intranet or a local server.

7 Transport and storage

7.1 Checking the Delivery

The scope of delivery can be found in the order confirmation. The weights and dimensions are listed in the delivery notes.

1. Compare the entire delivery with the supplied delivery notes to make sure nothing is missing.
2. Damage caused by defective packaging or in transit must be reported immediately to the carrier and J. Schmalz.

8 Installation

8.1 Installation Instructions



CAUTION

Improper installation or maintenance

Personal injury or damage to property

- ▶ Prior to installation and before maintenance work, the vacuum generator must be disconnected from the power supply and secured against unauthorized restart!

For safe installation, the following instructions must be observed:

1. Use only the connections, mounting holes and attachment materials that have been provided.
2. Firmly connect and secure pneumatic and electrical line connections to the vacuum generator.

8.2 Mechanical Attachment

The CobotPump may be installed in any position.



The CobotPump can be attached to a collaborative robot using a replaceable flange adapter plate. The markings on the flange and on the housing of the CobotPump must be observed, as these determine the orientation of the display and the suction cup on the robot.

- ✓ The flange adapter plate is attached to the robot.

1. Push the CobotPump onto the flange adapter plate, observing the Poka Yoke markings.

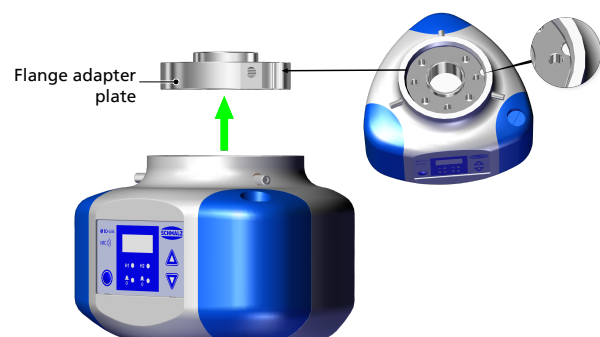

2. Attach the CobotPump using three radial set screws (M5x16) tightened to 0.6 Nm.

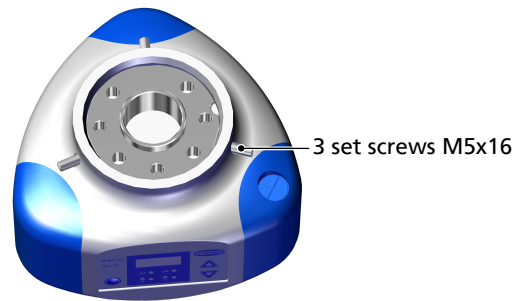

Vacuum end effectors or customer-specific grippers are attached to the CobotPump via the flange module (6).

8.3 Electrical Connection

8.3.1 Description of the Electrical Connection



NOTE

In addition to the rated current, current peaks of up to 2 A flow for a short time in the default setting.

For certain robots, the current consumption of the end effector is limited (e.g. robots from Universal Robots provide a maximum of 600 mA at the electrical flange connection.)

Damage to the robot due to current pulses!

- ▶ Refer to the technical description of the robot for the maximum current.
- ▶ The CobotPump may have to be changed to Soft Start $SS\bar{t}$ in the configuration menu to avoid current pulses above 600 mA.



CAUTION

Change of output signals when product is switched on or plug is connected

Personal injury or damage to property!

- ▶ Electrical connection may be performed only by a qualified specialist who can predict the effects that signal changes will have on the entire system.



NOTE

Incorrect power supply

Destruction of the integrated electronics

- ▶ Operate the product using a power supply unit with protected extra-low voltage (PELV).
- ▶ The system must incorporate safe electrical cut-off of the power supply in compliance with EN60204.
- ▶ Do not connect or disconnect the connector under tension and/or when voltage is applied.

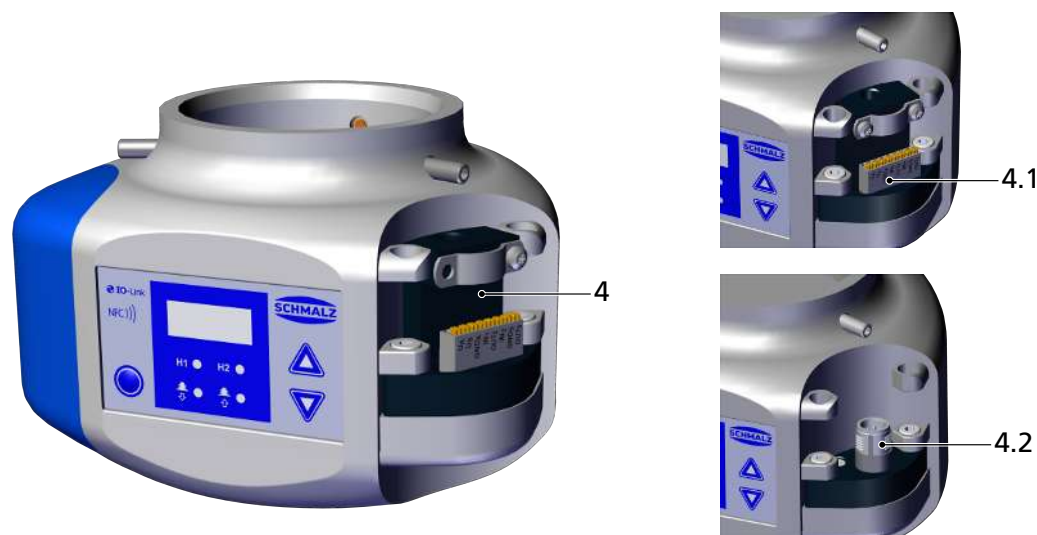

The CobotPump is electrically connected to the power supply and for input and output signaling purposes via the interface at item 4. The connection can be established using a flexible cable connection for device versions with a terminal block (4.1) or an 8-pole M12 connector (4.2).

The table below shows the pin assignment of the electrical connection options in the operating modes SIO and IO-Link:

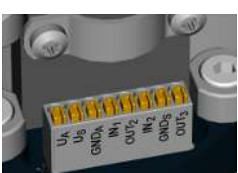
M12 connector / terminal block	Pin	Symbol	Function with SIO	Function with IO-Link
 ECBPi TB-8 	1	U_A	Power supply for actuator	
	2	U_S	Power supply for sensor	
	3	GND_A	Actuator ground	
	4	IN_1	"Suction" signal input	—
	5	OUT_2	"Parts control" signal output (H2)	IO-Link communication
	6	IN_2	"Blow off" signal input	—
	7	GND_S	Sensor ground	
	8	OUT_3	CM (Condition Monitoring)	—

The CobotPump has separate, electrically isolated power supplies for the actuator and the sensor.

The pump, valves and input signals "Suction" and "Blowoff" are supplied and switched via the actuator power supply.

The output signals are switched via the sensor power supply. Thus the input and output signals are electrically isolated from each other.

Mounting and removal may be performed only when the device is unpressurized and disconnected from the mains. Electrical connections must be firmly connected and secured to the CobotPump.

When connecting to the power supply, take note of the following:

- The maximum length of the connection cable in SIO operation mode is 30 meters.
- The maximum length of the connection cable in IO-Link operation mode is 20 mode.

A selection of suitable connection cables is listed in the section on Accessories (> See *ch. Accessories, Page 52*).

The CobotPump can be connected directly to the controller or via an I/O box.

8.3.2 Mounting the Connection Cable

Connecting the connection cable to the CobotPump:

1. Pull off the corresponding "bumper".



2. Pull the selected cable through the cable duct by the bumper.

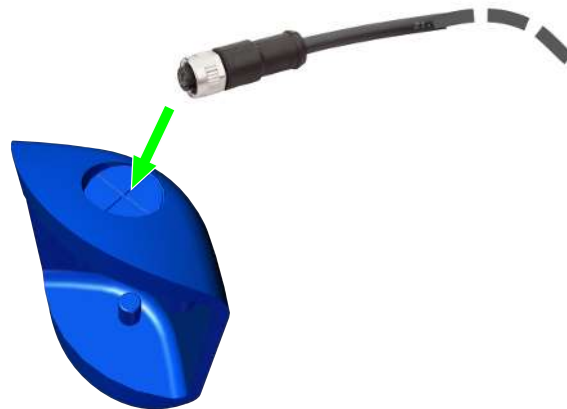

3. Connect the cable either by its loose strands to the appropriate positions on the terminal block (4.1) or by the M12 connector (4.2).

M12 connector



terminal block

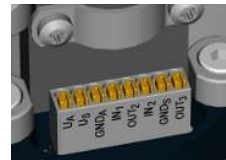

4. Attach the bumper to the CobotPump with the attachment tabs.

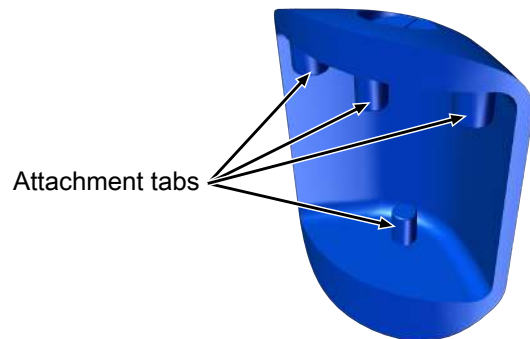

8.4 Start of Operations



NOTE

Incorrect signal type in the CobotPump standard with UR robots

CobotPump not communicating with the higher-level controller in SIO mode

- ▶ Switch the signal input to NPN (via the parameter [123 1] in the configuration menu of the CobotPump).



The vacuum of the CobotPump is routed to the vacuum gripping system via the flange module, item (6).

A typical handling cycle is divided into the following three phases: pickup, blowoff and idle.

To check whether sufficient vacuum has built up, an integrated vacuum sensor monitors the limit value H2 during suction.

Phase	Switching step	CobotPump		
		Signal	State	
1	1		IN1	Suction ON
	2		OUT2	Vacuum > H2
2	3		IN1	Suction OFF
	4		IN2	Blowoff ON
3	5		OUT2	Vacuum < (H2-h2)
	6		IN2	Blowoff OFF

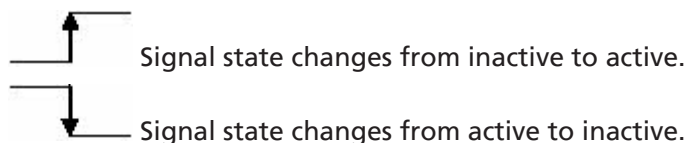

9 Operation

9.1 Preparations



⚠ WARNING

Extraction of hazardous media, liquids or bulk material

Personal injury or damage to property!

- ▶ Do not extract harmful media such as dust, oil mists, vapors, aerosols etc.
- ▶ Do not extract aggressive gases or media such as acids, acid fumes, bases, biocides, disinfectants or detergents.
- ▶ Do not extract liquids or bulk materials, e.g. granulates.

Before each activation of the CobotPump, the following measures must be taken:

1. Check the device for visible damage. Correct any faults or report them to the supervising personnel.
2. Ensure that only authorized persons are present in the working area of the machine or system in order to prevent any hazard from switching on the machine.
3. Ensure that the danger range of the machine or system is free of persons during automatic operation in non-HRC applications.

9.2 Operating Modes

The CobotPump may be operated in two modes:

- SIO mode, with direct connections at inputs and outputs (SIO = standard I/O)
- IO-Link mode, with a communications line (IO-Link)

By default, the CobotPump always runs in SIO mode, but it can be switched into and out of IO-Link mode at any time using an IO-Link master.

9.2.1 SIO Operating Mode

During operation in SIO mode, all input and output signals are connected to a controller, either directly or using intelligent terminal boxes.

For this purpose, in addition to the power supply lines, two input signals and two output signals must be connected. The CobotPump communicates with the controller via these signals.

This enables use of the basic functions "Suction" and "Blowoff" as well as the "Parts control" feedback.

The individual basic functions:

Inputs of the CobotPump	Outputs of the CobotPump
Suction ON/OFF (IN ₁)	H2 (Parts control) feedback (OUT ₂)
Blowoff ON/OFF (IN ₂)	Condition monitoring feedback (OUT ₃)

If the CobotPump is operated in the "internally time-controlled" blowoff mode, then the "Blowoff" signal is not required. This allows operation on a single port in a configurable terminal box (using 1xDO and 1xDI).

The parameters in the available menus can be configured and certain information read out using the operating and display element.

The following basic functions are available in SIO operating mode:

- Current vacuum level
- Error messages and warnings
- Status display of the system

- Access to all parameters
- Counter(s)

In SIO operating mode, the following functions are **not** available or are available to a limited extent via output OUT₃:

- Condition monitoring (CM)
- Energy monitoring (EM)
- Predictive maintenance (PM)

9.2.2 IO-Link Operating Mode

During operation in SIO (digital communication) mode, the power supply voltages and the communication line are connected to a controller, either directly or using intelligent terminal boxes. The CobotPump can be finely parameterized in IO-Link mode.

When the CobotPump is connected via IO-Link, the following functions are enabled in addition to the basic functions:

- Selection between four production setup profiles
- Error messages and warnings
- Status display of the system
- Access to all parameters
- Condition monitoring
- Energy monitoring
- Predictive maintenance

All modifiable parameters can be read, modified and written back to the CobotPump by the higher-level controller.

Evaluation of the condition monitoring and energy monitoring results affords direct feedback regarding the current handling cycle as well as trend analysis.

The CobotPump supports IO-Link version 1.1 with four bytes of input data and two bytes of output data.

The exchange of process data between the IO-Link master and the CobotPump is cyclical. Parameter data (acyclical data) is exchanged by the user program in the controller using communication modules.

10 Maintenance

10.1 Safety

Maintenance work may only be carried out by qualified personnel.



⚠ WARNING

Risk of injury due to incorrect maintenance or troubleshooting!

- ▶ Check the proper functioning of the product, especially the safety devices, after every maintenance or troubleshooting operation.

Opening the CobotPump will damage the "tested" labels. This voids the warranty.

10.2 Cleaning the Device

1. Remove exterior dirt with a soft cloth and soap suds (max. 60° C).
2. Ensure that the housing and the controller are not soaked with soap suds.

10.3 Cleaning the Sieve Insert

There is a sieve insert in the vacuum opening (5) of the CobotPump. Dust, shavings and other solid materials may accumulate in this sieve over time.

- ▶ If the performance drops noticeably, clean the sieve with a paintbrush.

If it is heavily soiled, you can send the CobotPump to Schmalz for repairs and replacement of the sieve (subject to a fee).

10.4 Replacement of the Device with a Parameterization Server

The IO-Link protocol provides an automated process for transferring data when a device is replaced. For this Data storage mechanism, the IO-Link master mirrors all setting parameters for the device in a separate non-volatile memory. When a device is swapped for a new one of the same type, the setting parameters for the old device are automatically saved in the new device by the master.

- ✓ The device is operated on a master with IO-Link revision 1.1 or higher.
- ✓ The Data storage feature in the configuration of the IO-Link port is activated.
 - ▶ Ensure that the new device is restored to the factory settings **before** it is connected to the IO-Link master. If necessary, reset the device to factory settings, e.g. via the operating element.
- ⇒ The device parameters are automatically mirrored in the master when the device is configured using an IO-Link configuration tool.
- ⇒ Changes to the parameters made in the user menu on the device or via NFC are mirrored in the master.

Changes to the parameters made by a PLC program using a function module are **not** automatically mirrored in the master.

- ▶ Manually mirroring data: After changing all the required parameters, execute ISDU write access to the System command parameter (index 2) with the ParamDownloadStore command (numerical value 5).



Use the Parameterization server function of the IO-Link master to ensure that no data is lost when switching the device.

11 Warranty

The CobotPump is guaranteed in accordance with our general terms of sale and delivery. The same applies to spare parts, provided that these are original parts supplied by us.

We are not liable for any damage resulting from the use of non-original spare parts or accessories.

The exclusive use of original spare parts is a prerequisite for the proper functioning of the CobotPump and for the validity of the warranty.

Wearing parts are not covered by the warranty.



NOTE

Use of non-original spare parts

Malfunctions or damage to the equipment

- ▶ Use only original and spare parts from J. Schmalz. Otherwise the warranty is void.

12 Spare and Wearing Parts, Accessories

12.1 Spare and Wearing Parts

Maintenance work may only be carried out by qualified personnel.



⚠ WARNING

Risk of injury due to incorrect maintenance or troubleshooting!

- ▶ Check the proper functioning of the product, especially the safety devices, after every maintenance or troubleshooting operation.

The following list contains the primary spare and wearing parts.

Designation	Part no.	Art
Bumper 1	10.03.01.00317	V
Bumper 2	10.03.01.00318	V
Set screw	20.05.07.00138	E
Legend:	E ...	Spare part
	V ...	Wearing part

12.2 Accessories

Designation	Part no.
Mounting on the robot side	
Flange plate for robot applications (for UR 3,5,10 – KUKA iiwa 7,14) ¹	10.03.01.00313
Flange plate for robot applications (for YASKAWA, Motoman HC10) ²	10.03.01.00357
Flange plate for robot applications (for RETHINK Sawyer without ClickSmartAdapter) ³	10.03.01.00358
Flange plate for robot applications (for RETHINK Sawyer with ClickSmartAdapter)	10.03.01.00373
Flange plate for robot applications (for FANUC, including CR series)	10.03.01.00390
Flange plate for robot applications (for YASKAWA, Motoman HC10, with recess for cable outlet)**	10.03.01.00357
Mounting on the suction cup side	
Flange plate for robot applications (universal with G1/4" internal thread)	10.03.01.00379
Flange module VEE-QCM 30 (VEE interface)	10.01.36.00121
Connection cable(s) and connection distributor	
Connection cable ASK B-M12-8 5000 K-8P (universal)	21.04.05.00079
Connection cable ASK B-M12-8 280 WB-M8-8 (for UR 3,5,10)	21.04.05.00350
Connection cable ASK B-12-8 220 WS-M12-8 (for RETHINK Sawyer with ClickSmartAdapter)	21.04.05.00368
Connection cable ASV ECBPi WS-M8-8 WS-M8-3 (for KUKA iiwa 7,14, MF electr.)	21.04.05.00361
Connection cable ASV ECBPi WS-M8-8 WS-M8-4 (for KUKA iiwa 7,14, MF pneum.)	21.04.05.00362

¹ according to EN ISO 9409-1 pitch diameter, d1, series 2, 50mm

² according to EN ISO 9409-1 pitch diameter, d1, series 1, 63mm

³ according to EN ISO 9409-1 pitch diameter, d1, series 1, 40mm

The accessory parts listed here are current as of the writing of the operating instructions. An up-to-date overview of all accessory parts for the CobotPump can be found on the web at www.schmalz.com

13 Troubleshooting

13.1 Error Messages in SIO Operation

In SIO operation, error messages are shown on the display of the CobotPump.

Code displayed	Explanation
E01	Electronics error – internal data management, EEPROM
E03	Zero-point adjustment for vacuum sensor is outside of the tolerance
E05	Actuator supply voltage U_A too low or not present
E07	Sensor supply voltage U_s too low
E08	IO-Link communication error
E12	OUT ₂ short circuit
E13	OUT ₃ short circuit
E15	Actuator supply voltage U_A too high
E17	Sensor supply voltage U_s too low
-FF	Overpressure in vacuum circuit

The error E01 remains in the display after being shown once.

- ▶ Clear the error by restoring the factory setting with the [rES] function or parameter in the configuration menu.

If the error E01 occurs again after the power supply is switched back on, then the device must be replaced.

13.2 Warnings and Error Messages in IO-Link Mode

Warnings and errors are issued via IO-Link. They are processed and evaluated accordingly in the higher-level control.

Warnings are only available via IO-Link.

In IO-Link mode, error messages are issued in various ways:

- Error messages on the display
- In the controller with system status indicators
- In the controller with warnings

The table below shows the limit values of the power supply voltage with the corresponding error messages and color coding of the system status indicators:

Voltage in volts	Error	Display in IO-Link
26.4	Overvoltage E17	Red
25.8	CM warning: voltage outside of valid range	yellow
	Ideal voltage range	green
21.1	CM warning: voltage outside of valid range	yellow
20.9	Undervoltage E07	Red

The hysteresis of the limit values is 0.2 volts.

At less than 18 volts of U_s , the pump is switched off.

Error in IO-Link mode

Error	Possible cause	Solution
No IO-Link communication	Electrical connection faulty	▶ Check electrical connection and PIN assignment
	Master not correctly configured	▶ Check configuration of the master Configure IO-Link port
	IODD connection does not work	▶ Check for the appropriate IODD.
	Incorrect input signal type with UR robots	▶ Set input signal type to NPN (in the configuration menu with the parameter [E3 I])

14 Decommissioning and recycling

14.1 Disposing of the Device

1. Dispose of the product properly after replacement or decommissioning.
2. Observe the country-specific guidelines and legal obligations for waste prevention and disposal.

Component	Material
Housing	PUR vacuum cast resin
Bumper 1 and 2	Elastomer
Inner components	Aluminum alloy, brass, stainless steel, POM, silicone
Sealing	NBR
Lubrication	Silicone-free
Screws	Galvanized steel

Materials Used

15 Appendix

See also

- 📄 ECBPI_CobotPump_Data Dictionary_00.PDF [▶ 60]
- 📄 ECBPi_CE_30.30.01.01452-01_DE-EN-FR-ES-IT-NL.pdf [▶ 65]

15.1 Factory Settings

Symbol	Function	Factory settings for the production setup profile P-0
H-1	Limit value H1	550 mbar
H-2	Limit value H2	400 mbar
h-2	Hysteresis h2	20 mbar
tBL	Release time	2.0 s
u n i	Vacuum unit	-bA, vacuum unit in mbar
tY0	Signal type	PNP, PNP switching
tP1	Signal type	PNP, PNP switching
cEr	Control function	on
bLo	Blow off function	-E-, externally controlled blowoff
dPY	Display	Std orientation: Display screen not rotated
P in	PIN code	000, no access lock activated
-L-	Leakage value	250 mbar/s
t-1	Evacuation time	1 s
o-2	Configuration output OUT2	no normally open contact
o-3	Configuration output OUT3	no normally open contact
dLY	Switch-off delay for o-2	10 ms
dPY	Display rotation	Std
Eco	ECO mode	off

Important for IO-Link mode: The factory settings of the production setup profiles P-1 to P-3 differ from those of P-0 (see (> See ch. Data Dictionary) in the appendix).

See also

- 📄 ECBPI_CobotPump_Data Dictionary_00.PDF [▶ 60]

15.2 Overview of Display Symbols

15.2.1 Showing the Seven-segment Display in the Basic Menu

Symbol	Function	Comment
H-1	Limit value H1	Deactivation value of control function
SPE	Power, Speed	Indicates the percentage of the pump capacity in SIO mode
H-2	Limit value H2	Switch-on value of the "Parts control" signal output (when NO output is configured)
h-2	Hysteresis h2	Hysteresis of "Parts control" signal output
tBL	Ventilation time	Ventilation time setting for time-controlled blowoff
cAL	Zero-point adjustment (calibration)	Calibrate vacuum sensor, zero point = ambient pressure

15.2.2 Showing the Seven-segment Display in the Configuration Menu

Symbol	Function	Comment
cEr	Energy-saving function, control function	<ul style="list-style-type: none"> For switching between control and speed settings Only for SIO mode (hidden in IO-Link mode)
oN	Switching on the control function	rotation speed control
oFF	Deactivation of control function	<ul style="list-style-type: none"> Sustained suction Rotation speed setting
-L-	Leakage rate	-L- setting for the maximum permissible leakage in mbar/s
t-i	Evacuation time	Maximum permitted evacuation time in milliseconds (ms) configurable
blO	Blow off function	Menu for configuring the blow off function
-E-	Externally controlled blowoff	The "Blowoff" valve is controlled directly via the "Blowoff" signal input.
i-t	Internally time-controlled blowoff	The "Blowoff" valve is automatically activated for the time period set as soon as the device leaves "Suction" mode.
E-t	Externally time-controlled blowoff	The blowoff pulse is controlled externally via the "Blowoff" input. (triggered externally, time can be set)
SSt	Soft Start	The startup current is limited to approx. 600 mA. The pump starts at approx. 30 percent power and over about 400 ms it ramps up to 90 percent.
o-2	Signal output 2	Configure signal output 2
o-3	Signal output 3	Configure signal output 3
no	Normally open contact	Configuration of the signal outputs as normally open contacts
nc	Normally closed contact	Configure the signal outputs as normally closed contacts
tYI	Transistor function of the inputs	NPN/PNP switching for the inputs
tYo	Transistor function of the outputs	NPN/PNP switching for the outputs
PnP	PNP signal type	All input and output signals switch according to PNP (input / output on = 24 V).
nPn	NPN signal type	All input and output signals switch according to NPN (input / output on = 0 V).
uN i	Vacuum unit	Vacuum unit in which display values are shown
-bA	Vacuum in mbar	The displayed vacuum is shown in mbar.
-PA	Vacuum in kPa	The displayed vacuum is shown in kPa.
-iH	Vacuum in inHg	The displayed vacuum is shown in inchHg.
PS i	Vacuum level in psi	The displayed vacuum level is shown in psi.
dLY	Switch-off delay	Configure the switch-off delay of OUT ₂
dPY	Display	Parameter for rotating the display screen
Std	Default display setting	Display screen not rotated (default)
rEd	Display setting rotated	Display screen rotated by 180°
Eco	ECO mode	Setting ECO mode
oFF	No ECO mode	ECO mode deactivated – the display remains on
Lo	Display dimmed	The brightness of the display is reduced by 50 percent.
oN	ECO mode on	ECO mode is activated – the display switches off

Symbol	Function	Comment
PIN	PIN code	Entry of the PIN code for unlocking the menu
LOC	Menu locked	The keypad remains locked after an incorrect PIN code is entered.
UNL	Menu locked (unlock)	The buttons and menus are unlocked.
RES	"Clear all" (reset)	Reset values to factory settings

15.2.3 Showing the Seven-segment Display in the System Menu

Symbol	Function	Comment
CC1	Counter 1	Counter for suction cycles (suction signal input)
CC2	Counter 2	Shows the operating time of the pump in hours
SOV	Software version	Displays the current software version
PRT	Part number	The part number is displayed
SNR	Serial number	The serial number is displayed



J. Schmalz GmbH
 Johannes-Schmalz-Str. 1, D 72293 Glatten
 T: +49 7443 2403-0
 schmalz@schmalz.de



IO-Link Implementation

		IO-Link Version 1.1
Vendor ID		234 (0x00EA)
Device ID		100310 (0x0187D6)
SIO-Mode		Yes
Baudrate		38.4 kBd (COM2)
Minimum cycle time		3.4 ms
Processdata input		4 byte
Processdata output		2 byte

Process Data

Process Data In	Name	Bits	Access	Remark
PD In Byte 0	Signal H2 (part present)	0	ro	Vacuum is over H2 & not yet under H2-h2
	Signal H1 (in Control range)	1	ro	Vacuum value within In setpoint area (only in setpoint mode)
	control mode	2	ro	1 = Speed demand 0 = setpoint for control
	CM-Autoreset acknowledged	3	ro	Acknowledge that the Autoreset function has been completed
	EPC-Select acknowledged	4	ro	Acknowledge that EPC values 1 and 2 have been switched according to EPC-Select: 0 - EPC-Select = 00 1 - otherwise
	Signal H3 (part detached)	5	ro	The part has been detached after a suction cycle
	Device status	7..6	ro	00 - [green] Device is working optimally 01 - [yellow] Device is working but there are warnings 10 - [orange] Device is working but there are severe warnings 11 - [red] Device is not working properly
PD In Byte 1	EPC value 1	7...0	ro	EPC value 1 (byte) Holds 8bit value as selected by EPC-Select (see PD Out Byte 0)
PD In Byte 2	EPC value 2, high-byte	7...0	ro	EPC value 2 (word) Holds 16bit value as selected by EPC-Select (see PD Out Byte 0)
PD In Byte 3	EPC value 2, low-byte	7...0	ro	EPC value 2 (word) Holds 16bit value as selected by EPC-Select (see PD Out Byte 0)
Process Data Out	Name	Bits	Access	Remark
PD Out Byte 0	Vacuum	0	wo	Vacuum on/off
	Drop-off	1	wo	Activate Drop-off
	control mode	2		1 = Speed demand 0 = setpoint for control
	CM Autoreset	3	wo	Perform CM Autoreset function
	EPC-Select	5..4	wo	Select the function of EPC values 1 and 2 in PD In (content is 2 bit binary coded integer) 0: EPC value 1 = actual power in % EPC value 2 = System vacuum (1 mbar) 1: EPC value 1 = CM-Warnings (see ISDU 146 for bit definitions) EPC value 2 = Evacuation time t1 (1 msec) 2: EPC value 1 = Leakage of last suction cycle (1 mbar/sec) max. 255 mbar EPC value 2 = Last measured free-flow vacuum (1 mbar) 3: EPC value 1 = Primary supply voltage (0.1 Volt) max.25.5V EPC value 2 = Energy consumption of last suction cycle (Ws)
Profile-Set	7..6	wo	Select Production Profile (content is 2-bit binary coded integer) 0: Activate Production Setup Profile P0 1: Activate Production Setup Profile P1 2: Activate Production Setup Profile P2 3: Activate Production Setup Profile P3	
PD Out Byte 1	Vacuum demand / setpoint for control	7...0	wo	Vacuum demand in % / setpoint for control mode 1 in 10 mbar



J. Schmalz GmbH
 Johannes-Schmalz-Str. 1, D 72293 Glatten
 T: +49 7443 2403-0
 schmalz@schmalz.de



ISDU Parameters

(all ISDUs use subindex 0 only)

ISDU Index dec	hex	Subindex dec	Display Appearance	Parameter	Data width	Value range	Access	Default value	Remark
Identification									
Device Management									
16	0x0010	0		Vendor name	15 bytes		ro	J. Schmalz GmbH	Manufacturer designation
17	0x0011	0		Vendor text	15 bytes		ro	www.schmalz.com	Internet address
18	0x0012	0		Product name	32 bytes		ro	ECBPI	General product name
19	0x0013	0		Product ID	32 bytes		ro	ECBPI	General product name
20	0x0014	0		Product text	30 bytes		ro	ECBPI	Order-Code (partial); for complete Order-Code read Index 0xFE
21	0x0015	0		Serial number	9 bytes		ro	999000002	Serial number
22	0x0016	0		Hardware revision	2 bytes		ro	02	Hardware revision
23	0x0017	0		Firmware revision	4 bytes		ro	1.00	Firmware revision
240	0x00F0	0		Unique Device Identification	20 bytes		ro	101421221005502341003101	10,14,2,1,3,2,2,0,100,2,38,0,234,Device ID, SerNr.,
241	0x00F1	0		Feature List	11 bytes		ro	101421322100550	10,14,2,1,3,2,2,0,100,2,38
250	0x00FA	0		Article number	14 bytes		ro	10.03.01.00314	Order-Nr.
251	0x00FB	0		Article revision	2 bytes		ro	01	Article revision
252	0x00FC	0		Production Code	3 bytes		ro	H17	code of production
254	0x00FE	0		Product text (detailed)	64 bytes		ro	ECBPI 12 24V-DC M12-8	Order-Code (complete)
Device Localization									
24	0x0018	0		Application specific tag	0...32 bytes		nw	***	Deviceidentification
242	0x00F2	0		Equipment identification: (tag 3)	64 bytes		nw	***	Installationidentification
246	0x00F6	0		Geolocation	64 bytes		nw	***	OPC-UA Companion standard for auto-ID
247	0x00F7	0		Weblink to IODD	64 bytes		nw	www.schmalz.com/xxx/	User string to store web link to IODD file
248	0x00F8	0		LINK to IOT-Server	64 bytes		nw	myproduct.schmalz.com	Web link to NFC app (base URL for NFC tag)
249	0x00F9	0		Storage location (tag 2)	0...32 bytes		nw	***	User string to store storage location
253	0x00FD	0		Installation Date	16 bytes		nw	***	User string to store date of installation
Parameter									
Device Settings									
Commands									
2	0x0002	0		System command	1 byte	5, 130, 165, 167, 168, 169	wo	0	0x05 (dec 5): Force upload of parameter data into the master 0x52 (dec 130): Reset device parameters to factory defaults 0xA5 (dec 165): Calibrate vacuum sensor 0xA7 (dec 167): Reset erasable counter 0xA8 (dec 168): Reset voltage min/max (Sensor & Actor) & Temperatur 0xA9 (dec 169): Reset vacuum min/max
Access Control									
12	0x000C	0		Device access locks	2 bytes	0, 2, 4	nw	0	Bit 0: reserved Bit 1: no action Bit 2: local parameterization lock (lock menu editing, value not changeable)
77	0x004D	0	Pin	Menu PIN code	2 bytes	0 - 999	nw	0	0 = menu editing unlocked >0 = menu editing locked with pin-code
90	0x005A	0		Extended Device Access Locks	1 byte	0 - 3 8-10 16-19 24-27	nw	0	Bit 0: NFC write lock Bit 1: NFC disable Bit 2: reserved Bit 3: local user interface locked (manual mode locked) Bit 4: IO-Link event lock (suppress sending IO-Link events) Bit 5-7: reserved
91	0x005B	0		NFC PIN code	2 bytes	0-999	nw	0	Pass code for writing data from NFC app
Initial settings									
69	0x0045	0	bLo	Blow-off mode	1 byte	0 - 2	nw	0	0 = Externally controlled lay-down (-E-) 1 = Internally controlled lay-down - time-dependent (I-I) 2 = Externally controlled lay-down - time-dependent (E-I)
70	0x0046	0	SST	SoftStart	1 byte	0-1	nw	0	0 = no SoftStart 1 = SoftStart
71	0x0047	0	o-2	OUT2 function	1 byte	0 - 1	nw	0	0 = NO 1 = NC
72	0x0048	0	o-3	OUT3 function	1 byte	0 - 1	nw	0	0 = NO 1 = NC
73	0x0049	1	YI	Signal type Input	1 byte	0 - 1	nw	0	0 = PNP 1 = NPN
73	0x0049	2	YO	Signal type Output	1 byte	0 - 1	nw	0	0 = PNP 1 = NPN
74	0x004A	0	uni	Vacuum display unit	1 byte	0 - 3	nw	0	0 = mbar 1 = kPa 2 = inHg 3 = psi
75	0x004B	0	dLY	Output filter	1 byte	0 - 3	nw	1	0 = Off 1 = 10ms 2 = 50ms 3 = 200ms
76	0x004C	0	Eco	Eco-Mode (after 1 min)	1 byte	0 - 2	nw	0	0 = off 1 = on (full eco mode with display switching off , only one point) 2 = Lo (medium eco mode with display dimmed to 50%)
79	0x004F	0	dpy	Display rotation	1 byte	0 - 1	nw	0	0 = standard 1 = rotated



J. Schmalz GmbH
 Johannes-Schmalz-Str. 1, D 72293 Glatten
 T: +49 7443 2403-0
 schmalz@schmalz.de



Process Settings

Production Setup - Profile P0

78	0x004E	0	ctr	control mode vacuum/speed	1 bytes	0-1	rw	0	0 = vacuum as controlled value 1 = motor speed as controlle value
100	0x0064	0	H-1	Setpoint H1	2 bytes	(998 >= H1 >= (H2+H1*0.1)) & (H1 > H2+10)	rw	550	H1 - 10% has to be over H2 Unit: 1 mbar bzw. kPa, inHg, psi
101	0x0065	0	SPE	Speed in %	1 bytes	0-100	rw	100	Unit: %
102	0x0066	0	H-2	Setpoint H2	2 bytes	(H1*0.9 >= H2 >= (h2+2))	rw	400	Unit: 1 mbar
103	0x0067	0	h-2	Hysterisis h2	2 bytes	(H2-2) >= h2 >= 10	rw	20	Unit: 1 mbar
106	0x006A	0	tbL	Duration automatic drop off (LayDownTime)	2 bytes	100 - 9999	rw	2000	Unit: 1 ms
107	0x006B	0	t-1	Permissible evacuation time (t1)	2 bytes	0, 10 - 9999	rw	1000	Unit: 1 ms
108	0x006C	0	-L-	Permissible leakage rate (L)	2 bytes	1-999	rw	250	Unit: 1 mbar/sec
119	0x0077	0		Profile name	1...32 bytes		rw	***	

Production Setup - Profile P1

181	0x00B5	0	ctr		1 bytes	0-1	rw	0	Profile P-1 (selected by PD Out 0 - Profile-Set = 1)
182	0x00B6	0		Setpoint H1	2 bytes	998 >= H1 >= (H2+H1*0.1)	rw	400	
183	0x00B7	0		Speed SPE in %	1 bytes	0-100	rw	100	
184	0x00B8	0		Setpoint H2	2 bytes	(H1*0.9 >= H2 >= (h2+2))	rw	300	
185	0x00B9	0		Hysterisis h2	2 bytes	(H2-2) >= h2 >= 10	rw	15	
186	0x00BA	0		Duration automatic drop off (LayDownTime)	2 bytes	100 - 9999	rw	1500	
187	0x00BB	0		Permissible evacuation time	2 bytes	0, 10 - 9999	rw	400	
188	0x00BC	0		Permissible leakage rate	2 bytes	1 - 999	rw	250	
199	0x00C7	0		Profile name	1...32 bytes		rw	***	

Production Setup - Profile P2

201	0x00C9	0	ctr		1 bytes	0-1	rw	0	Profile P-2 (selected by PD Out 0 - Profile-Set = 2)
202	0x00CA	0		Setpoint H1	2 bytes	998 >= H1 >= (H2+H1*0.1)	rw	600	
203	0x00CB	0		Speed SPE in %	1 bytes	0-100	rw	100	
204	0x00CC	0		Setpoint H2	2 bytes	(H1*0.9) >= H2 >= (h2+2)	rw	500	
205	0x00CD	0		Hysterisis h2	2 bytes	(H2-2) >= h2 >= 10	rw	15	
206	0x00CE	0		Duration automatic drop off (layDownTime)	2 bytes	100 - 9999	rw	2000	
207	0x00CF	0		Permissible evacuation time	2 bytes	0, 10 - 9999	rw	600	
208	0x00D0	0		Permissible leakage rate	2 bytes	1 - 999	rw	250	
219	0x00DB	0		Profile name	1...32 bytes		rw	***	

Production Setup - Profile P3

221	0x00DD	0	ctr		1 bytes	0-1	rw	0	Profile P-3 (selected by PD Out 0 - Profile-Set = 3)
222	0x00DE	0		Setpoint H1	2 bytes	998 >= H1 >= (H2+H1*0.1)	rw	700	
223	0x00DF	0		Speed SPE in %	1 bytes	0-100	rw	100	
224	0x00E0	0		Setpoint H2	2 bytes	(H1*0.9) >= H2 >= (h2+2)	rw	600	
225	0x00E1	0		Hysterisis h2	2 bytes	(H2-2) >= h2 >= 10	rw	15	
226	0x00E2	0		Duration automatic drop off (layDownTime)	2 bytes	100 - 9999	rw	2000	
227	0x00E3	0		Permissible evacuation time	2 bytes	0, 10 - 9999	rw	1000	
228	0x00E4	0		Permissible leakage rate	2 bytes	1-999	rw	250	
239	0x00EF	0		Profile name	1...32 bytes		rw	***	



J. Schmalz GmbH
 Johannes-Schmalz-Str. 1, D 72293 Glatten
 T: +49 7443 2403-0
 schmalz@schmalz.de



<div style="text-align: left;"> ☰ Observation </div>								
<div style="text-align: left;"> ☰ Monitoring </div>								
<div style="text-align: left;"> ☰ Process Data </div>								
40	0x0028	0	Process Data In Copy	see PD in		ro	-	Copy of currently active process data input (length see above)
41	0x0029	0	Process Data Out Copy	see PD out		ro	-	Copy of currently active process data output (length see above)
64	0x0040	0	Vacuum Value	6 bytes		ro	-	subindex 0 for access to all primary supply voltage values
64	0x0040	1	Vacuum Value, live	2 bytes		ro	-	Vacuum Value as measured by the device
64	0x0040	2	Vacuum Value, min	2 bytes		ro	-	min. value of Vacuum Value as measured by the device - rest by ISDU 0x0002
64	0x0040	3	Vacuum Value, max	2 bytes		ro	-	max. value of Vacuum Value as measured by the device-rest by ISDU 0x0002
66	0x0042	0	Primary supply voltage	6 bytes		ro	-	subindex 0 for access to all primary supply voltage values
66	0x0042	1	Primary supply voltage, live	2 bytes		ro	-	Primary supply voltage (US) as measured by the device (unit: 0.1 Volt)
66	0x0042	2	Primary supply voltage, min	2 bytes		ro	-	min. value of primary supply voltage (unit: 0.1 Volt) - rest by ISDU 0x0002
66	0x0042	3	Primary supply voltage, max	2 bytes		ro	-	max. value of primary supply voltage (unit: 0.1 Volt) - rest by ISDU 0x0002
67	0x0043	0	Auxiliary supply voltage	6 bytes		ro	-	subindex 0 for access to all auxiliary supply voltage values
67	0x0043	1	Auxiliary supply voltage, live	2 bytes		ro	-	Auxiliary supply voltage (UA) as measured by the device (unit: 0.1 Volt)
67	0x0043	2	Auxiliary supply voltage, min	2 bytes		ro	-	min. value of auxiliary supply voltage (unit: 0.1 Volt) - rest by ISDU 0x0002
67	0x0043	3	Auxiliary supply voltage, max	2 bytes		ro	-	max. value of auxiliary supply voltage (unit: 0.1 Volt) - rest by ISDU 0x0002
68	0x0044	1	Temperature live	2 bytes		ro		Temperature (unit 0,1 °C)
68	0x0044	2	Temperature min	2 bytes		ro		Lowest measured Temperature since power-up (unit 0,1 °C)
68	0x0044	3	Temperature max	2 bytes		ro		Highest measured Temperature since power-up (unit 0,1 °C)
148	0x0094	0	Evacuation time t0	2 bytes		ro		Time from start of suction to H2 (unit: 1 ms)
149	0x0095	0	Evacuation time t1	2 bytes		ro		Time from H2 to H1 (unit: 1 ms)
160	0x00A0	0	Leakage rate	2 bytes		ro		Leakage of last suction cycle (unit: 1 mbar/sec)
161	0x00A1	0	Free-flow vacuum	2 bytes		ro		Last measured free-flow vacuum (unit: 1 mbar)
164	0x00A4	0	Max. reached vacuum in last cycle	2 bytes		ro		Maximum vacuum value of last suction cycle
<div style="text-align: left;"> ☰ Communication Mode </div>								
564	0x0234	0	Communication Mode	1 byte		ro		Currently active communication mode: 0x00 = SIO mode 0x10 = IO-Link Revision 1.0 (set by master) 0x11 = IO-Link Revision 1.1 (set by master)
<div style="text-align: left;"> ☰ Counters </div>								
140	0x008C	0	cc1	Vacuum-on counter	4 bytes	ro		Total number of suction cycles (stored all 300 cycles)
141	0x008D	0	cc2	total time of suction	4 bytes	ro		total time of suction (unit sec.) (stored all 50 sec.)
142	0x008E	0	cc3	Condition Monitoring counter	4 bytes	ro		Total number of warnings (stored all 50 sec.)
143	0x008F	0	ct1	Vacuum-on counter	4 bytes	ro		Can be reset by System Command "Reset erasable counters"
144	0x0090	0	ct2	total time of suction	4 bytes	ro		Can be reset by System Command "Reset erasable counters"
145	0x0091	0	ct3	Condition Monitoring counter	4 bytes	ro		Can be reset by System Command "Reset erasable counters"



J. Schmalz GmbH
 Johannes-Schmalz-Str. 1, D 72293 Glatten
 T: +49 7443 2403-0
 schmalz@schmalz.de



Diagnosis								
Device Status								
32	0x0020	0	Error Count	2 byte		ro	-	Errors since power-on or reset
36	0x0024	0	Device Status	1 byte		ro	-	0 = Device is operating properly (GN) 1 = Maintenance required (Yellow) 2 = Out of Spec (Yellow - Red) 3 = Functional check (Yellow - Red) 4 = Failure (red)
37	0x0025	0	Detailed Device Status	20*3byte		ro		Information about currently pending events (Event-List) Byte 1: 0x74 = error, 0xE4 = warning, 0xD4 = message Byte 2..3 = ID Event Code (see below)
138	0x008A	1	Extended Device Status - Type	1 byte		ro		Extended Device Status - Type (see below) 0x10: Device operation properly
138	0x008A	2	Extended Device Status - ID	2 byte		ro		Event Code of current device status (see table below)
139	0x008B	0	NFC Status	1 byte		ro		Result of recent NFC activity: 0x00: Data valid, write finished successfully 0x23: Write failed: Write access locked 0x30: Write failed: parameter(s) out of range 0x31: value greater then limit 0x32: value lesser then limit 0x41: Write failed: parameter set inconsistent 0xA1: Write failed: invalid authorisation 0xA2: NFC not available 0xA3: Write failed: invalid data structure 0xA5: Write pending 0xA6: NFC internal error
130	0x0082	0	Active error code	1 byte		ro		00 = No error Bit 0 = Elektronik error Bit 1 = Sensor Voltage to low Bit 2 = Sensor Voltage overrun Bit 3 = Actor Voltage to low Bit 4 = Actor Voltage overrun Bit 5 = Sensor Voltage less then 18V Bit 6 = Sensor calibration failed Bit 7 = reserved EEPROM
Condition Monitoring [CM]								
146.0	0x0092	0	Condition monitoring	1 Bit		ro		reserved
146.1	0x0092	0	Condition monitoring	1 Bit		ro		1 = Evacuation time t1 above limit [t-1] last cycle
146.2	0x0092	0	Condition monitoring	1 Bit		ro		1 = Leakage rate above limit [-L-] last cycle
146.3	0x0092	0	Condition monitoring	1 Bit		ro		1 = H1 not reached in suction cycle last cycle
146.4	0x0092	0	Condition monitoring	1 Bit		ro		1 = Free-flow vacuum > (H2-h2) but < H1 last cycle
146.5	0x0092	0	Condition monitoring	1 Bit		ro		1 = Primary voltage US outside of optimal range
146.6	0x0092	0	Condition monitoring	1 Bit		ro		1 = Actuator voltage UA outside of optimal range
146.7	0x0092	0	Condition monitoring	1 Bit		ro		Temperature over 50°C
Energy Monitoring [EM]								
157	0x009D		Energy consumption per cycle	2 bytes		ro		Energy consumption of last suction cycle (unit: 1 Ws)
Predictive Maintenance [PM]								
162	0x00A2	0	Quality (tightness)	1 byte		ro		Quality of last suction cycle (unit: 1 %)
163	0x00A3	0	Performance (flow)	1 byte		ro		Last measured performance level (unit: 1 %)

Event Codes of IO-Link Events and ISDU 138 (Extended Device Status)

Event code		Event name	Event type	Extended Device Status -Type	Remark
dec	hex				
4096	0x1000	General malfunction	Error	0x81 Defect lower	E01: internal error
6144	0x1800	Calibration OK	Notification	-	Calibration offset 0 set successfully
6145	0x1801	Calibration failed	Notification	-	E03: Sensor calibration failed
35841	0x8C01	Simulation active	Warning	0x21 Warning lower	Manual Mode activ
20736	0x5100	General Power supply fault	Error	0x42 Critical Condition upper	E07:Primary supply Voltage US to low (21.6/18,8V)
20752	0x5110	Primary supply voltage overrun	Warning	0x42 Critical Condition upper	E17: Primary supply Voltage US to high (26,4/28V)
20754	0x5112	Actor voltage to low	Warning	0x42 Critical Condition upper	E05: Actor Voltage UA to low (21,6/18,8V)
6162	0x1812	Actor voltage overrun	Warning	0x42 Critical Condition upper	E15: Actor Voltage UA to high (26,4/ 28V)
6156	0x180C	CM:Primary voltage US outside of optimal range	Warning	0x22 Warning upper	Primary voltage US outside of optimal range
6157	0x180D	CM:Actor voltage UA outside of optimal range	Warning	0x22 Warning upper	Actor voltage UA outside of optimal range
16384	0x4000	CM: temperature out of range	Warning	0x22 Warning upper	temperature over 50°C
6152	0x1808	CM: Evacuation time t1 above limit [t-1]	Warning	0x21 Warning lower	Evacuation time t1 above limit [t-1]
6153	0x1809	CM: Leakage rate above limit [-L-]	Warning	0x21 Warning lower	Leakage rate above limit [-L-]
6154	0x180A	CM: H1 not reached in suction cycle	Warning	0x22 Warning upper	H1 not reached in suction cycle
6155	0x180B	CM: Free-flow vacuum > (H2-h2) but < H1	Warning	0x21 Warning lower	Free-flow vacuum > (H2-h2) but < H1
6161	0x1811	EEPROM Error	Error	0x81 Defect lower	wrong Data in EEPROM or EEPROM fault

DE EU-Konformitätserklärung
 EN EC- Declaration of Conformity
 FR CE-Déclaration de conformité
 ES Certificado de conformidad CE
 IT Dichiarazione di conformità CE
 NL CE Conformiteitsverklaring



Hersteller / Manufacturer / Fabricant / Fabricante / Produttore / Fabrikant

J. Schmalz GmbH, Johannes-Schmalz-Str. 1, D - 72293 Glatten

Produktbezeichnung / Product name / Designation du produit /
 Denominación del producto / Denominazione del prodotto /
 Beschrijving van de machine

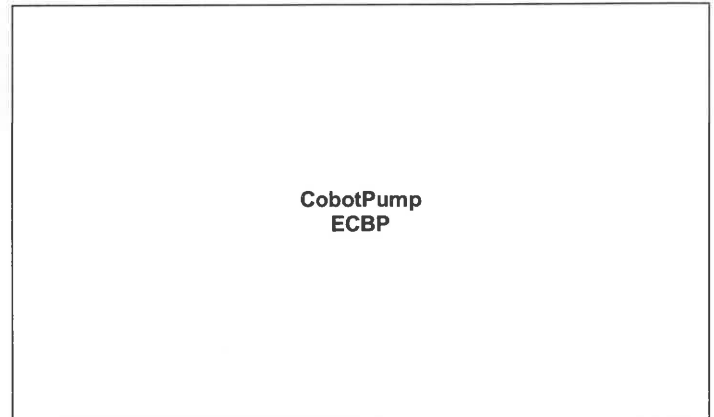

Elektrischer Vakuumerzeuger / Electric vacuum generator /
 Générateur de vide électrique / Generador de vacío eléctrica /
 Generatore di vuoto elettrico / Electric vacuüm generator

Erfüllte einschlägige EU-Richtlinien / Applicable EC directives met / Directives CE applicables respectées / Directivas vigentes de la CE cumplidas /
 Direttive CE applicate ed osservate / Nagekomen betreffende EG-richtlijnen

- | | |
|------------|---|
| 2006/42/EG | Maschinenrichtlinie / Machinery Directive / Directive sur les machines / Directiva para máquinas / Direttiva macchine /
Machinerichtlijn |
| 2014/30/EU | Elektromagnetische Verträglichkeit / Electromagnetic Compatibility / Compatibilité électromagnétique / Compatibilidad
electromagnética / Compatibilità elettromagnetica / Elektromagnetische compatibiliteit |

Angewendete harmonisierte Normen / Harmonised standards applied / Normes d'harmonisation appliquées / Normas armonizadas aplicadas / Norme
 armonizzate adottate / Toegepaste geharmoniseerde normen

- | | |
|--|--|
| EN ISO 12100: 2011-03 | Sicherheit von Maschinen - Grundbegriffe, allgemeine Gestaltungsleitsätze - Risikobeurteilung / Safety of Machinery -
Basic concepts, general principles for design – Risk assessment / Sécurité des machines - Notions fondamentales,
principes généraux de conception - Appréciation du risque / Seguridad de máquinas - Conceptos básicos, principios
generales de diseño – Estimación del riesgo / Sicurezza delle macchine - concetti fondamentali, principi generali della
progettazione – Valutazione dei rischi / Veiligheid van machines - basisbegrippen, algemene eisen voor het ontwerp en de
constructie - Risicobeoordeling |
| EN 61000-6-3: 2012-11
EN 61000-6-4: 2011-09 | Elektromagnetische Verträglichkeit - Störaussendung / Electromagnetic Compatibility - Emission / Compatibilité
électromagnétique – Norme sur l'émission / Compatibilidad electromagnética – Emisión de interferencias / Compatibilità
elettromagnetica – Norma generica sull'emissione / Elektromagnetische compatibiliteit - emissie |
| EN 61000-6-1: 2007-10
EN 61000-6-2: 2006-03 | Elektromagnetische Verträglichkeit - Störfestigkeit / Electromagnetic Compatibility - Immunity / Compatibilité
électromagnétique – Immunité / Compatibilidad electromagnética – Resistencia a interferencias / Compatibilità
elettromagnetica – Immunità / Elektromagnetische compatibiliteit - immunititeit |
| EN ISO 9409-1: 2004-03 | Industrieroboter - mechanische Schnittstellen / Industrial robots - mechanical interfaces / Robot industriel - interfaces
mécaniques / Robots industriels - interfaces mecánicas / Robot industriali - Elementi del dispositivo / Industriële robots -
Mechanische interfaces |
| EN ISO 10218-2:
2012-06 | Industrieroboter - Sicherheitsanforderungen - Teil 2: Robotersysteme und Integration / Robots for industrial environments -
Safety requirements - Part 2: Robotic systems and integration / Robots industriels - Prescriptions de sécurité - Partie 2:
Systèmes robotiques et l'intégration / Robot industriales - Requisitos de seguridad - Parte 2: Sistemas robóticos y la
integración / Robot in ambiente industriale — Requisiti per la sicurezza — Parte 2: Sistemi robotici e integrazione / Robots
voor industriële omgevingen - Veiligheidseisen - Deel 1: Robotssystemen en Integratie |



Dokumentationsverantwortlicher / Person responsible for documentation / Responsable de la documentation / Responsable de documentación /
Responsabile della documentazione / Verantwoordelijk voor de documentatie

Glatten, 23.01.2018

/ i.A.

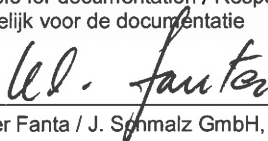

Klaus-Dieter Fanta / J. Schmalz GmbH, Johannes-Schmalz-Str. 1, D - 72293 Glatten

Unterschrift, Angaben zum Unterzeichner / Signature, details of signatory / Signature, indications sur le soussigné / Firma y datos del firmante / Firma,
dati concernenti il firmatario / Handtekening, omschrijving van de ondertekenaar

Glatten, 23.1.18



Walter Dunkmann
Leiter Geschäftsfeld, Vakuum-Automation /
Head of Business Unit, Vacuum Automation

At your side worldwide

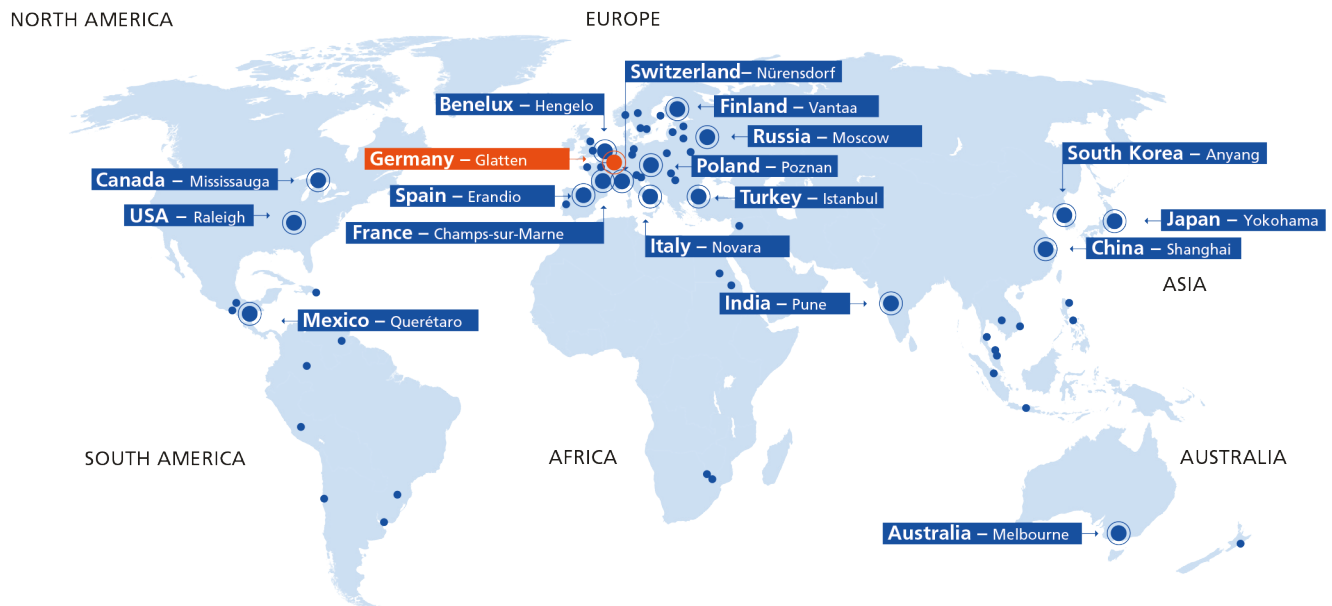

● Headquarters

Schmalz Germany – Glatten

• Sales Partners

You can find the Schmalz sales partner in your country at:
WWW.SCHMALZ.COM/SALESNETWORK

● Subsidiaries

- Schmalz Australia – Melbourne
- Schmalz Benelux – Hengelo (NL)
- Schmalz Canada – Mississauga
- Schmalz China – Shanghai
- Schmalz Finland – Vantaa
- Schmalz France – Champs-sur-Marne
- Schmalz India – Pune
- Schmalz Italy – Novara
- Schmalz Japan – Yokohama

- Schmalz Mexico – Querétaro
- Schmalz Poland – Suchy Las (Poznan)
- Schmalz Russia – Moscow
- Schmalz South Korea – Anyang
- Schmalz Spain – Erandio (Vizcaya)
- Schmalz Switzerland – Nürens Dorf
- Schmalz Turkey – Istanbul
- Schmalz USA – Raleigh (NC)

Vacuum Automation

WWW.SCHMALZ.COM/AUTOMATION

Handling Systems

WWW.SCHMALZ.COM/HANDLINGSYSTEMS

J. Schmalz GmbH
 Johannes-Schmalz-Str. 1
 72293 Glatten, Germany
 T: +49 7443 2403-0
 schmalz@schmalz.de
 WWW.SCHMALZ.COM