

Innovative Vacuum for Automation

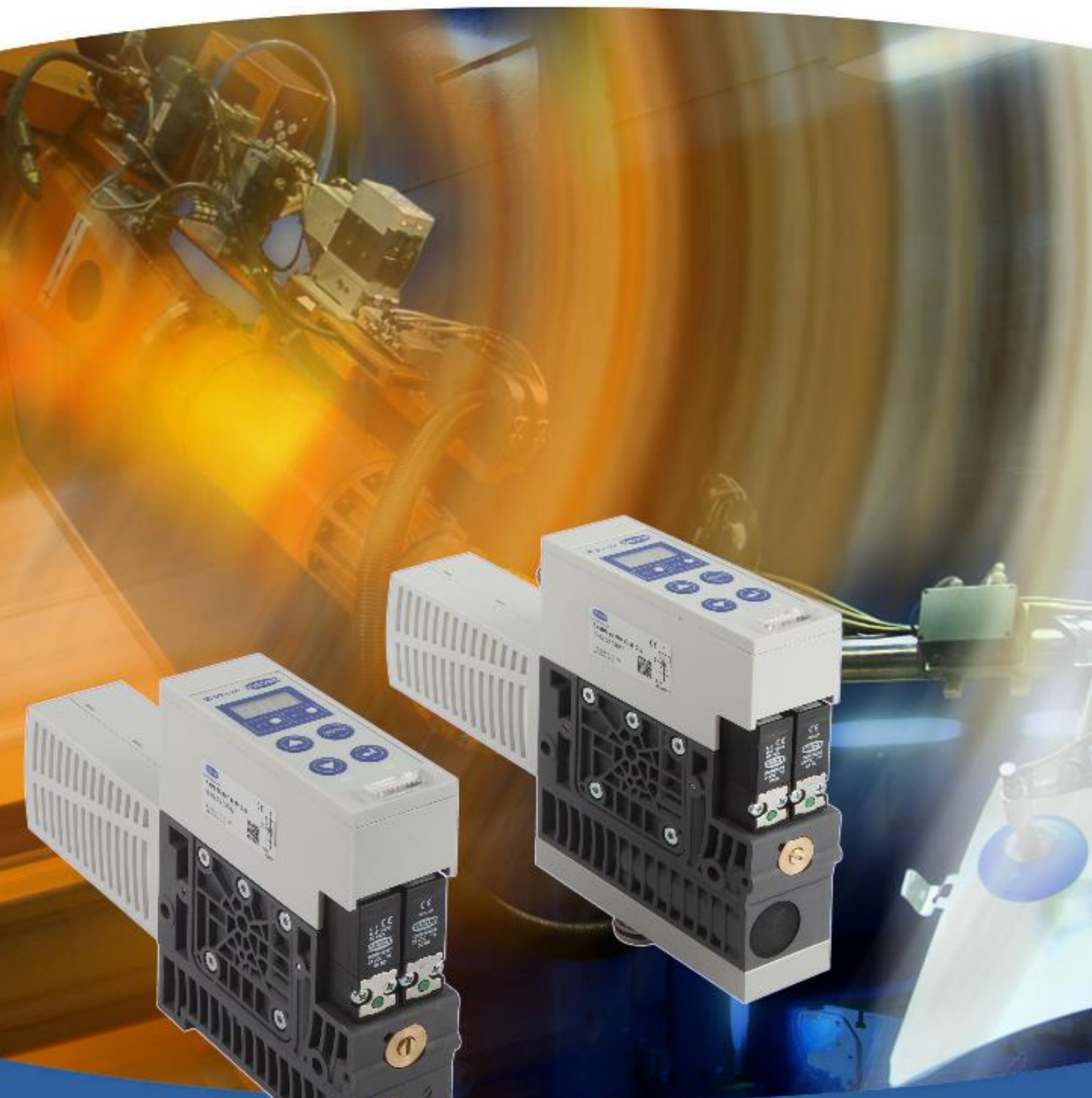

 **IO-Link**



EN

Schmalz X-Pump – SXPi/SXMPi

CONTENTS

1	Safety Instructions	1-5
	Important symbols	1-5
	General safety instructions	1-5
	Intended use	1-6
	Installation and operation	1-7
2	Product Overview	2-8
	General description of functions	2-8
	Vacuum generation (picking up the workpiece)	2-8
	Blow-off (depositing the workpiece)	2-9
	Vacuum/pressure display	2-9
	IO-Link	2-9
	Versions	2-10
	Ejector version PNP or NPN	2-10
	Additional function PC	2-10
	Electrical connection	2-11
	Ejector design	2-12
	Basic model	2-12
	Expansion modules	2-13
	Operating and display elements	2-14
3	Description of Functions	3-16
	Operating modes	3-16
	Control concept for NO ejectors	3-18
	Control concept for NC ejectors	3-18
	Control concept for IMP ejectors	3-18
	General functions	3-19
	Manual mode	3-19
	Set-up mode	3-20
	Monitoring the system vacuum	3-20
	Monitoring the system pressure	3-20
	Zero-point adjustment of the sensors (calibration)	3-21
	Control function	3-21
	Control shutoff	3-22
	Blow-off modes	3-23
	Signal outputs	3-23
	Selecting the vacuum and pressure units	3-24
	Switch-off delay for the signal outputs	3-25
	ECO mode	3-25
	PIN for write protection	3-25
	Reset to factory settings	3-26
	Counters	3-26
	Power failure	3-27
	Setting the blow-off volume flow	3-27
	Condition monitoring [CM]	3-28
	Monitoring the valve switching frequency	3-28
	Monitoring the control threshold	3-28
	Monitoring the evacuation time	3-28
	Monitoring leakage	3-29
	Monitoring the operating pressure	3-29
	Monitoring the dynamic pressure	3-29

	Diagnostics output.....	3-30
	Status indicator when a condition monitoring function is active.....	3-30
	Diagnostics/analysis function.....	3-32
	Evaluation of the leakage rate.....	3-33
	Measurement of the evacuation time t_0	3-33
	Measurement of the evacuation time t_1	3-33
	Energy monitoring [EM].....	3-33
	Percentual air consumption measurement.....	3-33
	Absolute air consumption measurement.....	3-34
	Energy consumption measurement.....	3-34
	Predictive maintenance [PM].....	3-34
	Measurement of the leakage.....	3-34
	Measurement of the dynamic pressure.....	3-34
	Quality assessment.....	3-34
	Performance calculation.....	3-35
4	Operating and Menu Concepts.....	4-36
	Individual functions.....	4-36
	Pressure display.....	4-36
	Vacuum/pressure units.....	4-36
	Operating mode display.....	4-37
	Main menu.....	4-37
	Setting the parameters in the main menu.....	4-38
	Zero-point adjustment (calibration).....	4-38
	Configuration menu.....	4-39
	Setting the parameters in the configuration menu.....	4-41
	Entering the PIN.....	4-41
	Executing the “reset to factory settings” function.....	4-41
	System menu.....	4-42
	Displaying counters.....	4-43
	Erasing a counter.....	4-43
	Software version.....	4-43
	Serial number.....	4-44
	Article number.....	4-44
5	Operating Mode.....	5-45
	SIO operating mode.....	5-45
	Overview.....	5-45
	Mounting.....	5-46
	Pneumatic connection.....	5-46
	Electrical connection.....	5-47
	Pin assignment of the connection plug.....	5-48
	Project planning.....	5-49
	Start of operations.....	5-49
	Warnings and errors.....	5-50
	IO-Link mode.....	5-51
	Overview.....	5-51
	Mounting.....	5-52
	Pneumatic connection.....	5-52
	Electrical connection.....	5-53
	Pin assignment of the connection plug.....	5-54
	Project planning.....	5-55
	Start of operations.....	5-60
	Warnings and errors.....	5-62

6	Maintenance.....	6-63
	General maintenance	6-63
	Exterior soiling	6-63
	Silencer.....	6-63
	Screw-in/press-in filters	6-63
	Warranty, spare parts and wearing parts	6-63
	Spare and wearing parts	6-64
	Troubleshooting	6-64
	Accessories	6-64
 7	 Technical Data	 7-65
	Electrical parameters	7-65
	Display parameters	7-66
	Mechanical data.....	7-66
	General parameters	7-66
	Materials used	7-67
	Mechanical parameters	7-67
	Dimensions.....	7-67
	Pneumatic circuit diagrams	7-69
	Overview of display symbols	7-71
	Factory settings.....	7-73
 8	 Conformity Declaration.....	 8-74

1 SAFETY INSTRUCTIONS

IMPORTANT SYMBOLS



This symbol indicates important information and instructions.



Caution!

This symbol indicates a potentially dangerous situation. If it is not avoided, slight or minor injuries may result.



DANGER

Danger!

This symbol indicates an immediate hazard. If it is not avoided, death or serious injuries may result.

GENERAL SAFETY INSTRUCTIONS



- These operating instructions contain important information on using the ejector. Please read the operating instructions thoroughly and keep them for later reference.



DANGER

Never look into any open or closed vacuum vents (e.g. vacuum connections or suction pads).

Serious injuries could occur as a result. Eyes can be sucked in.

- Compressed air can cause closed containers to explode. A vacuum can cause closed containers to implode.
- The ejector may only be operated with a silencer. Never look into the exhaust air jet of the silencer.
- The ejector emits noise. We recommend wearing ear protection.
- This device is not intended for use with hazardous dust, oil mist, vapors or aerosols, etc. If drawn in, these materials will enter the exhaust air and may result in poisoning.
- Use only the connections, mounting holes and attachment materials that have been provided.
- Carry out mounting and removal only when the device is in an idle, depressurized state.
- No person may sit or stand in the area in which the load is to be transported.

- No person may sit or stand in the danger zone while the machine or system is in automatic mode.
- Components may be installed by trained specialist personnel only.
- Specialist personnel must be familiar with current safety rules and requirements. For example, these apply to the use of components such as solenoid valves and pressure switches as well as to controllers used in devices, machines and systems.
- Specialist personnel must also be familiar with the system's control concept. In particular, they must be familiar with the system's redundant control components and feedback signals.

INTENDED USE

The ejector is designed to generate a vacuum for gripping and transporting objects when used in conjunction with suction pads. Neutral gases in accordance with EN 983 are approved as evacuation media. Neutral gases include air, nitrogen and inert gases (e.g. argon, helium and neon). Aggressive gases or media such as acids, acid fumes, bases, biocides, disinfectants or detergents are not permitted.



The ejector is **not** suitable for transporting or sucking through liquids or bulk material such as granulates.
Personal injury or damage to the ejector may occur.



The ejector must **not** be used to fill pressurized containers or to drive cylinders, valves or other pressure-operated functional components.
Personal injury or damage to the ejector may occur.

INSTALLATION AND OPERATION

For safe installation and trouble-free operation, please observe and comply with the following points:



The ejector may only be operated using power supply units with protected extra-low voltage (PELV). The system must incorporate safe electrical cut-off of the power supply in compliance with EN60204.



**Do not operate the ejector in environments where there is a risk of explosion.
Risk of fire and explosion.**



Output signals (discrete signals as well as IO-Link signals) can change when the power supply is switched on or the M12 connectors are plugged in. Depending on the function of the machine/system, this can result in serious personal injury or damage to the equipment.



The device may not be operated outside its specified performance limits. Doing so may cause it to malfunction or be destroyed.



During installation and maintenance, make sure that the ejector is disconnected and depressurized and that it cannot be switched on again without authorization. Personal injury or damage to the ejector may occur.

- Protect the ejector from damage at all times.
- No modifications may be made to the ejector.
- Opening the covers on the side will damage the “tested” labels. This voids the warranty.
- Connection symbols and labels are located on the ejector. These must be observed.
- Only the intended connections may be used.
- Pneumatic and electrical line connections must be securely connected and attached to the ejector.
- The ejector may be installed in any position.
- If these instructions are not observed, malfunctions, material damage and serious injury – including fatal injury – may result.
- If the ejector is no longer operative, the components must be disposed of in an ecologically sound manner.

2 PRODUCT OVERVIEW

GENERAL DESCRIPTION OF FUNCTIONS

VACUUM GENERATION (PICKING UP THE WORKPIECE)

The ejector is designed for vacuum handling of parts in combination with suction systems. The Venturi nozzle is activated and deactivated via the suction signal input. In the NO version, the Venturi nozzle is deactivated when the suction input signal is present. In the NC version, the Venturi nozzle is activated when the suction input signal is present. In the IMP version, the suction signal input is evaluated according to a pulse. This means that the ejector goes into suction mode when a pulse with a duration of at least 50 ms is present. A longer pulse does not affect the function.

An integrated sensor records the vacuum generated by the Venturi nozzle. This is evaluated by an electronics system and serves as the basis for displaying the system states and for switching the outputs.

The ejector has an integrated air-saving function. The ejector automatically regulates the vacuum while in suction mode. The electronics system switches the Venturi nozzle off when the switching point H1 set by the user is reached.



If small volumes are to be evacuated, the set switching point H1 might be exceeded considerably before the vacuum is switched off. This system behavior does not constitute an error.

When objects with dense surfaces are picked up, the integrated non-return valve prevents the vacuum from dropping. If leakage causes the system vacuum to drop below the switching point H1-h1, the Venturi nozzle is switched on again.

For ejectors with a pulse valve (IMP), the ejector remains in suction mode if the power supply fails during automatic mode. This prevents objects that have been picked up from falling off the suction pad in the event of a power supply failure. This also applies when the ejector was in the “Venturi nozzle inactive” state with the air-saving function activated. In this case, the ejector switches to “Venturi nozzle active,” i.e., to continuous suction. When the power supply returns, the ejector remains in automatic mode with the air-saving function activated. If the ejector is in blow-off mode when the power supply fails, the blow-off is stopped and the ejector is set to “pneumatically OFF”. This prevents unnecessary consumption of compressed air, thus saving energy and additional costs. When the power supply returns, the ejector remains in “pneumatically OFF” mode.

The supply voltage is monitored by the electronics system. If the supply voltage falls below approx. 19.2 V, this is indicated by an error message. It cannot be ensured that the ejector will operate as intended below this voltage threshold.

For NO and NC ejectors, the suction valve is also equipped with a button for manual operation. This can be used to actuate the valve manually without a power supply.

BLOW-OFF (DEPOSITING THE WORKPIECE)

In blow-off mode, the vacuum circuit of the ejector is supplied with compressed air. This ensures that the vacuum drops quickly, depositing the workpiece quickly as well. Blow-off mode can be controlled externally or internally.

When controlled externally, blow-off mode is activated by the “blow-off” signal input.

When controlled internally (automatic blow-off), the blow-off valve is actuated for a defined period after suction mode is exited. This function is not available in the IMP ejector version.

For pulse-controlled ejectors (IMP version), the suction input signal is not evaluated if it is still present following blow-off mode. The ejector does not switch to suction mode until another pulse is received.

The blow-off valve is also equipped with a button for manual operation. The manual operation button can be used to set the ejector to blow-off mode without a power supply.



The ejector must not be operated with a sealed vacuum connection. Personal injury or damage to the ejector may occur.



The ejector also has a manual mode. In this mode, the ejector can be controlled using the buttons on the ejector's foil keypad. See the “Manual mode” section for more details.

VACUUM/PRESSURE DISPLAY

The current system vacuum is always displayed in the 3-digit display. Pressing the  button while the ejector is in display mode briefly displays the current units.

The 2 LEDs below the display indicate which range the vacuum level is in relative to the set threshold values.

For versions with an integrated pressure sensor, pressing the  button displays the current system pressure in the display instead of the current system vacuum.

IO-LINK

The ejector can be operated in IO-Link mode to enable parameterization and intelligent communication with a controller.

This provides the user with a range of diagnostic and monitoring functions.

VERSIONS

Each ejector has a specific item designation (e.g. SXMPi-20-NO-H-2xM12).

The item designation can be broken down as follows:

Type	Performance class	Idle position	Pneumatic connection	Additional function	Electrical connection
SXPi	15	NO	H Horizontal	PC	M12
SXMPi (M = with power blow-off module)	20 25 30	Normally open NC Normally closed IMP Bistable via pulse	Q Quick change	Pressure control	1xM12, 8-pin 2xM12 2xM12, 5-pin

The ejector system consists of a basic module and various expansion modules. The most important components are described below.

EJECTOR VERSION PNP OR NPN

The behavior of the ejector's electrical inputs and outputs can be adjusted on the device and therefore does not depend on the version.

The ejectors are factory set to PNP.

ADDITIONAL FUNCTION PC

The **PC** option can be ordered for all ejector types. In this version, an additional pressure sensor is integrated into the ejector.

This provides the following additional functions:

- Pressure shown on display
- Signal output for pressure monitoring (freely adjustable)

Additional via IO-Link:

- Current pressure value
- Advanced condition monitoring with
 - Leakage measurement
 - Dynamic pressure measurement
 - Performance calculation
 - Quality assessment
- Advanced energy monitoring with
 - Absolute air consumption measurement
 - Energy consumption measurement

ELECTRICAL CONNECTION

The electrical connection comes in two designs: one M12 connector with 8 pins or two M12 connectors with 5 pins each.

Both versions have three signal inputs and three signal outputs as well as pins for the supply voltage. For the design with one 8-pin plug, the entire ejector is supplied with only one voltage. The design with two 5-pin plugs, in contrast, requires two voltages to supply the sensors and the actuators of the ejector separately.

Version	Block wiring diagram	Description
<p>M12</p>		<p>Sensors and valves (actuators) of the ejector are supplied by a single voltage (V_{SA})</p>
<p>2xM12</p>		<p>Sensors and valves supplied separately from two voltages (V_S and V_A) Galvanic isolation of the voltage circuits</p>

EJECTOR DESIGN

BASIC MODEL

The basic model of the ejector is designed as follows:

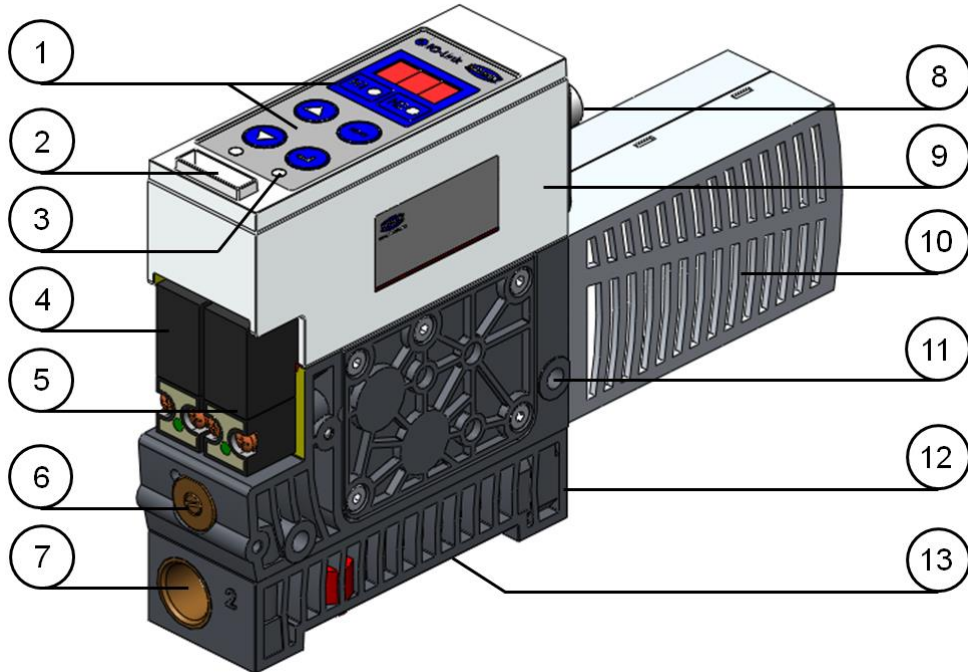

Only screw unions with cylindrical G-threads can be used at pos. 7 and pos. 12.

Position	Description	Max. tightening torque
1	Operating and display elements	
2	Status indicator	
3	Valve status indicator	
4	Blow-off pilot valve – NC	0,5 Nm
5	Suction pilot valve – NO, NC or IMP (depending on version)	0,5 Nm
6	Valve screw for blow-off volume flow	
7	G3/8" vacuum connection (label: 2 [V])	10 Nm
8	M12 electrical connection	handfest
9	Controller	0,5 Nm
10	Silencer	
11	Mounting holes	4 Nm
12	Compressed air connection G3/8" in H version (label: 1 [P])	10 Nm
13	2x M5 mounting threads	3 Nm

EXPANSION MODULES

The basic module can be modified and expanded using a variety of expansion modules.

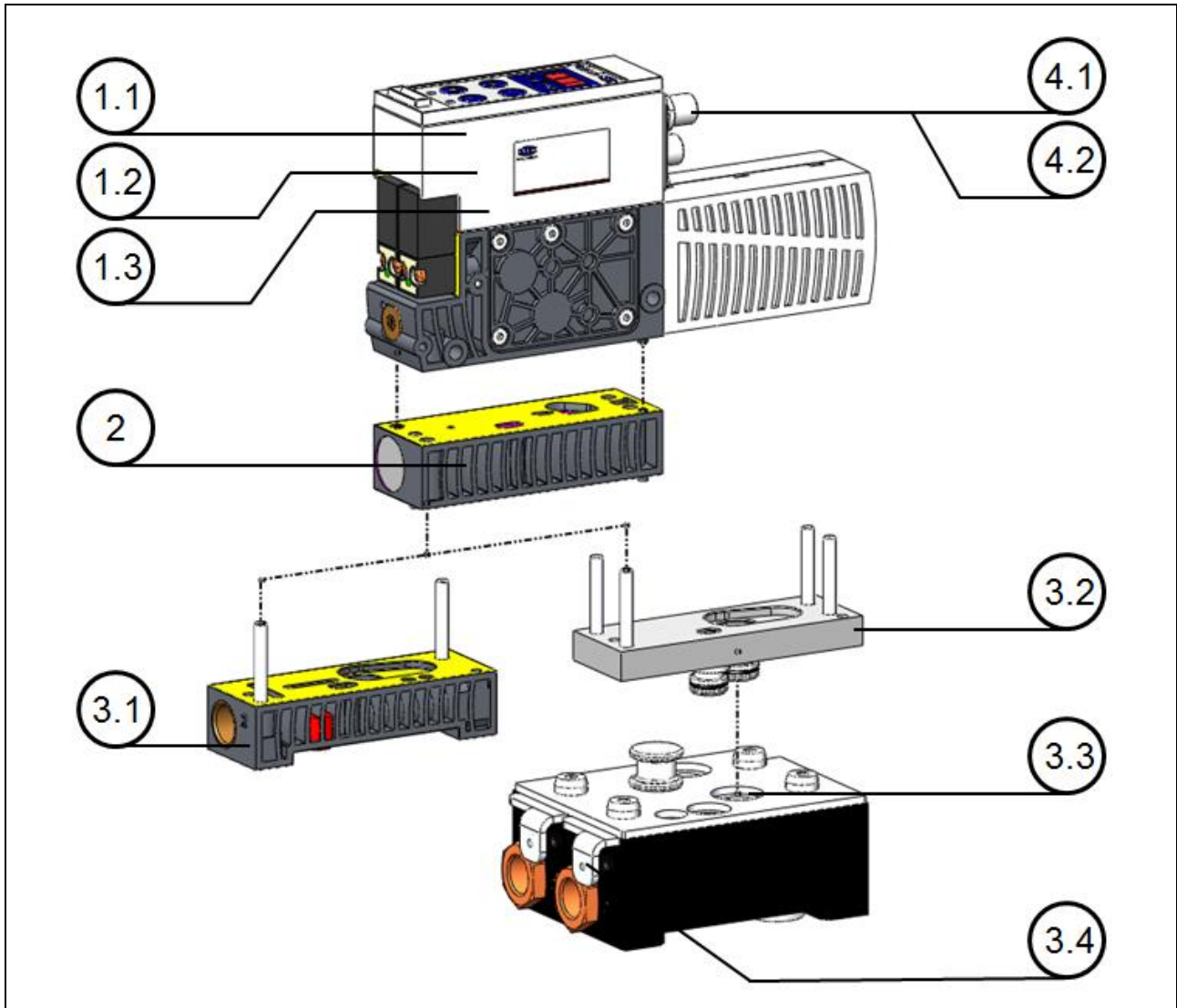

Position	Description
1.1	Basic module – NO suction valve...normally open
1.2	Basic module – NC suction valve...normally closed
1.3	Basic module – IMP suction valve...bistable via pulse
2	Power blow-off module SXMP
3.1	Horizontal pneumatic connection (1[P]= G3/8", 2[V]= G3/8")
3.2	Quick-change pneumatic connection
3.3	Quick-change double block
3.4	Quick-change release lever
4.1	Electrical connection, 2x M12, 5-pin
4.2	Electrical connection, 1x M12, 8-pin

OPERATING AND DISPLAY ELEMENTS

The foil keypad with a three-digit display, a status indicator and 4 additional LEDs allows for very simple operation of the ejector.

	Position	Description
	1	Display
	2	LEDs for threshold values H1/H2
	3	MENU button
	4	ENTER button
	5	UP button
	6	DOWN button
	7	Suction valve LED
	8	Blow-off valve LED
	9	Status indicator



VALVE LEDs

The suction and blow-off valves are each assigned an LED.

Valve LEDs		Ejector status
	LEDs are both off	NO: Suction on ejector NC: No suction on ejector IMP: No suction on ejector
	Suction LED is continuously lit	NO: No suction on ejector NC: Suction on ejector IMP: Suction on ejector
	Blow-off LED is continuously lit	NC: Ejector blows off IMP: Ejector blows off
	LEDs are both continuously lit	NO: Ejector blows off

STATUS INDICATOR FOR SYSTEM VACUUM

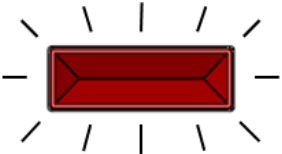
During conventional suction cycles, the status indicator shows the current level of the system vacuum relative to the switching points H1 and H2. The status indicator goes out after a conventional suction cycle is finished.



Status indicator		Vacuum level
	RED	Rising vacuum: Vacuum < H2 Falling vacuum: Vacuum < (H2-h2)
	Flashing RED	Rising vacuum: Vacuum > H2 and < H1 Falling vacuum: Vacuum > (H2-h2) and < (H1-h1)
	GREEN	Rising vacuum: Vacuum > H1 Falling vacuum: Vacuum > (H1-h1)



If the condition monitoring function is active, different statuses are assigned to the status indicator.

LEDs FOR THRESHOLD VALUES H1/H2

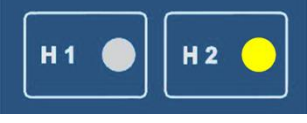
The LEDs for the H1 and H2 threshold values indicate the current level of the system vacuum relative to the configured switching points. Their display behavior does not depend on the switch functions or assignment of the outputs (H1/HP1), nor does it depend on whether the condition monitoring function is active.

Threshold value LEDs		Ejector status
	LEDs are both off	Rising vacuum: Vacuum < H2 Falling vacuum: Vacuum < (H2-h2)
	H2 LED is continuously lit	Rising vacuum: Vacuum > H2 and < H1 Falling vacuum: Vacuum > (H2-h2) and < (H1-h1)
	LEDs are both continuously lit	Rising vacuum: Vacuum > H1 Falling vacuum: Vacuum > (H1-h1)

3 DESCRIPTION OF FUNCTIONS

OPERATING MODES

The ejectors are differentiated according to their start position when in the idle state: NO (normally open), NC (normally closed) and IMP (impulse).

When the ejector is connected to the power supply, the ejector is in automatic mode and ready for operation. This is the normal operating mode, in which the ejector is operated by the system controller. A differentiation is made between SIO mode and IO-Link mode.

In addition to automatic mode, you can also change the operating mode of the ejector to manual mode using the buttons on the foil keypad.

Parameterization of the ejector is always performed in automatic mode.

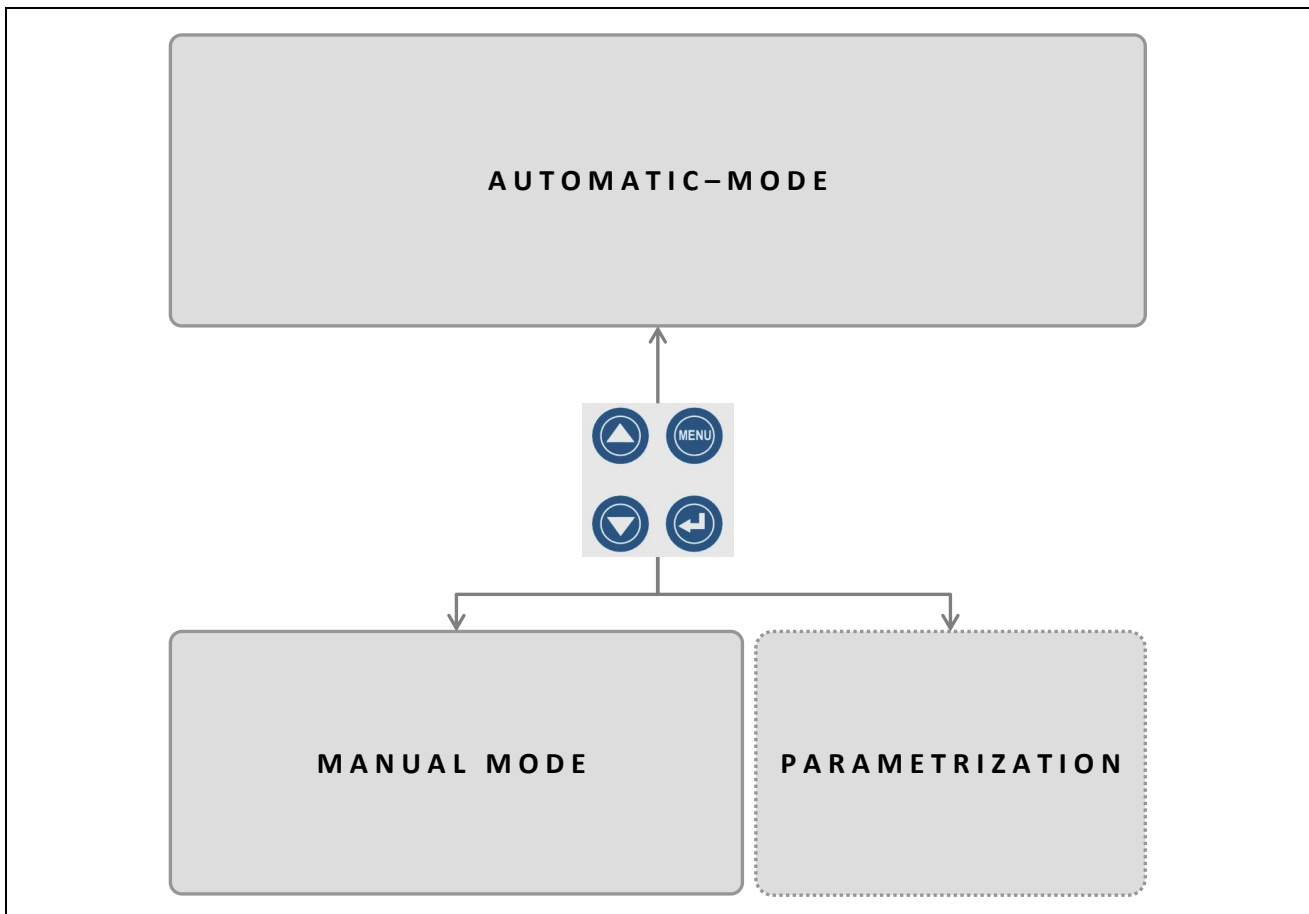

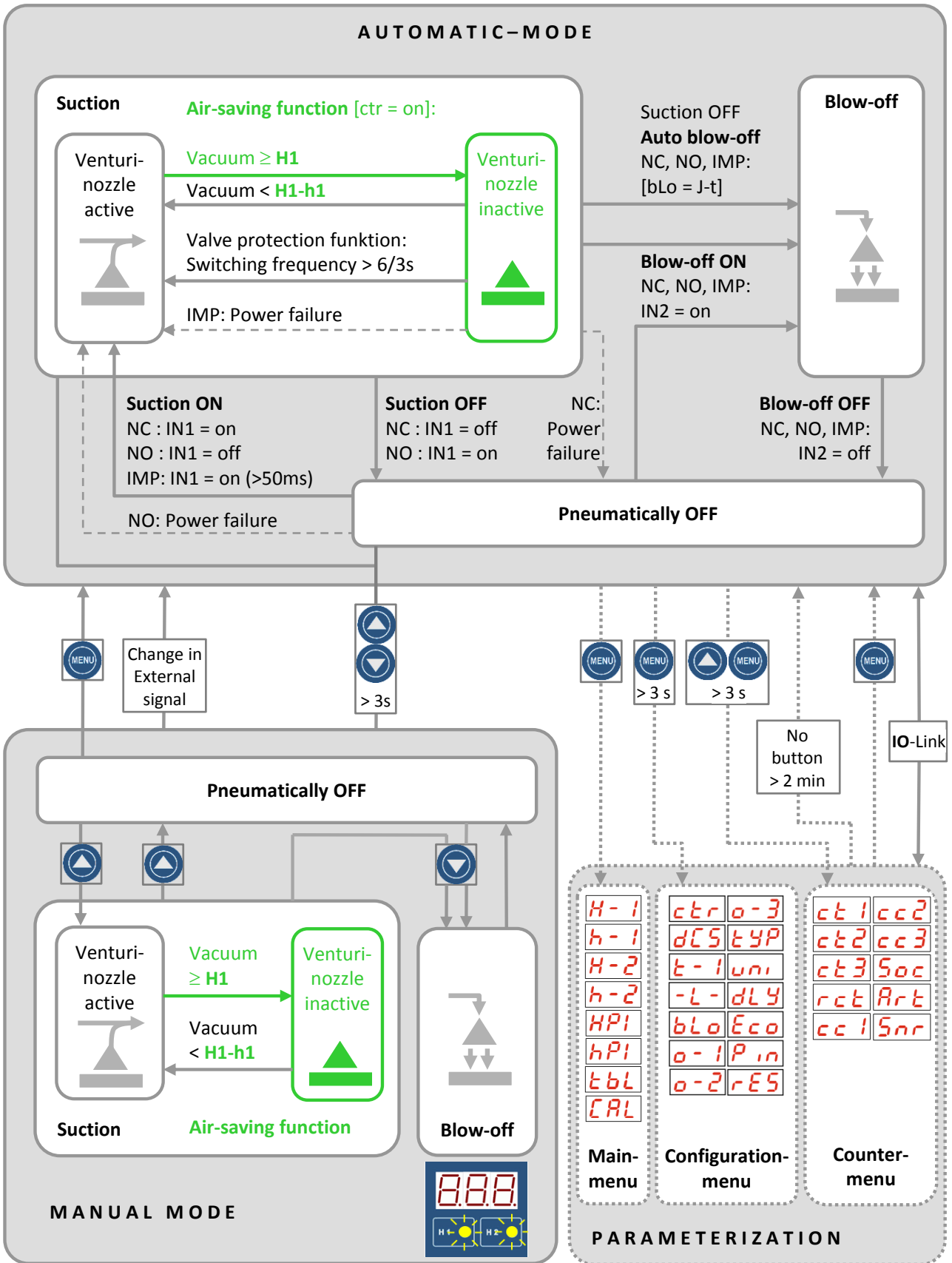

CONTROL CONCEPT FOR NO EJECTORS

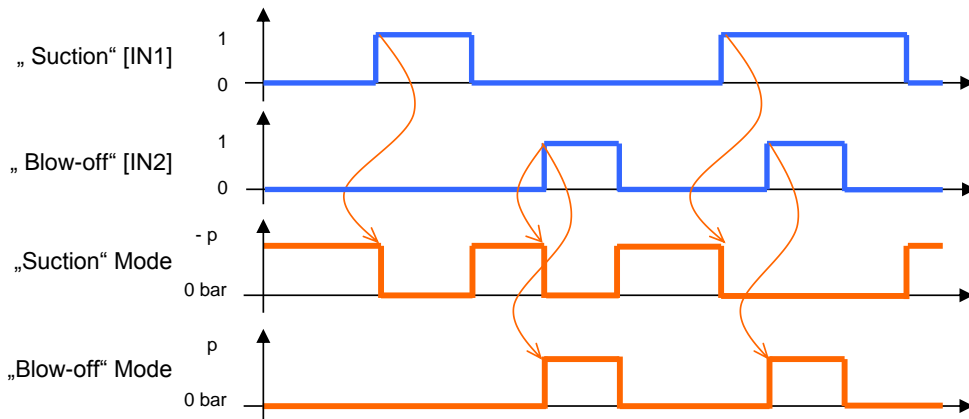

CONTROL CONCEPT FOR NC EJECTORS

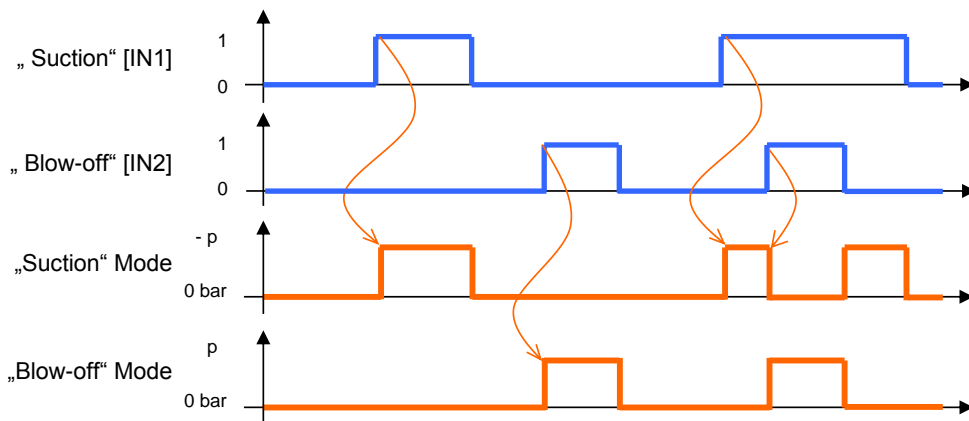

CONTROL CONCEPT FOR IMP EJECTORS

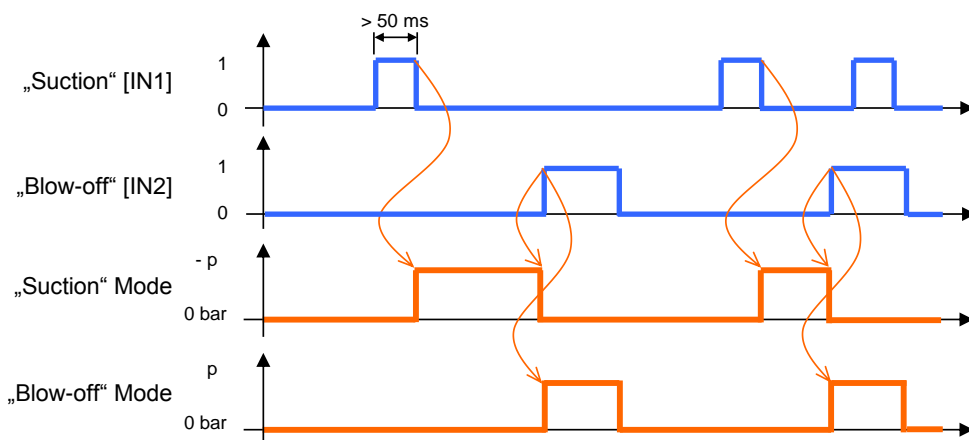

IMP ejectors are set to “pneumatically OFF” on delivery. The ejector only begins suction after a valid pulse is received via the suction signal input.

GENERAL FUNCTIONS

MANUAL MODE



The output signals may change during set-up in manual mode. Ensure that the machine or system does not start moving as a result. Personal injury or damage to the ejector could result.



Starting manual mode always switches the ejector to “pneumatically OFF” mode. In other words, starting manual mode interrupts an active suction process. Danger due to falling parts.

In manual mode, the pick-up and blow-off ejector functions can be controlled independently of the higher-level controller using the buttons on the operating panel.

In this operating mode, the H1 and H2 LEDs both flash.



Because the valve protection function is deactivated in manual mode, this function can be used to locate and rectify leaks in the vacuum circuit.

ACTIVATING MANUAL MODE

Activate manual mode as follows:

- Press and hold the  and  buttons together for more than 3 seconds.

MANUAL SUCTION

In manual mode, suction is activated by pressing the  button. Exit suction mode by pressing the  button again or by pressing the  button.



If the air-saving function is activated ([ctr=on] or [ctr=ONS]), this is also activated in manual mode.



The valve protection function is not active in manual mode.

MANUAL BLOW-OFF

Blow-off mode is activated in manual mode by pressing the  button. This mode remains active as long as the button is pressed.

DEACTIVATING MANUAL MODE

Exit manual mode while in the “pneumatically OFF” idle position using the  button.

The ejector also exits manual mode when the statuses of the external signal inputs change.



This automatic exiting of manual mode due to changes in external signals can cause the object being handled to move (due to suction or blow-off).

SET-UP MODE

Similar to manual mode, set-up mode can be used to locate and rectify leaks in the vacuum circuit because the valve protection function is deactivated and because the control function is not deactivated even if the control frequency increases.

In this operating mode, the H1 and H2 LEDs both flash.

Set-up mode is switched on and off via bit 2 in the process data byte output (PDO). A change to bit 0 or bit 1 (suction or blow-off) in the PDO also causes the ejector to exit set-up mode.



This function is only available in IO-Link mode.

MONITORING THE SYSTEM VACUUM

Every ejector has an integrated sensor for monitoring the current system vacuum. The vacuum level provides information on the process and has an effect on the following signals and parameters:

- Threshold value LED H1
- Threshold value LED H2
- Signal output H1 (only in versions with a pressure sensor)
- Signal output H2
- Vacuum analog value
- Process data bits H1
- Process data bits H2

The threshold values and the corresponding hysteresis values can be set under the menu items **[H-1]**, **[h-1]**, **[H-2]** and **[h-2]** or via IO-Link.

MONITORING THE SYSTEM PRESSURE

Ejectors with an integrated pressure sensor (SX(M)Pi – xx – xx – PC) monitor the system pressure in addition to the system vacuum. The pressure level affects the following signals and parameters:

- Signal output H1
- Pressure analog value
- Process data bits HP1

The threshold value HP1 and the corresponding hysteresis value can be set in the main menu under the menu items **[HP1]** and **[hP1]** or via IO-Link.

ZERO-POINT ADJUSTMENT OF THE SENSORS (CALIBRATION)

Because the internal sensors are subject to variations based on the manufacturing process, it is recommended to calibrate the sensors once the ejector is installed.

The vacuum circuit of the system must be ventilated to ambient pressure before a zero-point adjustment can be made to the vacuum sensor.

The pressure circuit of the system must be ventilated to ambient pressure before a zero-point adjustment can be made to the pressure sensor.



The zero point can only be shifted within a range of $\pm 3\%$ from the end value of the measurement range.



If the permissible limit of $\pm 3\%$ is exceeded, the **[E3]** error code is shown in the display.

The function for zero-point adjustment of the sensors can be carried out in the main menu under the menu items **[CAL]/[UAC]** (vacuum sensor) and **[CAL]/[PrS]** (pressure sensor) or via IO-Link.

CONTROL FUNCTION

This ejector function allows you to conserve compressed air. Vacuum generation is interrupted once the configured threshold value H1 is reached. If leakage causes the vacuum to fall below the hysteresis threshold H1-h1, vacuum generation resumes.

The following operating modes can be set for the control function in the configuration menu under the **[ctr]** menu item or via IO-Link.

No CONTROL (CONTINUOUS SUCTION)

The ejector produces continuous suction with maximum power. This setting is recommended for very porous workpieces, which would otherwise cause the vacuum generator to switch on and off continually due to the high rate of leakage.

The control function setting for this operating mode is **[oFF]**.



This setting (**[ctr = oFF]**) is only possible when control shutoff is deactivated **[dCS = NO]**.

CONTROL

The ejector switches off the vacuum generator when the threshold H1 is reached and switches it back on when the vacuum falls below the threshold H1-h1. This setting is particularly recommended for suction-tight workpieces.

The control function setting for this operating mode is **[on]**.

CONTROL WITH LEAK MONITORING

This operating mode is the same as the previous mode, with the addition that the leakage rate within the system is measured and compared to the configurable limit value **[-L-]**. If the actual leakage rate exceeds the limit value more than twice in succession, the control function is deactivated and the ejector switches to continuous suction.

The control function setting for this operating mode is **[onS]**.



Activating the **[onS]** function also enables configuration of the limit value **[-L-]** in the configuration menu.

CONTROL SHUTOFF

With this function, the automatic control shutoff caused by condition monitoring functions can be deactivated.

The function can be set in the configuration menu under the **[dCS]** menu item or via IO-Link.

If the function **[dCS = NO]** is selected, the ejector switches to continuous suction mode if the leakage rate and the valve switching frequency are too high.

With the **[dCS = YES]** setting, continuous suction is deactivated and the ejector continues in control mode despite high leakage and a control frequency greater than 6/3 s.



Deactivating the control shutoff function (**[dCS = YES]**) can lead to very frequent switching of the suction valve. This can destroy the ejector.



The setting **[dCS = YES]** is only possible when the control function **[ctr = on]** or **[ctr = onS]** is set.



In cases of undervoltage or power failure, the ejector switches to continuous suction according to the particular ejector version (NO/NC/IMP), even if continuous suction was deactivated with the **[dCS = YES]** setting.

BLOW-OFF MODES

This function is used to switch among the three blow-off modes.

The function can be set in the configuration menu under the **[bLo]** menu item or via IO-Link.

EXTERNALLY CONTROLLED BLOW-OFF

The blow-off valve is controlled directly via the blow-off signal input. The ejector switches to blow-off mode for as long as the signal is present.

The blow-off function setting for this operating mode is **[-E-]**.

INTERNALLY TIME-CONTROLLED BLOW-OFF

The blow-off valve is controlled automatically for the time period **[tbL]** after the ejector exits suction mode. This function makes it possible to save an output on the controller.

The blow-off function setting for this operating mode is **[I-t]**.

EXTERNALLY TIME-CONTROLLED BLOW-OFF

The blow-off pulse is controlled externally via the blow-off input. The blow-off valve is controlled for the configured time **[tbL]**. A longer input signal does not increase the blow-off duration.

The blow-off function setting for this operating mode is **[E-t]**.



The length of the blow-off time **[tbL]** is set in the main menu. This menu item is hidden in the **[-E-]** operating mode.



The **[I-t]** function is not available on ejectors with pulse valves.
The blow-off signal input is not evaluated if the **[I-t]** function is activated.



The number displayed indicates the blow-off time in seconds. Blow-off times from 0.10 s to 9.99 s can be set.

SIGNAL OUTPUTS

The ejector has three signal outputs. The signal outputs can be configured using the corresponding menu items.

OUTPUT FUNCTION

The signal outputs can be switched between **[no]** (normally open contact) and **[nc]** (normally closed contact).

The three signal outputs can be switched independently using the menu items **[o-1]**, **[o-2]** and **[o-3]** in the configuration menu, or via IO-Link.

OUTPUT TYPE

The output type can be used to switch the signal outputs between PNP and NPN. All three signal outputs are switched together. The signal inputs are also configured with this function.

The outputs/inputs can be switched using the **[tYP]** menu item in the configuration menu, or via IO-Link.

FUNCTION ASSIGNMENTS OF THE SIGNAL OUTPUTS

Output	Assigned function	
OUT 1	SX(M)Pi – xx	SX(M)Pi – xx – PC
	Switching threshold H1/h1	Switching threshold HP1/hp1
OUT 2	Switching threshold H2/h2 (part present control)	
OUT 3	Diagnostics (condition monitoring functions)	

The signal outputs OUT 1 and OUT 2 are switched on/off when the system vacuum/system pressure exceeds/falls below the particular threshold values.

The diagnostics output OUT 3 is activated by condition monitoring functions and remains so until the next suction cycle begins.



If the diagnostics/analysis function (DAF) is active, different functions are assigned to the signal outputs.

SELECTING THE VACUUM AND PRESSURE UNITS

This function can be used to select the units for the displayed vacuum and pressure values from the following three units.

The function can be set in the configuration menu under the **[uni]** menu item or via IO-Link.

BAR

The vacuum values are displayed in mbar, the pressure values are displayed in bar.

The setting for these units is **[-bA]**.

PASCAL

The vacuum values are displayed in kPa, the pressure values are displayed in MPa.

The setting for these units is **[-PA]**.

INCH OF HG

The vacuum and pressure values are displayed in inHg.

The setting for this unit is **[-iH]**.



The pressure display is only available on ejectors with a pressure sensor (SX(M)Pi – xx – PC – xx).

SWITCH-OFF DELAY FOR THE SIGNAL OUTPUTS

This function is used to set the switch-off delay for the signal outputs. This function sets a delay before the ejector's signal outputs OUT1 and OUT2 are switched off. This can be used to hide short drops in the pressure or vacuum circuit.

The length of the switch-off delay is set for both outputs together via the **[dIY]** menu item in the configuration menu or via IO-Link. Values of 10, 50 or 200 ms can be selected; a value of 0 (= off) must be set to deactivate this function.

ECO MODE

The ejector offers the option to switch off the display to save energy. If eco mode is activated, the display is switched off and the power consumption is reduced after 2 minutes if no buttons are pressed.

A red dot in the lower right corner of the display indicates that the display has been switched off. The display can be reactivated by pressing any button. The display is also reactivated by an error message.

ECO mode can be activated and deactivated in the configuration menu under the **[Eco]** menu item or via IO-Link.

PIN FOR WRITE PROTECTION

A PIN can be used to secure write access for all parameters. The current settings are still displayed.

The PIN is set to 000 on delivery, meaning access to the parameters is not locked. A valid PIN between 001 and 999 must be entered in order to activate the write protection.

If write protection is activated with a customer-specific PIN, the desired parameters can be changed within two minutes after the correct code is entered. If no changes are made within two minutes, write protection is automatically reactivated. A PIN of 000 must be set to permanently deactivate the lock.

Full access is still possible via IO-Link even if a PIN is enabled. The current PIN can also be read out and changed/deleted (PIN = 000) via IO-Link.

The PIN is entered in the configuration menu under the menu item **[PIN]** or via IO-Link.



A PIN is recommended because carrying out parameterization while the ejector is in operation can change the status of signal inputs and outputs.

RESET TO FACTORY SETTINGS

This function is used to reset the ejector to its factory settings.

All switching points and configurations are reset to the factory settings. This function does not affect counter readings or zero-point adjustments to the sensors.

The function is carried out in the configuration menu under the **[rES]** menu item or via IO-Link.



The factory settings of the ejector can be found in the appendix.



Resetting the factory settings changes the switching points and configuration of the signal output. This can change the status of the ejector system.

COUNTERS

The ejector is equipped with six internal counters. The counters always count up in pairs, in which one counter can be deleted and the other cannot.

In addition to the total counters **[cc1]**, **[cc2]** and **[cc3]**, which continue to count throughout the service life of the ejector, the temporary counter readings **[ct1]**, **[ct2]** and **[ct3]** can also be read out.

Counter 1 is increased with each valid pulse at the suction signal input and therefore counts the number of suction cycles in automatic mode. Counter 2 is increased with each switch of the suction valve. The switching frequency of the air-saving function can then be determined from the difference between counters 1 and 2. Counter 3 measures all condition monitoring events that occur (counter 3 is also increased when the diagnostics output is activated).

Symbol	Function	Description
[cc1] / [ct1]	Counter 1	Counter for suction cycles (suction signal input)
[cc2] / [ct2]	Counter 2	Counter for valve switching frequency
[cc3] / [ct3]	Counter 3	Condition monitoring counter

The counters are read out in the system menu; the temporary counters can be deleted using the **[rct]** menu item. The counters can also be read out and deleted via IO-Link.

POWER FAILURE

All ejector types have an internal voltage monitor. If the supply voltage drops below the permitted threshold, the status of the ejector changes as follows:

NO EJECTOR TYPE

The ejector switches to suction mode

NC EJECTOR TYPE

The ejector switches to “pneumatically OFF” mode

IMP EJECTOR TYPE

The ejector remains in the current operating mode, i.e., if suction is active (also when control is active), the ejector continues to supply suction; if the ejector was in “pneumatically OFF” mode, it remains in this mode.



The control function is canceled if the voltage drops while suction is active.

SETTING THE BLOW-OFF VOLUME FLOW

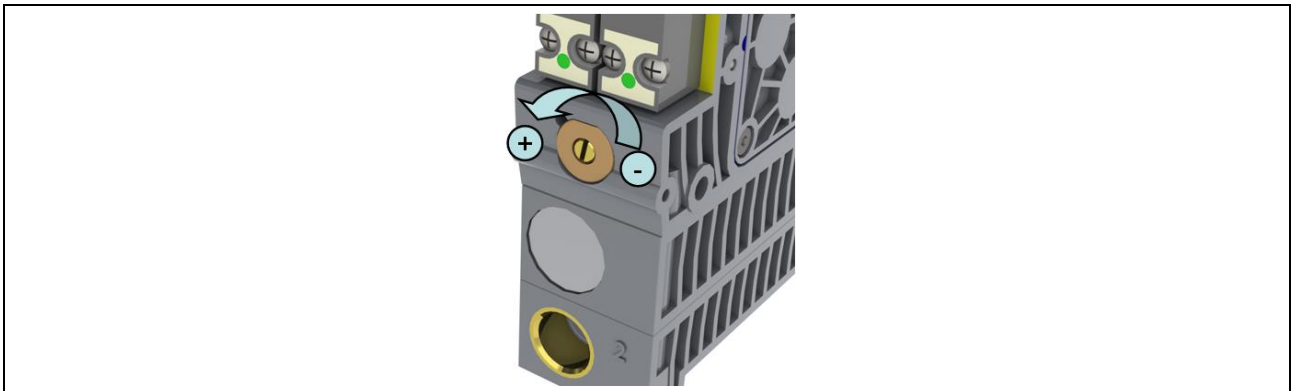

A valve screw is located underneath the pilot valve. This valve screw can be used to set the blow-off volume flow.

Turning the screw clockwise reduces the volume flow. Turning the screw counterclockwise increases the volume flow.

The valve screw is equipped with a stop on both sides.



Do not turn the valve screw past the stops. A minimum volume flow of approx. 20% is always necessary for technical reasons.

The blow-off volume flow can be set between 20% and 100%.

CONDITION MONITORING [CM]

MONITORING THE VALVE SWITCHING FREQUENCY

If the air-saving function is activated (**[ctr = on]** or **[ctr = onS]**) and the leakage rate in the gripper system is high, the ejector is constantly switching between the “Venturi nozzle active” and “Venturi nozzle inactive” states. The number of valve switching procedures thus increases rapidly within a short time. In order to protect the ejector and increase its service life, the ejector switches the air-saving function off automatically at a switching frequency of > 6/3 seconds and activates continuous suction (i.e., the ejector then remains in the “Venturi nozzle active” state).

- The diagnostics output OUT 3 is activated.
- The status indicator flashes green until the next suction cycle
- Bit 0 is activated in IO-Link parameter 0x0092 and a condition monitoring event is signaled by bit 6 in the process data input byte.



The setting **[dCS = YES]** prevents continuous suction from being activated.

MONITORING THE CONTROL THRESHOLD

This function is activated if switching point H1 is never reached during a suction cycle.

- The diagnostics output OUT 3 is activated.
- The status indicator flashes red until the next suction cycle
- Bit 3 is activated in IO-Link parameter 0x0092 and a condition monitoring event is signaled by bit 6 in the process data input byte.

MONITORING THE EVACUATION TIME

This function is activated if the measured evacuation time t_1 (from H2 to H1) exceeds the set value **[t-1]**.

- The diagnostics output OUT 3 is activated.
- The status indicator flashes red until the next suction cycle
- Bit 1 is activated in IO-Link parameter 0x0092 and a condition monitoring event is signaled by bit 6 in the process data input byte.

To deactivate this function, a value of 0 (= off) must be set for the permitted evacuation time. The maximum permitted evacuation time that can be set is 9.99 s.

The set value for the max. permitted evacuation time can be set in the configuration menu under the **[t-1]** menu item or via IO-Link.

MONITORING LEAKAGE

In control mode ($[-L-] = \text{onS}$), the drop in the vacuum level within a certain time is monitored (mbar/s). A distinction is made between two states.

Leakage $L < [-L-]$	Leakage $L > [-L-]$
<p>If the leakage rate is less than the set value $[-L-]$ in mbar/s, the vacuum level continues to fall until the switching point $H1-h1$ and then the ejector resumes suction (normal control mode). The condition monitoring function is not activated.</p>	<p>If the leakage rate is greater than the value $[-L-]$, the ejector immediately reacts to correct the vacuum level. The condition monitoring function is activated if the leakage rate exceeds the limiting rate twice.</p> <ul style="list-style-type: none"> ▪ The ejector switches to continuous suction. ▪ The diagnostics output (OUT 3) is activated. ▪ The status indicator flashes green until the next suction cycle.
<p>The graph shows a vacuum level (y-axis) over time (x-axis). The vacuum level starts at H1, drops to H1-h1, and then recovers. The leakage rate is shown as a small slope below the setpoint $[-L-]$. The vacuum level continues to fall until the switching point $H1-h1$ and then the ejector resumes suction (normal control mode).</p>	<p>The graph shows a vacuum level (y-axis) over time (x-axis). The vacuum level starts at H1, drops to H1-h1, and then recovers. The leakage rate is shown as a steep slope above the setpoint $[-L-]$, indicating a high leakage rate. The ejector immediately reacts to correct the vacuum level.</p>

When the condition monitoring function is active, bit 2 is activated in IO-Link parameter 0x0092 and a condition monitoring event is signaled by bit 6 in the process data input byte. Monitoring takes place during every control cycle.

The set value for the max. permitted leakage rate can be set in the configuration menu under the $[-L-]$ menu item or via IO-Link. Values of 4, 11, 25, 50, 100, 150 or 250 mbar/s can be set.

MONITORING THE OPERATING PRESSURE

The internal pressure sensor continuously measures the system pressure of the ejector and compares it to the permitted operating pressure limits.

A warning message is issued when the pressure exceeds or falls below these limits.

- Bit 7 is activated in IO-Link parameter 0x0092 and a condition monitoring event is signaled by bit 6 in the process data input byte.

MONITORING THE DYNAMIC PRESSURE

The dynamic pressure is measured at the beginning of every suction cycle. The result of the measurement is compared to the set threshold values $H1$ and $H2$.

If the dynamic pressure is greater than $(H2 - h2)$ but less than $H1$, a warning message is issued.

- Bit 4 is activated in IO-Link parameter 0x0092 and a condition monitoring event is signaled by bit 6 in the process data input byte.



The two condition monitoring functions for operating pressure and dynamic pressure have no effect on the status indicator and the diagnostics output. This information is only transmitted via IO-Link.



The two condition monitoring functions for operating pressure and dynamic pressure are only available in ejectors with an integrated pressure sensor (SX(M)Pi – xx – PC).

DIAGNOSTICS OUTPUT

The diagnostics output OUT 3 is activated by one of the following four condition monitoring functions:

- Monitoring of the control threshold
- Monitoring of the evacuation time
- Monitoring of leakage
- Monitoring of the valve switching frequency

The diagnostics output then remains active until the beginning of the next suction cycle.

STATUS INDICATOR WHEN A CONDITION MONITORING FUNCTION IS ACTIVE

If a condition monitoring function is active, the status indicator provides the following information.

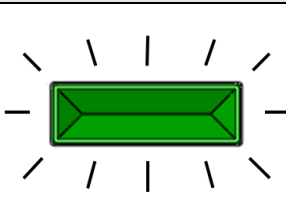
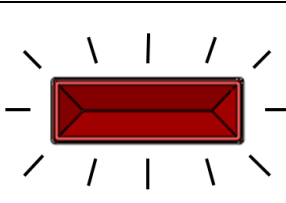
Status indicator		Condition monitoring function	Ejector reaction
	Flashing GREEN	Leakage (greater than -L-)	Continuous suction
		Valve switching frequency (greater than 6/3 s)	Continuous suction
	Flashing RED	Control threshold (H1 not reached)	-
		Evacuation time (t-1 exceeded)	-

If the vacuum level falls below the threshold values $H1$ and/or $H2$ while the suction cycle is still active, the status indicator provides information on the current vacuum level as described in the overview on monitoring the system vacuum using the status indicator.

The result of the condition monitoring function is displayed after the suction cycle ends. This remains until the next suction cycle begins.

EXAMPLES FOR THE STATUS INDICATOR

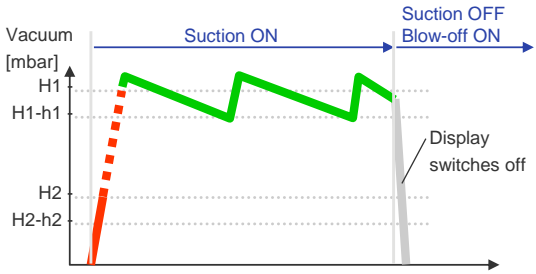
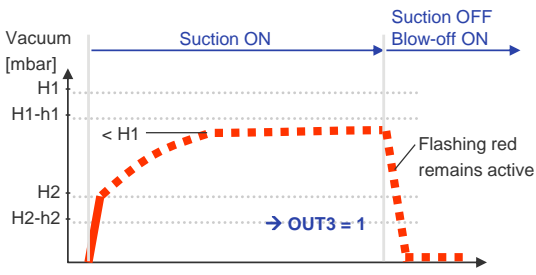
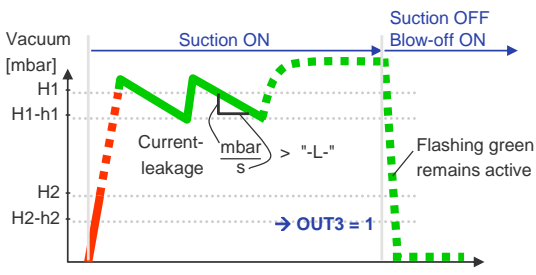
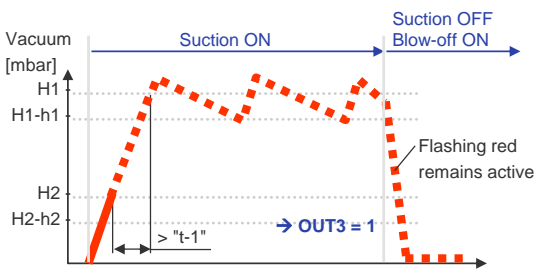
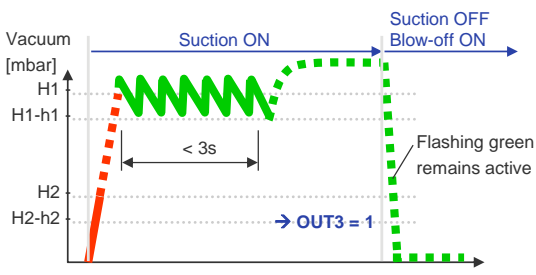
System mode	Status indicator	Description
Normal mode	 <p>Vacuum [mbar] vs. Time. Suction ON (blue arrow), Suction OFF Blow-off ON (blue arrow). Vacuum levels: H1, H1-h1, H2, H2-h2. Display switches off.</p>	<p>Status indicator shows the level of the system vacuum</p>
CM function control threshold	 <p>Vacuum [mbar] vs. Time. Suction ON, Suction OFF Blow-off ON. Vacuum levels: H1, H1-h1, H2, H2-h2. $< H1$, $\rightarrow OUT3 = 1$, Flashing red remains active.</p>	<ul style="list-style-type: none"> ▪ Flashing red ▪ OUT 3
CM function leakage	 <p>Vacuum [mbar] vs. Time. Suction ON, Suction OFF Blow-off ON. Vacuum levels: H1, H1-h1, H2, H2-h2. Current-leakage $\frac{mbar}{s} > ".L."$, $\rightarrow OUT3 = 1$, Flashing green remains active.</p>	<ul style="list-style-type: none"> ▪ Control shutoff ▪ Flashing green ▪ OUT 3
CM function evacuation time	 <p>Vacuum [mbar] vs. Time. Suction ON, Suction OFF Blow-off ON. Vacuum levels: H1, H1-h1, H2, H2-h2. $> "t-1"$, $\rightarrow OUT3 = 1$, Flashing red remains active.</p>	<ul style="list-style-type: none"> ▪ Flashing red ▪ OUT 3
CM function valve protection	 <p>Vacuum [mbar] vs. Time. Suction ON, Suction OFF Blow-off ON. Vacuum levels: H1, H1-h1, H2, H2-h2. $< 3s$, $\rightarrow OUT3 = 1$, Flashing green remains active.</p>	<ul style="list-style-type: none"> ▪ Control shutoff ▪ Flashing green ▪ OUT 3

DIAGNOSTICS/ANALYSIS FUNCTION

The SXPi/SXMPi measures the leakage rate in the vacuum system during every suction cycle. The ejector measures the drop in the vacuum per unit of time. This function is a unique tool for evaluating the leak-tightness of the entire system. The measured leakage value falls within one of four leakage ranges (see table).



With the aid of the X-Pump's "DAF" signal input **IN3**, the result can be displayed via the outputs **OUT1** and **OUT3**. The average of the leakage measurements from the last 16 cycles is always used.

CONDITIONS FOR A LEAKAGE MEASUREMENT

- The leakage measurement is performed automatically during every complete suction cycle.
- If the switching threshold **H1** is not reached, a leakage measurement cannot be performed and the system is deemed insufficiently leak-tight.
- If the hysteresis value of the air-saving function (**h1**) is set to a value < 22 mbar, the DAF is deactivated because a leakage measurement is not performed. (In this case the system state is deemed leak-tight.)

EVALUATING THE LEAKAGE MEASUREMENT VIA DAF

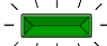
- A pulse with duration > 50 ms at the "DAF" signal input **IN3** starts the evaluation (only in the idle state).
- The signal outputs "DAF1" **OUT1** and "DAF2" **OUT3** are switched on or off according to the calculated average leakage (see the table). The current settings for the outputs (NO/NC) are disabled during the evaluation.
- The DAF status is shown via the diagnostics indicator.
- **[diA]** is shown in the display during the evaluation.
- The evaluation is ended when a new suction/blow-off process is started.

System state	Leakage	Diagnostics indicator		OUT1*	OUT3*
LEAK-TIGHT	< 67 mbar/s	GREEN		1	1
LOW LEAKAGE	67 to 133 mbar/s	FLASHING GREEN		1	0
HIGH LEAKAGE	133 to 200 mbar/s	FLASHING RED		0	1
INSUFFICIENTLY LEAK-TIGHT	> 200 mbar/s	RED		0	0



The four leakage ranges are determined according to fixed values that **cannot** be changed.



The functions described below have no effect on the status indicator or the outputs.

They are only for use via IO-Link

EVALUATION OF THE LEAKAGE RATE

Similar to the diagnostics/analysis function (DAF), this parameter outputs the range of the average leakage during the last suction cycle.

The value is provided via IO-Link at the beginning of the next suction cycle.

MEASUREMENT OF THE EVACUATION TIME t_0

This measures the time (in ms) from the beginning of a suction cycle, started by the command "Suction ON", until the switching threshold H2 is reached.

The value is provided via IO-Link at the beginning of the next suction cycle.

MEASUREMENT OF THE EVACUATION TIME t_1

This measures the time (in ms) from when the switching threshold H2 is reached until the switching threshold H1 is reached.

The value is provided via IO-Link at the beginning of the next suction cycle.

ENERGY MONITORING [EM]

The ejector offers functions for measuring and displaying the energy consumption to help further optimize the energy efficiency of vacuum gripper systems.



The values are determined from comparison tables according to current process parameters. Although the ejector is not a calibrated measuring device, the values can be used as a reference and for relative measurements.

PERCENTUAL AIR CONSUMPTION MEASUREMENT

All ejectors calculate the percentual air consumption of the last suction cycle. This value corresponds to the ratio of the active suction/blow-off times to the total duration of the suction cycle.

The value is provided via IO-Link at the beginning of the next suction cycle.

ABSOLUTE AIR CONSUMPTION MEASUREMENT

Ejectors with an integrated pressure sensor also offer an absolute air consumption measurement in addition to the percentual air consumption measurement.

The actual air consumption of a suction cycle is calculated by taking into account the system pressure and the nozzle size.

The value is provided via IO-Link at the beginning of the next suction cycle.

ENERGY CONSUMPTION MEASUREMENT

Ejectors with an integrated pressure sensor measure the electrical energy consumed during a suction cycle, including energy used for flushing the valves and while the ejector is idle.

The value is provided via IO-Link at the beginning of the next suction cycle.



The IO-Link parameter address can be found in the table in the “IO-Link mode” section

PREDICTIVE MAINTENANCE [PM]

MEASUREMENT OF THE LEAKAGE

This measures the leakage (drop in vacuum level per unit of time in mbar/s) after the control function has halted suction because the threshold value H1 was reached.

The value is provided via IO-Link at the beginning of the next suction cycle.

MEASUREMENT OF THE DYNAMIC PRESSURE

This measures the system vacuum achieved during unobstructed intake. The duration of the measurement is approx. 1 s. To perform a valid dynamic pressure value evaluation, it is therefore necessary to allow the ejector to suck in air unobstructed for at least 1 s after suction begins, i.e., the suction cell must not yet be covered by a component.

Measured values that are above the threshold value H1 are output as 0 mbar to indicate that a valid dynamic pressure measurement could not be performed.

Measured values that are greater than the threshold value (H2 – h2) but less than the threshold value H1 trigger a condition monitoring event.

The value is provided via IO-Link at the beginning of the next suction cycle.

QUALITY ASSESSMENT

To evaluate the entire gripper system, the ejector calculates a quality assessment value based on the measured leakage in the system.

The greater the leakage in the system, the poorer the quality of the gripper system. Accordingly, low leakage leads to a high quality assessment value.

The value is provided via IO-Link at the beginning of the next suction cycle.

PERFORMANCE CALCULATION

Similar to the quality assessment, the performance calculation is used to assess the system state. The measured dynamic pressure can be used as a measure of the performance of the gripper system.

Optimally designed gripper systems lead to low dynamic pressures and thus high performance; poorly designed systems result in low performance values.

Dynamic pressure measurements that are greater than the threshold value ($H_2 - h_2$) always result in a performance rating of 0%. A performance rating of 0% is also issued for a dynamic pressure of 0 mbar (which serves as an indication that the measurement was not valid).

The value is provided via IO-Link at the beginning of the next suction cycle.

4 OPERATING AND MENU CONCEPTS

The unit is operated via four buttons on the foil keypad. Settings are made using software menus. The operating structure is divided into settings in the main menu and in the configuration menu. Configuring the ejector in the main menu is sufficient for standard applications. An extended configuration menu is available for applications with special requirements.

The ejector is in display mode when the menus are not being accessed. The current vacuum or the current system pressure is displayed.



If settings are changed, this can cause undefined changes to the system status for a short period of time (approx. 50 ms) in certain situations.

INDIVIDUAL FUNCTIONS

A particular function is assigned to each button on the foil keypad when the ejector is in display mode.

PRESSURE DISPLAY

Pressing the  button displays the current system pressure. This function is only available in devices with an integrated pressure sensor (SXPi – xx – PC – xx).

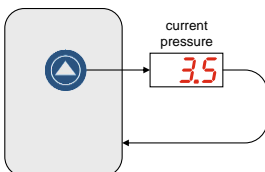

Pressing the  button exits the display of the current system pressure.

VACUUM/PRESSURE UNITS

Pressing the  button displays the current units in which the vacuum/pressure value is displayed.

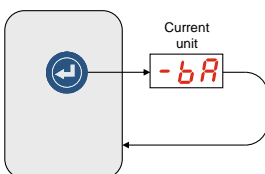

The display returns to the vacuum display after 3 s.

OPERATING MODE DISPLAY

Pressing the  button displays the current operating mode. This is either standard SIO mode or IO-Link mode.

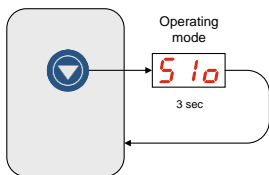

The display returns to the vacuum display after 3 s.

MAIN MENU



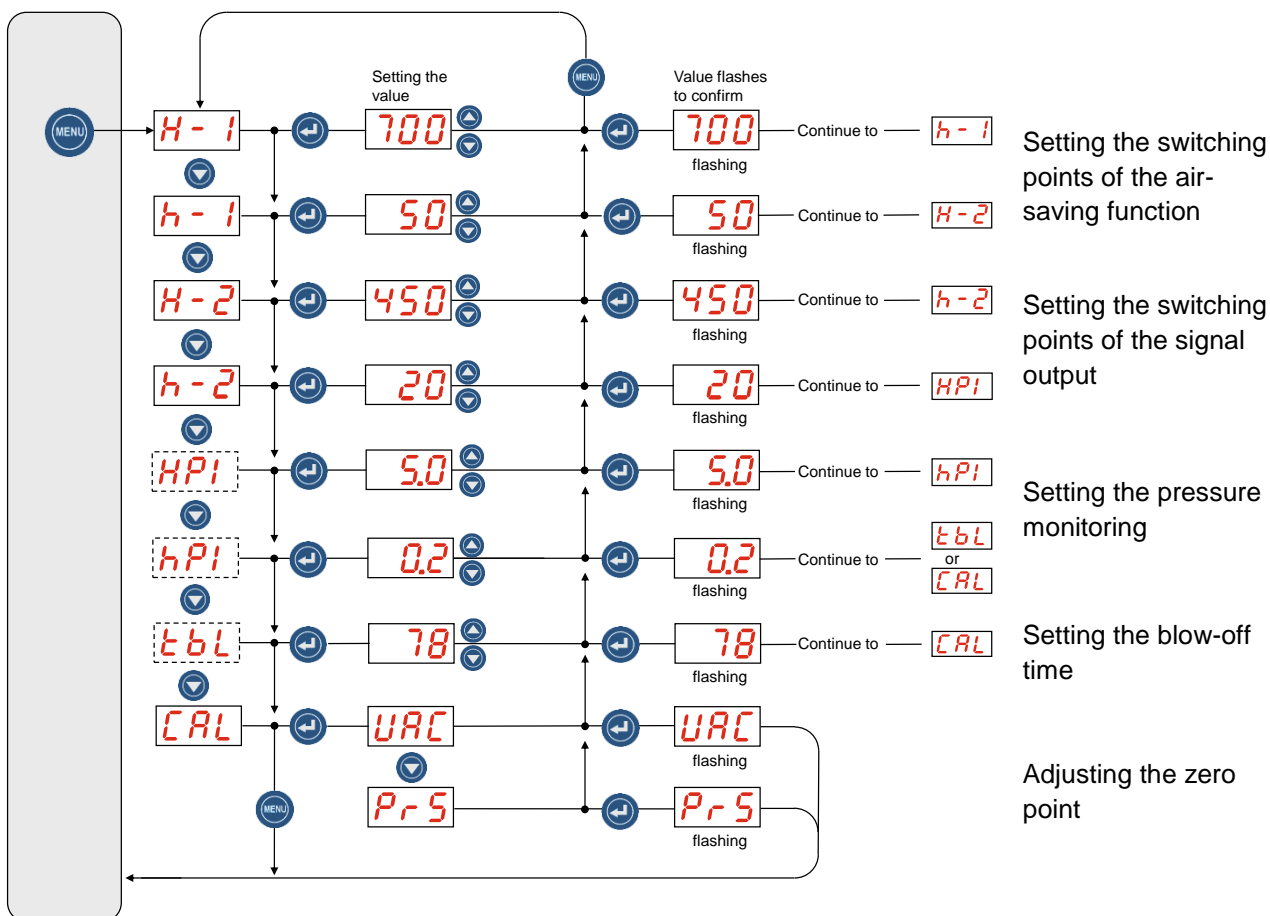



All settings for standard ejector applications can be read and changed using the main menu.





Functions with dashed borders are either not available for all versions or are only available in conjunction with certain functions.

SETTING THE PARAMETERS IN THE MAIN MENU

Briefly press the  button to set the parameters in the main menu.

- Select the desired parameter using the  and  buttons.
- Confirm by pressing the  button.
- Change the value using the  and  buttons.
- Press the  button to save the changed value.









If the  or  button is pressed for approx. 3 seconds, the value to be changed begins to quickly scroll through the available options.



Pressing the  button abandons a changed value without saving it.

ZERO-POINT ADJUSTMENT (CALIBRATION)

Briefly press the  button to adjust the zero point of the integrated sensors.

- Press  or  until **[CAL]** appears in the display.
- Confirm by pressing the  button.
- Use the  and  buttons to select between **[UAC]** (calibrate the vacuum sensor) and **[PrS]** (calibrate the pressure sensor).
- Confirm by pressing the  button.

CONFIGURATION MENU



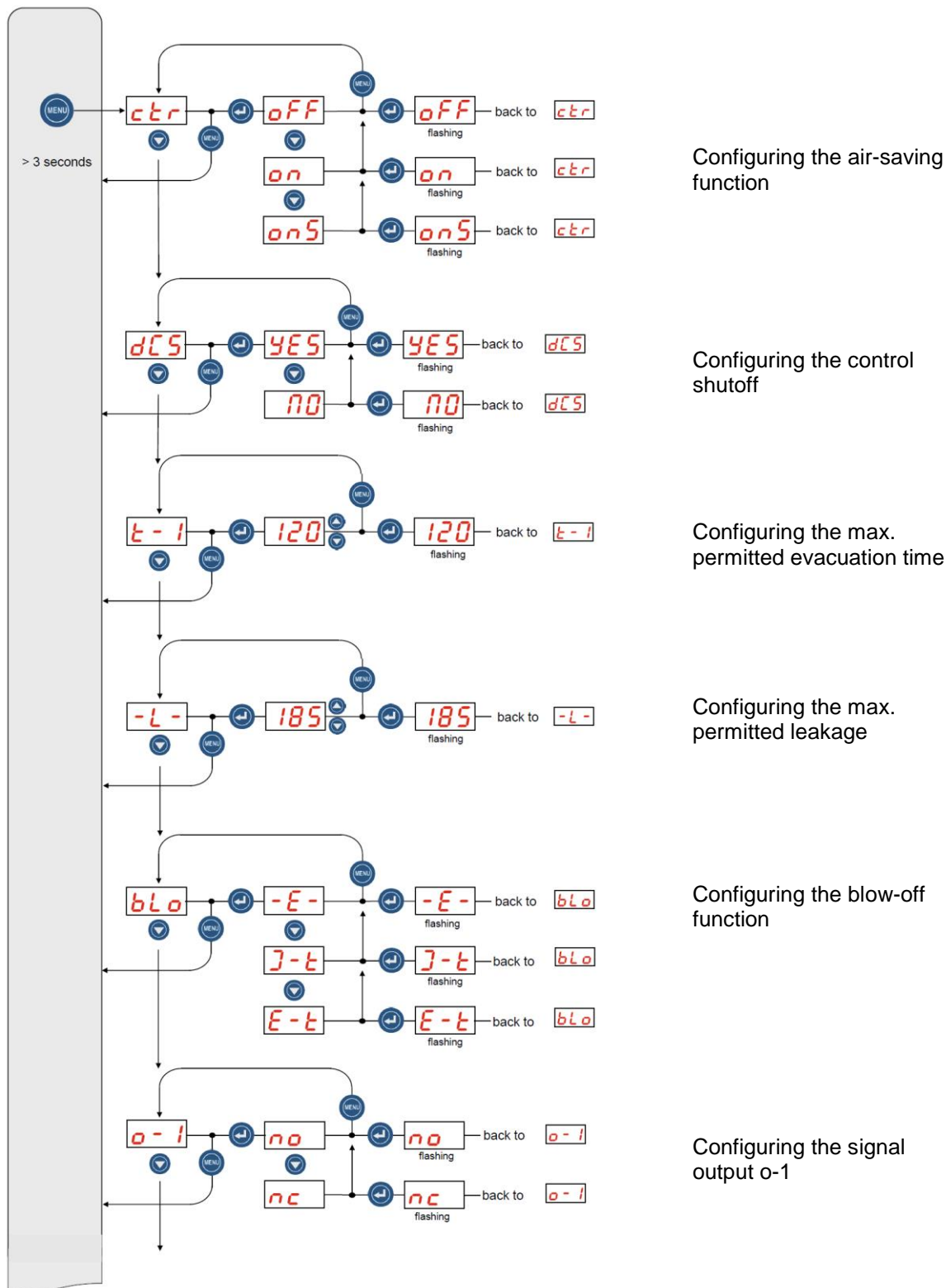

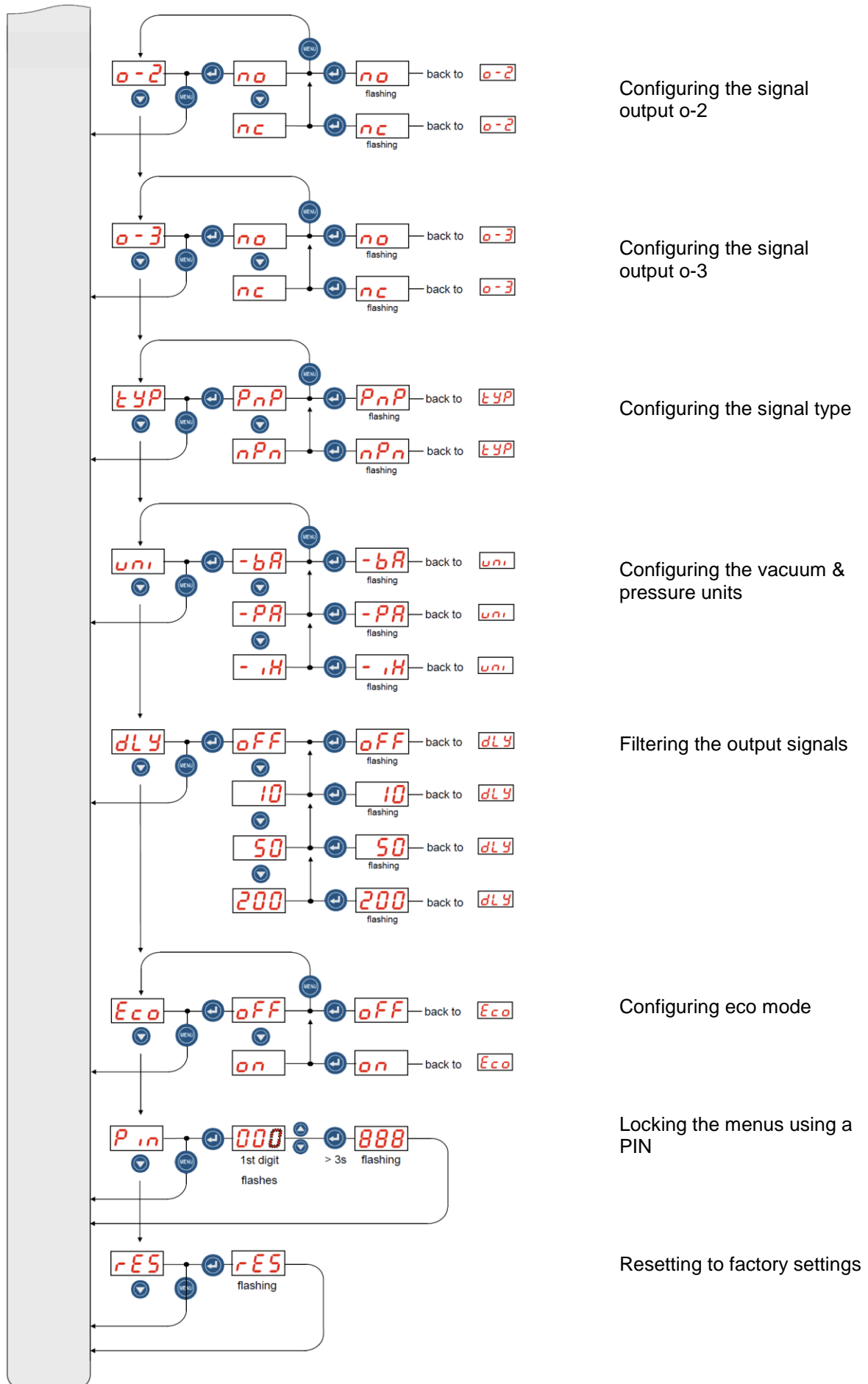

An extended configuration menu is available for applications with special requirements. The operating structure is as follows:







SETTING THE PARAMETERS IN THE CONFIGURATION MENU

Press the  button for longer than 3 s to set the parameters in the configuration menu.

- Select the desired parameter using the  and  buttons.
- Confirm by pressing the  button.
- Change the value using the  or  button.
- Press the  button to save the changed value.











If the  or  button is pressed for approx. 3 seconds, the value to be changed begins to quickly scroll through the available options.



Pressing the  button abandons a changed value without saving it.

ENTERING THE PIN



Press the  for longer than 3 s to enter the PIN.

- Use the  and  buttons to select the **[Pin]** menu item.
- Confirm by pressing the  button.
- Enter the first digit of the PIN code using the  and  buttons.
- Confirm by pressing the  button.
- Enter the remaining digits in the same way.
- Press the  button for longer than 3 seconds to save the PIN.

[Loc] flashes in the display and the configuration menu is exited.

EXECUTING THE “RESET TO FACTORY SETTINGS” FUNCTION

Press the  button for longer than 3 seconds to execute this function.

- Use the  and  buttons to select the **[rES]** menu item.
- Press the  button for more than 3 seconds to reset to the factory settings.



After confirmation, the display flashes for three seconds and then automatically returns to display mode.

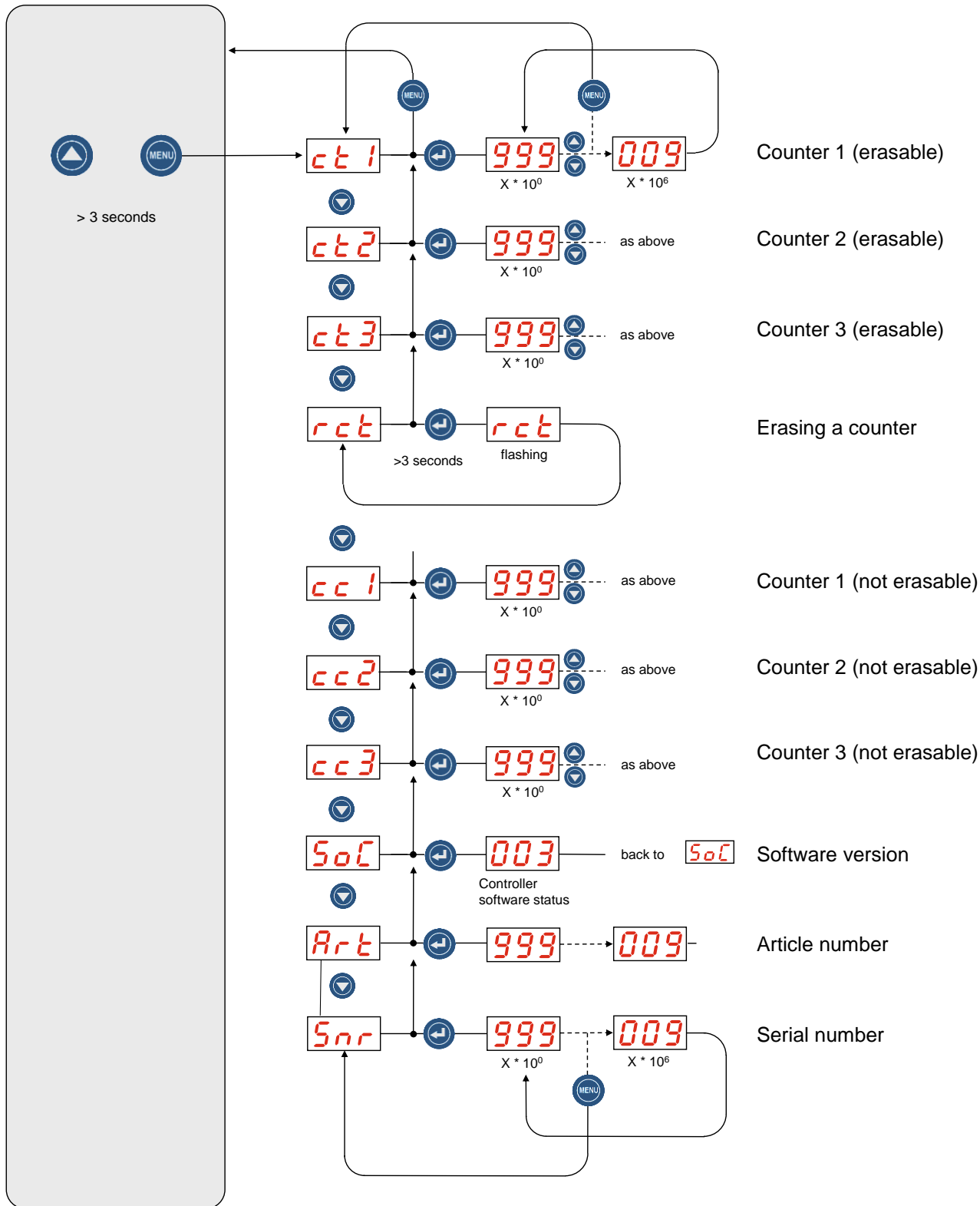

SYSTEM MENU

A special menu is available for reading system data such as counter values, the article number and the serial numbers as well as the software versions. The operating structure is as follows:





DISPLAYING COUNTERS



Press and hold the  and  buttons together for longer than 3 seconds to display the counters.

- Use the  and  buttons to select the desired counter from among [ct1], [ct2], [ct3], [cc1], [cc2] or [cc3].
- Confirm by pressing the .

The last three decimal places of the total counter value are displayed. The decimal point at the far right flashes. This corresponds to the three-digit block with the lowest significance.

The remaining decimal places of the total counter value can be displayed using the  and  buttons. The decimal points indicate which three-digit block of the total counter value is shown in the display.



The total counter value consists of all the three-digit blocks together:

Displayed places	10^6	10^3	10^0
Block of digits			

The current total counter value in this example is 48 618 593.

ERASING A COUNTER



To erase the temporary counters [ct1], [ct2] and [ct3], press the  and  buttons simultaneously for longer than 3 seconds.



- Use the  and  buttons to select the [rct] function.
- Press the  button for longer than 3 seconds to erase the counters.

After confirmation, the display flashes for 3 seconds.

SOFTWARE VERSION



The software version indicates the software currently running on the internal controller.



Press and hold the  and  buttons together for longer than 3 seconds to display the software version.

- Use the  and  buttons to select the [SoC] function.
- Confirm by pressing the .



SERIAL NUMBER

The serial number indicates the period in which the ejector was manufactured.



Press and hold the  and  buttons together for longer than 3 seconds to display the serial number.

- Use the  and  buttons to select the **[Snr]** function.
- Confirm by pressing the  button.

The last three decimal places of the serial number are displayed. The decimal point at the far right flashes. This corresponds to the three-digit block with the lowest significance.



The remaining decimal places of the serial number can be displayed using the  and  buttons. The decimal points indicate which three-digit block of the serial number is shown in the display.



The serial number consists of all the three-digit blocks together:

Displayed places	10^6	10^3	10^0
Block of digits			

The current serial number in this example is 48 618 593.





ARTICLE NUMBER

Press and hold the  and  buttons together for longer than 3 seconds to display the article number.

- Use the  and  buttons to select the **[Art]** function.
- Confirm by pressing the  button.

The first two places of the article number are shown initially. Press the  button to display the remaining places of the article number. The decimal points displayed are part of the article number. The article number consists of 11 places in total.

The article number therefore consists of four blocks of digits:

	1	2	3	4
Block of digits				

The article number in this example is 10.02.02.003830.



Pressing the  button exits these displays in the system menu.

5 OPERATING MODE

All ejectors of the SX(M)Pi series have two operating modes. Users can choose between direct connection to inputs and outputs (serial I/O = SIO mode) or connection through the communication line (IO-Link).

By default, the ejector always runs in SIO mode, but it can be switched in and out of IO-Link operating mode by the connected IO-Link master at any time.

SIO OPERATING MODE

OVERVIEW

When the ejector is operated in SIO mode, all signal inputs and outputs are connected to a controller either directly or via intelligent connection boxes.

In addition to the power supply connection, this mode requires three signal inputs and three signal outputs, via which the ejector communicates with the controller.

With these connections, the basic functions of the ejector can be used, including suction, blow-off and feedback signals. The individual connections are as follows:

Ejector inputs	Ejector outputs
<ul style="list-style-type: none"> ▪ Suction ON/OFF ▪ Blow-off ON/OFF ▪ Diagnostics/analysis function 	<ul style="list-style-type: none"> ▪ Feedback H1/HP1 ▪ Feedback H2 ▪ Diagnostics message from the condition monitoring functions

The parameters are set and the internal counters are read exclusively via the operating and display elements.

The energy monitoring (EM) and predictive maintenance (PM) functions are not available in SIO mode.

MOUNTING

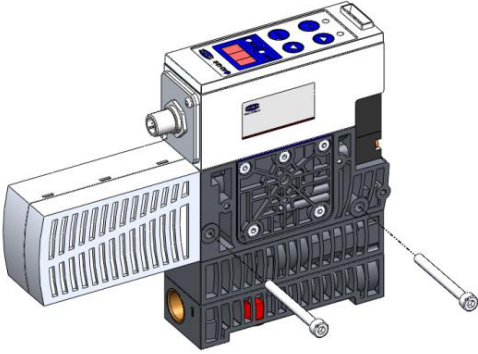
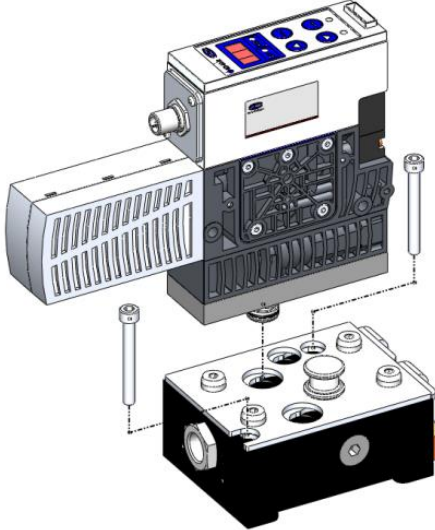
SX(M)Pi – xx – H – xx	SX(M)Pi – xx – Q – xx
	
<p>The following sequence must be observed when mounting the ejector on the quick-change system:</p> <ul style="list-style-type: none"> ▪ Press release lever in all the way and hold it in place. ▪ Place the ejector onto the quick-change system with the centering pins in the correct position and push all the way down. ▪ Allow the release lever to extend back to its original position. 	
<p>The maximum tightening torque for the fastening screws is 6 Nm.</p>	



Only start operation of the ejector system if the release lever is fully extended and the ejector is correctly locked into place.



Only press the release lever for the quick-change system when the ejector is in the depressurized state.

PNEUMATIC CONNECTION

- Use only well-maintained compressed air (air or neutral gas according to EN 983, filtered to 40 µm, oiled or unoled).
- High-quality compressed air is important to ensure a long service life for the ejector.
- Dirt particles or foreign bodies in the ejector connections, hoses or pipelines can lead to partial or complete ejector malfunction.
- Hoses and pipelines should be laid such that distances are minimized.
- If the internal diameter on the compressed air side is too small, insufficient compressed air will be supplied. This prevents the ejector from performing as specified in the performance data.

- Excessive flow resistance occurs if the internal diameter on the vacuum side is too small. This leads to both a reduction in suction capacity and increased evacuation times. Blow-off times are also lengthened.
- Hose lines must be laid without bends or crimps.
- Only use hoses or pipes with the internal diameters recommended for the ejector. If this is not possible, use the next largest internal diameter.

RECOMMENDED LINE CROSS-SECTIONS (INTERNAL DIAMETERS)

SXPi/ SXMPi performance class	Line cross-section (internal diameter) [mm] ¹⁾	
	Compressed air side	Vacuum side
15	6	6
20	6	8
25	8	9
30	8	9

¹⁾ Based on a maximum hose length of 2 m. For longer hoses, the cross-section should be correspondingly larger.

ELECTRICAL CONNECTION

- The electrical connection of the ejector consists of an 8-pin or two 5-pin M12 connectors.
- The plug connectors may not be connected or disconnected while the system is live.
- The ejector may only be operated using power supply units with protected extra-low voltage (PELV). The system must incorporate safe electrical cut-off of the power supply in compliance with EN60204.
- The lines for the power supply, the signal inputs and the signal outputs can have a maximum length of 30 meters.

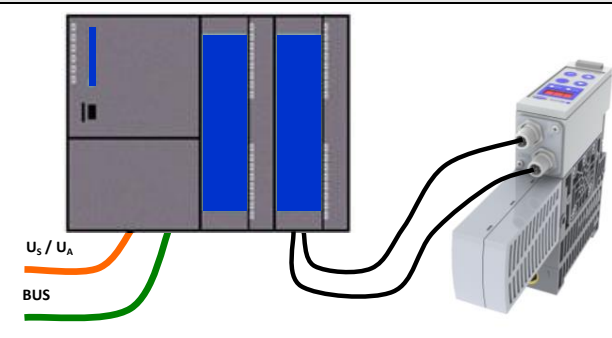
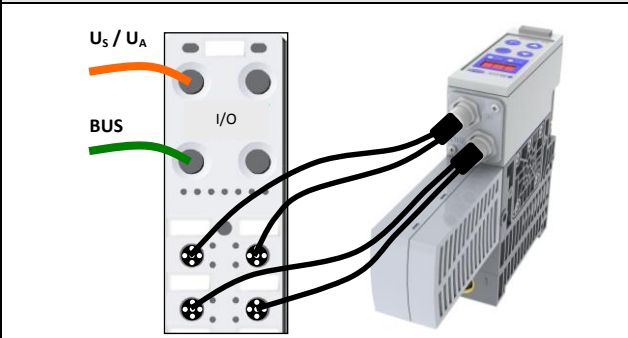
Direct connection	Connection via I/O box
	
<p>Schmalz connection lines may be used to connect the ejector directly to the controller.</p> <ul style="list-style-type: none"> ▪ Art. no. 21.04.05.00080 (5-pin) ▪ Art. no. 21.04.05.00079 (8-pin) 	<p>Schmalz connection distributors may be used to connect the ejector to IO boxes.</p> <ul style="list-style-type: none"> ▪ IN: art. no. 10.02.02.02824 ▪ OUT: art. no. 10.02.02.02921

PIN ASSIGNMENT OF THE CONNECTION PLUG

2 x M12 5-PIN CONNECTOR

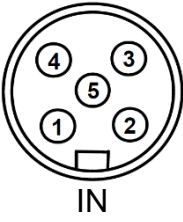
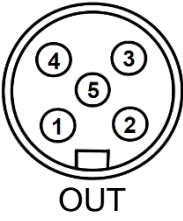
Plug	Pin	Lead color ¹⁾	Symbol	Function
 <p>IN</p>	1	Brown	V _A	Power supply for actuator
	2	White	IN2	Blow-off signal input
	3	Blue	Gnd _A	Actuator ground
	4	Black	IN1	Suction signal input
	5	Gray	IN3	DAF signal input ³⁾
 <p>OUT</p>	1	Brown	V _S	Power supply for sensor
	2	White	OUT2	“Part present control” signal output (H2/h2)
	3	Blue	Gnd _S	Sensor ground
	4	Black	OUT1	Air-saving function or pressure signal output (H1 or HP1)
	5	Gray	OUT3	Diagnostics signal output

M12 8-PIN CONNECTOR

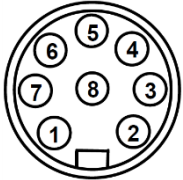
Plug	Pin	Lead color ²⁾	Symbol	Function
	1	White	OUT2	“Part present control” signal output (H2/h2)
	2	Brown	V _{SA}	Power supply for sensor/actuator
	3	Green	OUT3	Diagnostics signal output
	4	Yellow	IN1	Suction signal input
	5	Gray	OUT1	Air-saving function or pressure signal output (H1 or HP1)
	6	Pink	IN2	Blow-off signal input
	7	Blue	Gnd _{SA}	Ground for sensor/actuator
	8	Red	IN3	DAF signal input ³⁾

¹⁾ When Schmalz connection line is used, art. no. 21.04.05.00080

²⁾ When Schmalz connection line is used, art. no. 21.04.05.00079

³⁾ DAF analysis function: See the “Diagnostics/analysis function” section



The system may only be operated using power supply units with protected extra-low voltage (PELV) and safe electrical cut-off of the operating voltage, in accordance with EN60204.
Do not forcibly connect or disconnect plug connectors.



The behavior of the ejector may change when the supply voltage is switched on or when the M12 connectors are plugged in. Depending on the function of the machine/system, this can result in serious personal injury or damage to the equipment.

PROJECT PLANNING

To operate the ejector in SIO mode, all process signals must be wired in parallel. Each ejector therefore requires six lines for the process signals.

PROCESS DATA INPUT

Signal	Symbol	Parameter
0	OUT 1	Switching point H1/HP1
1	OUT 2	Switching point H2
2	OUT 3	Diagnostics

PROCESS DATA OUTPUT

Signal	Symbol	Parameter
0	IN 1	Suction ON/OFF
1	IN 2	Blow-off ON/OFF
2	IN 3	Diagnostics/analysis function ON

START OF OPERATIONS

A typical handling cycle is divided into three steps: pick-up, blow-off and the idle state. During the pick-up step, output 2 is monitored to determine whether a sufficient vacuum has been established.

Step	SX(M)Pi – xx – NO – xx			SX(M)Pi – xx – NC – xx			SX(M)Pi – xx – IMP – xx		
	Signal	State		Signal	State		Signal	State	
1	IN1	Suction ON		IN1	Suction ON		IN1	Suction ON	
2	OUT2	Vacuum > H2		OUT2	Vacuum > H2		OUT2	Vacuum > H2	
3	IN1	Suction OFF		IN1	Suction OFF		IN2	Blow-off ON	
4	IN2	Blow-off ON		IN2	Blow-off ON		IN2	Blow-off OFF	
5	IN2	Blow-off OFF		IN2	Blow-off OFF		OUT2	Vacuum < (H2-h2)	
6	OUT2	Vacuum < (H2-h2)		OUT2	Vacuum < (H2-h2)		Blow-off ON = Suction OFF		

Signal status switches from inactive to active | Signal status switches from active to inactive

WARNINGS AND ERRORS











WARNINGS

Events related to the condition monitoring functions are issued via output 3 of the ejector; these events provide information about the state of the process.

See the “Condition monitoring” section.

ERROR

Error messages from the ejector are shown in the display.

Symbol	Error code
	Electronics error
	Zero point of vacuum/pressure sensor adjusted outside of $\pm 3\%$ FS
	Insufficient voltage supply to actuator (display alternates with current vacuum value)
	Manual mode not possible during blow-off mode
	Insufficient voltage supply to sensor
	Short-circuit at output 1
	Short-circuit at output 2
	Short-circuit at output 3
	Current vacuum or pressure exceeds the measurement range
	Excess pressure in the vacuum circuit/insufficient pressure in the pressure circuit

IO-LINK MODE

OVERVIEW

When operating the ejector in IO-Link mode (digital communication), only the power supply and the communication line must be connected to a controller directly or via intelligent connection boxes.

The communication line for IO-Link (C/Q line) must always be connected to an IO-Link master port (point-to-point connection). It is not possible to connect multiple C/Q lines to only one IO-Link master port.

When the ejector is connected via IO-Link, a number of additional functions are available beyond the basic functions of the ejector (suction, blow-off, feedback signals, etc.). This includes but is not limited to:

- Current vacuum and pressure value
- Condition monitoring events
- Errors
- Status indicator
- Access to all parameters
- Counters
- Condition monitoring
- Energy monitoring



Some of the functions listed are only available in the SX(M)Pi – xx – PC – xx versions (versions with an integrated pressure sensor). See the section “Versions – Additional functions”.

In this mode, all adjustable parameters can be read, changed and written to the ejector directly using the higher-level controller.

The condition and energy monitoring results can be evaluated to produce trend analyses and to provide direct information on the current handling cycle.

Single-byte input data and single-byte output data are transferred as process data. The exchange of process data between the IO-Link master and the ejector is cyclical. The parameter data is exchanged by way of communication modules within the user program in the controller.

MOUNTING

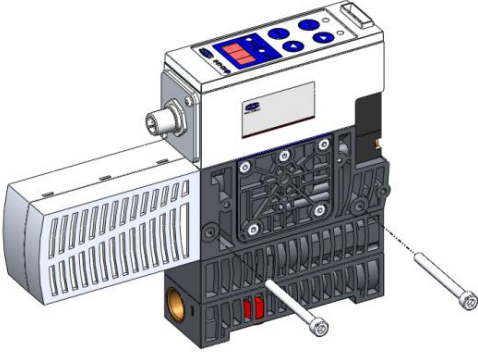
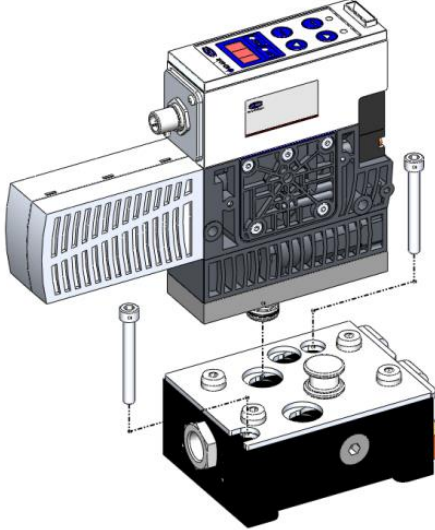
SX(M)Pi – xx – H – xx	SX(M)Pi – xx – Q – xx
	
<p>The following sequence must be observed when mounting the ejector on the quick-change system:</p> <ul style="list-style-type: none"> ▪ Press release lever in all the way and hold it in place ▪ Place the ejector onto the quick-change system with the centering pins in the correct position and push all the way down ▪ Allow the release lever to extend back to its original position 	
<p>The maximum tightening torque for the fastening screws is 6 Nm.</p>	



Only start operation of the ejector system if the release lever is fully extended and the ejector is correctly locked into place.



Only press the release lever for the quick-change system when the ejector is in the depressurized state.

PNEUMATIC CONNECTION

- Use only well-maintained compressed air (air or neutral gas according to EN 983, filtered to 40 µm, oiled or unoled).
- High-quality compressed air is important to ensure a long service life for the ejector.
- Dirt particles or foreign bodies in the ejector connections, hoses or pipelines can lead to partial or complete ejector malfunction.
- Hoses and pipelines should be laid such that distances are minimized.
- If the internal diameter on the compressed air side is too small, insufficient compressed air will be supplied. This prevents the ejector from performing as specified in the performance data.

- Excessive flow resistance occurs if the internal diameter on the vacuum side is too small. This leads to both a reduction in suction capacity and increased evacuation times. Blow-off times are also lengthened.
- Hose lines must be laid without bends or crimps.
- Only hoses or pipes with the internal diameters recommended for the ejector. If this is not possible, use the next largest internal diameter.

RECOMMENDED LINE CROSS-SECTIONS (INTERNAL DIAMETERS)

SXPi/ SXMPi performance class	Line cross-section (internal diameter) [mm] ¹⁾	
	Compressed air side	Vacuum side
15	6	6
20	6	8
25	8	9
30	8	9

¹⁾ Based on a maximum hose length of 2 m

ELECTRICAL CONNECTION

- The electrical connection of the ejector consists of an 8-pin or two 5-pin M12 connectors.
- The plug connectors may not be connected or disconnected while the system is live.
- The ejector may only be operated using power supply units with protected extra-low voltage (PELV). The system must incorporate safe electrical cut-off of the power supply in compliance with EN60204.
- The lines for the power supply and IO-Link can have a maximum length of 20 m.

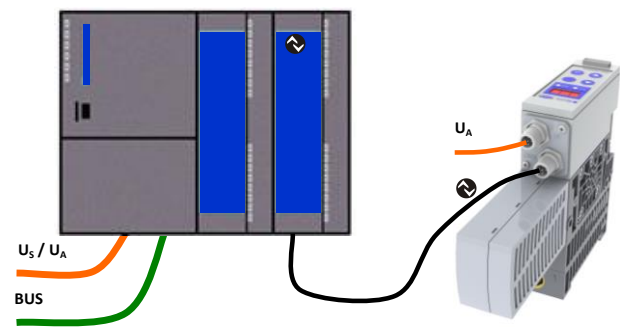
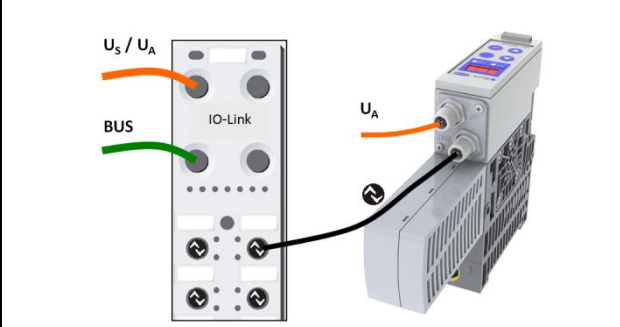
Direct connection	Connection via I/O-link master
	
<p>A Schmalz connection line may be used to connect the ejector directly to the controller.</p> <ul style="list-style-type: none"> ▪ Art. no. 21.04.05.00080 	<p>A Schmalz connection line may be used to connect the ejector to IO-Link master boxes.</p> <ul style="list-style-type: none"> ▪ Art. no. 21.04.05.00158

PIN ASSIGNMENT OF THE CONNECTION PLUG

2 x M12 5-PIN CONNECTOR

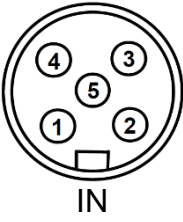
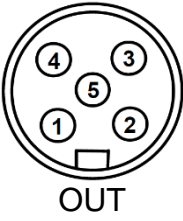
Plug	Pin	Lead color ¹⁾	Symbol	Function
 <p>IN</p>	1	Brown	V_A	Power supply for actuator
	2	White	-	-
	3	Blue	Gnd_A	Actuator ground
	4	Black	-	-
	5	Gray	-	-
 <p>OUT</p>	1	Brown	V_S	Power supply for sensor
	2	White	-	-
	3	Blue	Gnd_S	Sensor ground
	4	Black	C/Q	IO-Link communication line
	5	Gray	-	-

M12 8-PIN CONNECTOR

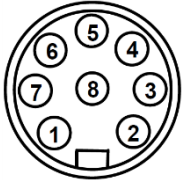
Plug	Pin	Lead color ²⁾	Symbol	Function
	1	White	-	-
	2	Brown	V_{SA}	Power supply for sensor/actuator
	3	Green	-	-
	4	Yellow	-	-
	5	Gray	C/Q	IO-Link communication line
	6	Pink	-	-
	7	Blue	Gnd_{SA}	Ground for sensor/actuator
	8	Red	-	-

¹⁾ When Schmalz connection line is used, art. no. 21.04.05.00080

²⁾ When Schmalz connection line is used, art. no. 21.04.05.00079



Vorsicht

The system may only be operated using power supply units with protected extra-low voltage (PELV) and safe electrical cut-off of the operating voltage, in accordance with EN60204.

Do not forcibly connect or disconnect plug connectors.



DANGER

The behavior of the ejector may change when the supply voltage is switched on or when the M12 connectors are plugged in. Depending on the function of the machine/system, this can result in serious personal injury or damage to the equipment.

PROJECT PLANNING

To operate the ejector in IO-Link mode, you only need to connect an IO-Link connection line (C/Q) in addition to the power supply. Each ejector therefore only requires one line for all process and parameter data.

The following parameters apply for the physical interface:

Parameter	
SIO mode	Yes
Frame type	2.5
Baud rate	38.4 kBd
Minimum cycle time	3.0 ms
Process data input	1 byte
Process data output	1 byte

PROCESS DATA INPUT (PDI)

Bit	Parameter
0	Switching point H2 (part present control)
1	Switching point H1 (control)
2	Switching point HP1 (pressure monitoring)
3	Status indicator red
4	Status indicator green
5	Status indicator flashing
6	Condition monitoring event (see parameter index: 0x0092)
7	Error event (see parameter index: 0x0082)

PROCESS DATA OUTPUT (PDO)

Bit	Parameter
0	Suction ON/OFF
1	Blow-off ON/OFF
2	Set-up mode ON/OFF

PARAMETER DATA – IDENTIFICATION

SPDU index	Parameter	Length	r/w	Default
0x0007	Vendor ID	2 bytes	ro	0x00
0x0008				0xEA
0x0009	Device ID	3 bytes	ro	0x01
0x000A				0x87
0x000B				0x73
0x0010	Vendor name	15 bytes	ro	J. Schmalz GmbH
0x0011	Vendor text	15 bytes	ro	www.schmalz.com
0x0012	Product name	32 bytes	ro	SXPi series
0x0013	Product ID	17 bytes	ro	10.02.02.00000/00
0x0014	Product text	30 bytes	ro	SXMPi 00 IMP Q 2xM12
0x0015	Serial number	9 bytes	ro	000000001
0x0016	Hardware revision	3 bytes	ro	
0x0017	Firmware revision	3 bytes	ro	

PARAMETER DATA – ONLINE

SPDU index	Parameter	Length	Range	r/w	Comment
0x0040	System vacuum	2 bytes	0-999	ro	Unit: mbar
0x0041	System pressure	2 bytes	0-999	ro	Unit: 1 mbar x 10

PARAMETER DATA – INITIAL SET-UP

SPDU index	Parameter	Length	Range	r/w	Comment
0x0044	Air saving function	1 byte	0 - 2	rw	0 = not active (off) 1 = active (on) 2 = active with supervision (onS)
0x0045	Blow-off mode	1 byte	0 - 2	rw	0 = Externally controlled blow-off (-E-) 1 = Internally controlled blow-off – time-dependent (I-t) 2 = Externally controlled blow-off – time-dependent (E-t)"
0x0046	Output 1 function	1 byte	0 - 1	rw	0 = NO 1 = NC
0x0047	Output 2 function	1 byte	0 - 1	rw	0 = NO 1 = NC
0x0048	Output 3 function	1 byte	0 - 1	rw	0 = NO 1 = NC
0x0049	Signal type	1 byte	0 - 1	rw	0 = PNP 1 = NPN
0x004A	Vacuum display unit	1 byte	0 - 2	rw	0 = mbar 1 = kPa 2 = inHg

0x004B	Output filter	1 byte	0 - 3	rw	0 = Off 1 = 10ms 2 = 50ms 3 = 200ms
0x004C	Eco mode	1 byte	0 - 1	rw	0 = Eco OFF 1 = Eco ON
0x004D	PIN	2 bytes	0 - 999	rw	0 = unlocked >0 = locked
0x004E	Disable continuous suction	1 byte	0 - 1	rw	0 = NO 1 = YES

PARAMETER DATA – PRODUCTION SET-UP

SPDU index	Parameter	Length	Range	r/w	Comment
0x0064	Setpoint H1	2 bytes	$H1 \leq 998 \ \& \ H1 > (H2+h1)$	rw	Unit: mbar
0x0065	Hysteresis h1	2 bytes	$h1 < (H1-H2) \ \& \ h1 \geq 10$	rw	Unit: mbar
0x0066	Setpoint H2	2 bytes	$H2 < (H1-h1) \ \& \ H2 > h2+2$	rw	Unit: mbar
0x0067	Hysteresis h2	2 bytes	$h2 < H2-2 \ \& \ h2 \geq 10$	rw	Unit: mbar
0x0068	Setpoint HP1	2 bytes	$HP1 < 99 \ \& \ HP1 > hP1$	rw	Unit: 1 bar x 0.1
0x0069	Hysteresis hP1	2 bytes	$hP1 < HP1 \ \& \ hP1 > 100$	rw	Unit: 1 bar x 0.1
0x006A	Duration of auto blow	2 bytes	10 - 999	rw	Unit: 1 ms x 10
0x006B	Permissible evacuation time	2 bytes	0 - 999	rw	Unit: 1 ms x 10
0x006C	Permissible leakage value	1 byte	0 - 6	rw	0 = 4 mbar/s 1 = 11 mbar/s 2 = 25 mbar/s 3 = 50 mbar/s 4 = 100 mbar/s 5 = 150 mbar/s 6 = 250 mbar/s

PARAMETER DATA – CALIBRATION

SPDU index	Parameter	Length	Range	r/w	Comment
0x0078	Vacuum sensor offset calibration	1 byte	0 - 1	wo	0 = Nothing 1 = Zero offset; after calibrating 0
0x0079	Pressure sensor offset calibration	1 byte	0 - 1	wo	0 = Nothing 1 = Zero offset; after calibrating 0
0x007A	Reset erasable counters	1 byte	0 - 1	wo	0 = Nothing 1 = Reset erasable counters
0x007B	Factory defaults	1 byte	0 - 1	wo	0 = Nothing 1 = Restore; after restoring 0

PARAMETER DATA – ERROR

SPDU index	Parameter	Length	Range	r/w	Comment
0x0082	Error code	1 byte	0 - 255	ro	

PARAMETER DATA – COUNTER

SPDU index	Parameter	Length	Range	r/w	Comment
0x008C	Vacuum on counter	4 bytes	0 – 1·10 ⁹	ro	Not erasable
0x008D	Valve operating counter	4 bytes	0 – 1·10 ⁹	ro	Not erasable
0x008E	Condition monitoring counter	4 bytes	0 – 1·10 ⁹	ro	Not erasable
0x008F	Erasable vacuum on counter	4 bytes	0 – 1·10 ⁹	ro	Erasable with index 0x007A
0x0090	Erasable valve operating counter	4 bytes	0 – 1·10 ⁹	ro	Erasable with index 0x007A
0x0091	Erasable condition monitoring counter	4 bytes	0 – 1·10 ⁹	ro	Erasable with index 0x007A

PARAMETER DATA – CONDITION MONITORING

SPDU index	Parameter	Length	Range	r/w	Comment
0x0092	Condition monitoring	1 byte	0 - 255	ro	Bit 0 = Valve protection active Bit 1 = Evacuation time longer than t-1 Bit 2 = Leakage rate higher than -L- Bit 3 = H1 not reached in cycle Bit 4 = Dynamic pressure too high Bit 7 = System pressure out of range
0x0093	Leakage range	1 byte	0 - 255	ro	Bit 0 = Leakage >200 mbar/s Bit 1 = Leakage 133 to 200 mbar/s Bit 2 = Leakage 67 to 133 mbar/s Bit 3 = Leakage <67 mbar/s
0x0094	Evacuation time t ₀	2 bytes	0 – 65,535	ro	Time from start of suction to H2 [ms]
0x0095	Evacuation time t ₁	2 bytes	0 – 65,535	ro	Time from H2 to H1 [ms]

PARAMETER DATA – ENERGY MONITORING

SPDU index	Parameter	Length	Range	r/w	Comment
0x009B	Air consumption in %	1 byte	0 - 100	ro	of last suction cycle [%]
0x009C	Air consumption	2 bytes	0 – 65,535	ro	of last suction cycle [NI x 0.1]
0x009D	Energy consumption	2 bytes	0 – 65,535	ro	of last suction cycle [Ws]

PARAMETER DATA – PREDICTIVE MAINTENANCE

SPDU index	Parameter	Length	Range	r/w	Comment
0x00A0	Leakage	2 bytes	0 – 8,000	ro	of last suction cycle [mbar/s]
0x00A1	Dynamic pressure	2 bytes	0 - 999	ro	of last suction cycle [mbar]
0x00A2	Quality	1 byte	0 - 100	ro	of last suction cycle [%]
0x00A3	Performance	1 byte	0 - 100	ro	of last suction cycle [%]

¹⁾ ro = read only | wo = write only

IODD – ELECTRONIC DATA SHEET

An IODD file is required to incorporate the ejector into a controller. This is available for download at www.schmalz.com for the particular ejector type.

If a Siemens controller is used, the IODD must be loaded using the PCT configuration tool and each IO-Link port must be configured.

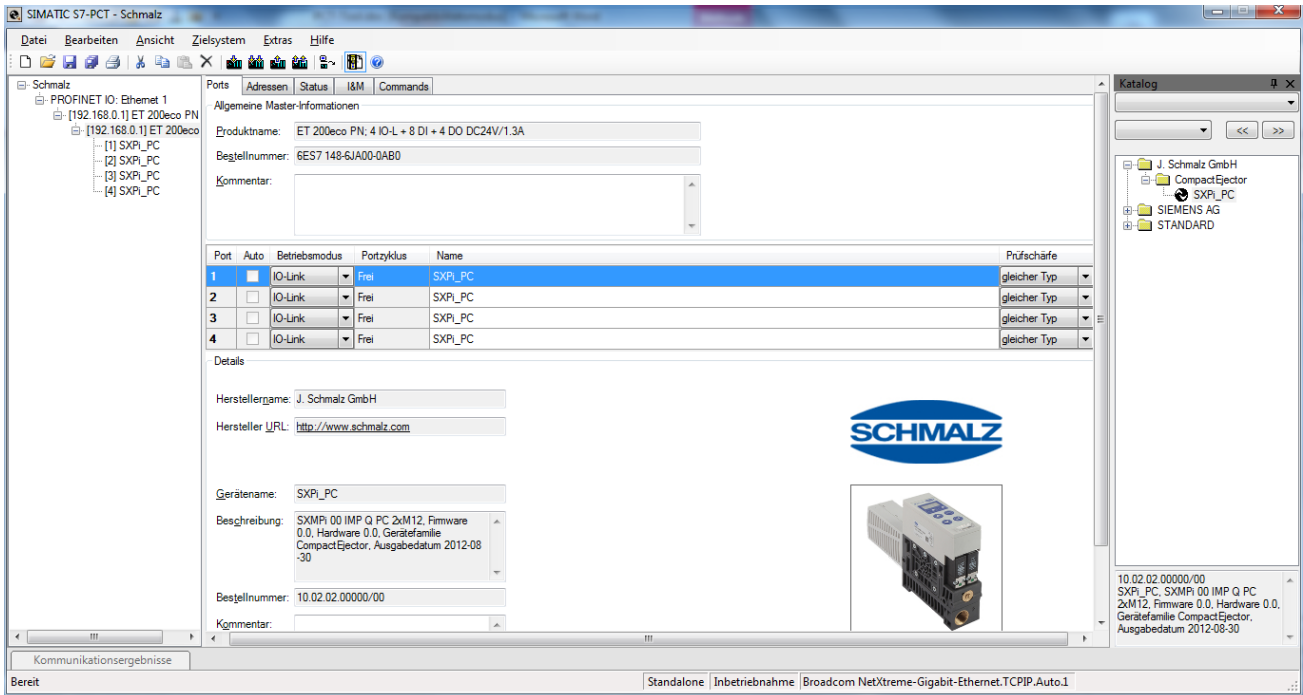

The ejector can then be read out and parameterized online.

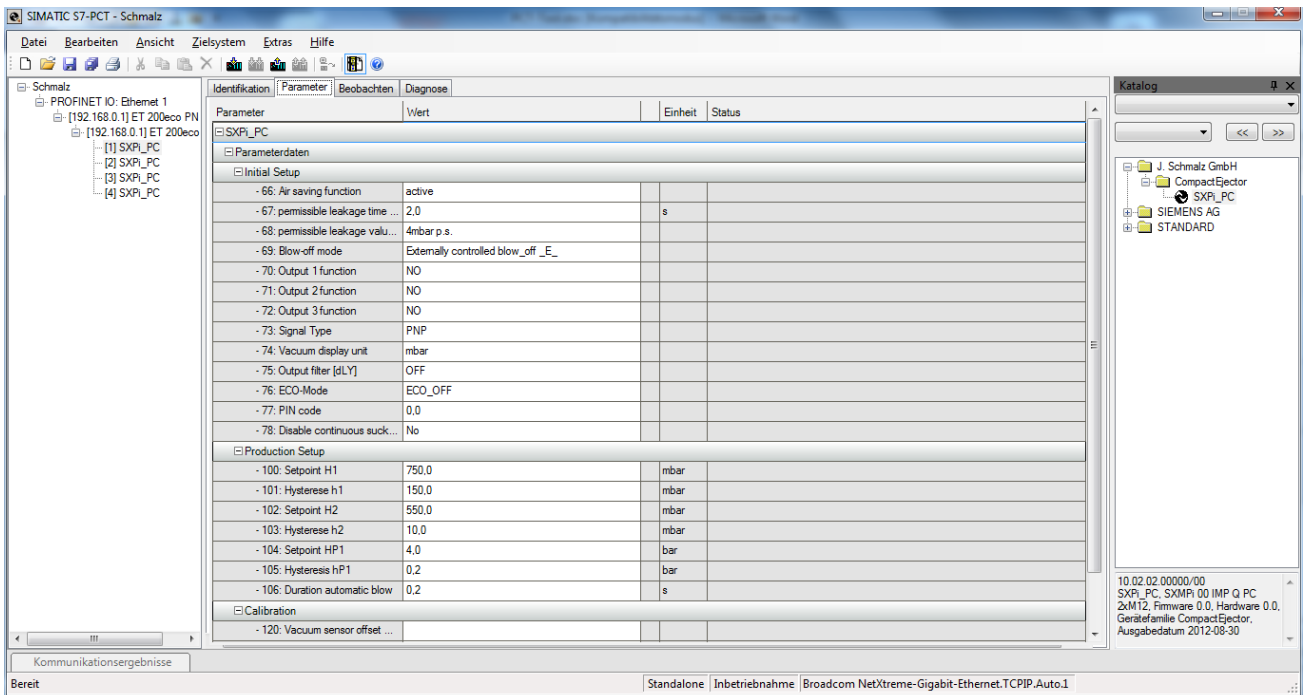

START OF OPERATIONS

The ejector is always in SIO mode after the supply voltage is applied. IO-Link communication is only established after a wake-up signal from the master.



In order for the IO-Link master to establish communication, output OUT1 must be inactive and the ejector must be set to signal type PNP.

The communication LED on the IO-Link master port indicates the IO-Link communication has been successfully established.

Pressing the button displays the operating mode of the ejector.

A typical handling cycle is divided into three steps: pick-up, blow-off and the idle state. During the pick-up step, the switching threshold H2 is monitored to determine whether a sufficient vacuum has been established.

Step	SX(M)Pi – xx – NO – xx		SX(M)Pi – xx – NC – xx		SX(M)Pi – xx – IMP – xx	
	Bit	State	Signal	State	Signal	State
1	PDO 0	Suction ON	PDO 0	Suction ON	PDO 0	Suction ON
2	PDI 0	Vacuum > H2	PDI 0	Vacuum > H2	PDI 0	Vacuum > H2
3	PDO 0	Suction OFF	PDO 0	Suction OFF	PDO 1	Blow-off ON
4	PDO 1	Blow-off ON	PDO 1	Blow-off ON	PDO 1	Blow-off OFF
5	PDO 1	Blow-off OFF	PDO 1	Blow-off OFF	PDI 0	Vacuum < (H2-h2)
6	PDI 0	Vacuum < (H2-h2)	PDI 0	Vacuum < (H2-h2)	Blow-off ON = Suction OFF	

Signal status switches from LOW to HIGH | Signal status switches from HIGH to LOW

CONDITION MONITORING [CM]

Condition monitoring events that arise during the suction cycle are signaled immediately by way of the corresponding bit.

Reading out the CM byte allows you to determine the event that triggered it. To read out all possible CM events that arose during the suction cycle, the CM byte must be read out after the command for suction OFF/blow-off ON. The CM byte is valid until the beginning of a new suction cycle.

The current CM values t_0 and t_1 and the leakage range of the active suction cycle are also available starting from the command for suction OFF/blow-off ON until the beginning of the next suction cycle.

ENERGY MONITORING [EM]

All EM values are available for the previous suction cycle after the next suction cycle has begun; they must therefore be read out after every "Suction ON" command.

PREDICTIVE MAINTENANCE [PM]

All PM values are available for the previous suction cycle after the next suction cycle has begun; they must therefore be read out after every "Suction ON" command.

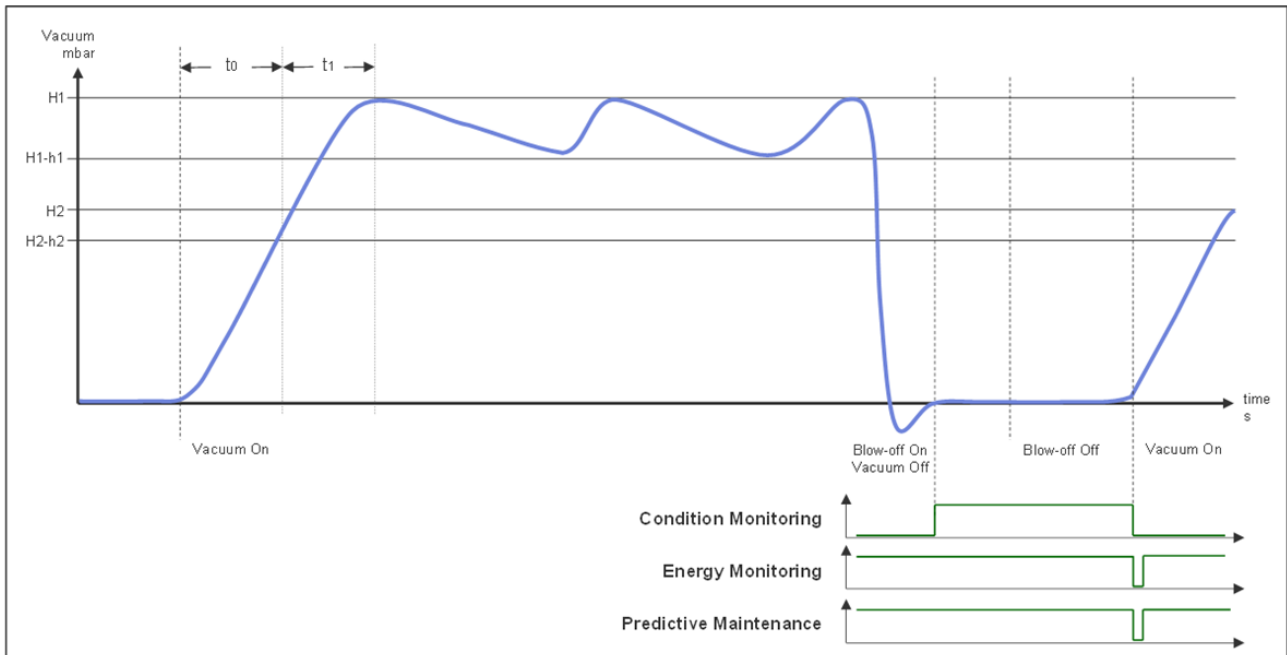

WARNINGS AND ERRORS

WARNINGS

Warnings, especially those that are the result of condition monitoring functions, provide information about the state of the vacuum system and the current handling cycle.

See the “Condition monitoring” section.

Condition monitoring events that arise in the ejector are signaled via bit 6 in the process data byte input (PDI). Parameter 0x0092 can be read out for precise error analysis. The corresponding code for the condition monitoring event is transferred here.

Code	Description
0	No condition monitoring event
1	Valve protection function active
2	Set limit for evacuation time (t-1) exceeded
4	Set limit for leakage (-L-) exceeded
8	Threshold value H1 not reached
16	Dynamic pressure > (H2-h2) and < H1
128	System pressure outside of working range

If multiple condition monitoring events arise within a single suction cycle, their codes are added accordingly.

ERRORS

Errors that arise in the ejector are signaled via bit 7 in the process data byte input (PDI). Parameter 0x0082 can be read out for precise error analysis. The corresponding error code is transferred here.

Code	Description
1	Electronics error
3	Zero point of vacuum/pressure sensor adjusted outside of $\pm 3\%$ FS
5	Insufficient voltage supply to actuator
6	Manual mode not possible during blow-off mode
7	Insufficient voltage supply to sensor

As in SIO mode, the error code is also shown on the display of the ejector.

6 MAINTENANCE

GENERAL MAINTENANCE

EXTERIOR SOILING

Remove dirt on the exterior of the device with a soft cloth and soap suds (max. 60°C). Ensure that the silencer and the controller are not soaked with soap suds.

SILENCER

Because it is open, the silencer may be exposed to high levels of dust, oil, etc., which may dirty the silencer to the point of reducing the suction capacity. If this happens, it must be replaced. Cleaning is not recommended due to the capillary effect of the porous material.

SCREW-IN/PRESS-IN FILTERS

The vacuum and compressed air connections include screw-in/press-in filters. Over time, dust, chips and other solids can become deposited in the filters. If the performance of the ejector system is noticeably reduced, the filters can be unscrewed and cleaned/replaced.



Do not operate the ejector system without the screw-in filters. This can damage the ejector system.

WARRANTY, SPARE PARTS AND WEARING PARTS

This system is guaranteed in accordance with our general terms of trade and delivery. The same applies to spare parts, provided that these are original parts supplied by us.

We are not liable for any damage resulting from the use of non-original spare parts or accessories.

Wearing parts are not covered by the warranty.

The following list contains the primary spare and wearing parts.

- Legend:
- Spare part= **S**
 - Wearing part= **W**
 - Wearing part Assembly, contains wearing parts= **WA**

SPARE AND WEARING PARTS

Type	Designation	Article no.	Legend
	Silencer	10.02.02.02124	W
Base plate GP 2	Screw-in filter 3/8" thread	10.05.03.00013	S
SXPi/SXMPi...H	Filter, 17.5x2	10.02.02.03378	S
...NO...	Suction valve for NO ejector (NO valve)	10.05.01.00278	S
...NC...	Suction valve for NC ejector (NC valve)	10.05.01.00277	S
...IMP...	Suction valve for IMP ejector (pulse valve)	10.05.01.00280	S
	Blow-off valve (NC valve)	10.05.01.00277	S



Observe a maximum torque of 0.75 Nm when tightening the fastening screws on the valve.

TROUBLESHOOTING

Fault	Possible cause	Solution
Vacuum level is not reach or vacuum is created too slowly	Screw-in filter is dirty	Clean screw-in filter
	Silencer is dirty	Replace silencer
	Leakage in hose line	Check hose connections
	Leakage at suction pad	Check suction pad
	Operating pressure too low	Increase operating pressure (observe max. limits)
	Internal diameter of hose lines too small	See recommended hose diameters
Payload cannot be held securely	Vacuum level too low	Increase the control range if the air-saving function is activated
	Suction pad too small	Select a larger suction pad
Display shows an error code	See "Error codes" table	See "Error codes" table

ACCESSORIES

Designation	Article no.
M12 connection cable, 8-pin	21.04.05.00079
M12 connection cable, 5-pin	21.04.05.00080
Connection distributor (IN), M12 5-pin to 2x M12 4-pin	10.02.02.02824
Connection distributor (OUT), M12 5-pin to 2x M12 4-pin	10.02.02.02921
Double base plate with quick-change connection	10.02.02.02154

7 TECHNICAL DATA



Operating the ejector system outside of the specified values can result in damage to the system and attached components.

ELECTRICAL PARAMETERS

Parameter	Symbol	Limit values			Units	Comment
		Min.	Typ	Max.		
Supply voltage	V_{SA}	19.2	24	26.4	V_{DC}	PELV ¹⁾
SX(M)Pi – xx – NO/IMP – xx – 2x M12						
Rated current from V_S ²⁾	I_S	—	—	60	mA	
Rated current from V_A	I_A	—	—	155 130 145	mA	$V_S = 19.2\text{ V}$ $V_S = 24.0\text{ V}$ $V_S = 26.4\text{ V}$
SX(M)Pi – xx – NC – xx – 2x M12						
Rated current from V_S ²⁾	I_S	—	—	60	mA	
Rated current from V_A	I_A	—	—	80 70 75	mA	$V_S = 19.2\text{ V}$ $V_S = 24.0\text{ V}$ $V_S = 26.4\text{ V}$
SX(M)Pi – xx – NO/IMP – xx – M12						
Rated current from V_{SA} ²⁾	I_{SA}	—	—	215 190 205	mA	$V_S = 19.2\text{ V}$ $V_S = 24.0\text{ V}$ $V_S = 26.4\text{ V}$
SX(M)Pi – xx – NC – xx – M12						
Rated current from V_{SA} ²⁾	I_{SA}	—	—	140 130 135	mA	$V_S = 19.2\text{ V}$ $V_S = 24.0\text{ V}$ $V_S = 26.4\text{ V}$
Voltage of signal output (PNP)	V_{OH}	$V_{S/SA}-2$	—	$V_{S/SA}$	V_{DC}	$I_{OH} < 150\text{ mA}$
Voltage of signal output (NPN)	V_{OL}	0	—	2	V_{DC}	$I_{OL} < 150\text{ mA}$
Current of signal output (PNP)	I_{OH}	—	—	150	mA	Short-circuit-proof ³⁾
Current of signal output (NPN)	I_{OL}	—	—	-150	mA	Short-circuit-proof ³⁾
Voltage of signal input (PNP)	V_{IH}	15	—	$V_{A/SA}$	V_{DC}	Relative to $Gnd_{A/SA}$
Voltage of signal input (NPN)	V_{IL}	0	—	9	V_{DC}	Relative to $V_{A/SA}$
Current of signal input (PNP)	I_{IH}	—	5	10	mA	
Current of signal input (NPN)	I_{IL}	—	-5	-10	mA	
Pulse length for suction valve	t_P	50	—	—	ms	
Reaction time of signal inputs	t_I	—	10	—	ms	
Reaction time of signal output	t_O	1	—	200	ms	Adjustable

¹⁾ The power supply must comply with the requirements of EN60204 (protective extra-low voltage).

The power supply, signal inputs and signal outputs are all protected against reverse polarity.

²⁾ Plus the output currents

³⁾ The signal output is protected against short circuits. However, the signal output is not secured against overloading. Constant load currents of $> 0.15\text{ A}$ can lead to unacceptable heat levels and subsequent destruction of the ejector.

DISPLAY PARAMETERS

Parameter	Value	Unit	Comment
Display	3	Digits	Red 7-segment LED
Resolution	± 2	Digits	Unit = mbar
Accuracy	± 3	% FS	T _{amb} = 25 °C, based on FS end value (full scale)
Linearity error	± 1	%	
Offset error	± 2	Digits	After zero-point adjustment, without vacuum (unit = mbar)
Temperature influence	± 3	%	0 °C < T _{amb} < 50°C
Display refresh rate	5	1/s	This only affects the red 7-segment display (see the "Electrical parameters" section for signal inputs and outputs).
Idle time before the menu is exited	2	min	If no settings are made in a menu, the ejector automatically returns to display mode.

MECHANICAL DATA

GENERAL PARAMETERS

Parameter	Symbol	Limit values			Unit	Comment
		Min.	Typ.	Max.		
Ambient temperature	T _{amb}	0	—	50	°C	
Storage temperature	T _{Sto}	-10	—	60	°C	
Humidity	H _{rel}	10	—	90	% r.h.	Free from condensation
Degree of protection		—	—	IP65		
Operating pressure	P	4	5	7	bar	
Operating medium	Air or neutral gas, filtered to 40 µm, oiled or unoled, compressed air w/ quality class 7-4-4 acc. to ISO 8573-1					

MATERIALS USED

Component	Material
Basic body	PA6-GF
Inner components	Anodized aluminum alloy, brass, galvanized steel, stainless steel, PU, POM
Controller housing	PC, PMMA
Pneumatic connection adapter Q	Anodized aluminum alloy, galvanized steel
Pneumatic connection adapter H	PA6-GF
Silencer housing	ABS
Silencer insert	Porous PE
Seals	NBR
Lubricants	Silicone-free

MECHANICAL PARAMETERS

Type	Nozzle size	Max. vacuum ¹	Suction rate ¹	Max. blow-off capacity ¹	Air consumption ¹	Sound level ¹	Weight
	mm	%	l/min	l/min	l/min	dBA	kg
SXPi15	1,5	85	70	200	115	63	0,77
SXPi20	2,0	85	135	200	180	65	0,77
SXMPi15	1,5	85	70	320	115	63	0,91
SXMPi20	2,0	85	135	320	180	65	0,91
SXPi25	2.5	85	185	200	290	67	0.77
SXPi30	3.0	85	220	200	380	72	0.77
SXMPi25	2.5	85	185	320	290	67	0.91
SXMPi30	3.0	85	220	320	380	72	0.91

¹⁾ at 4.5 bar

DIMENSIONS

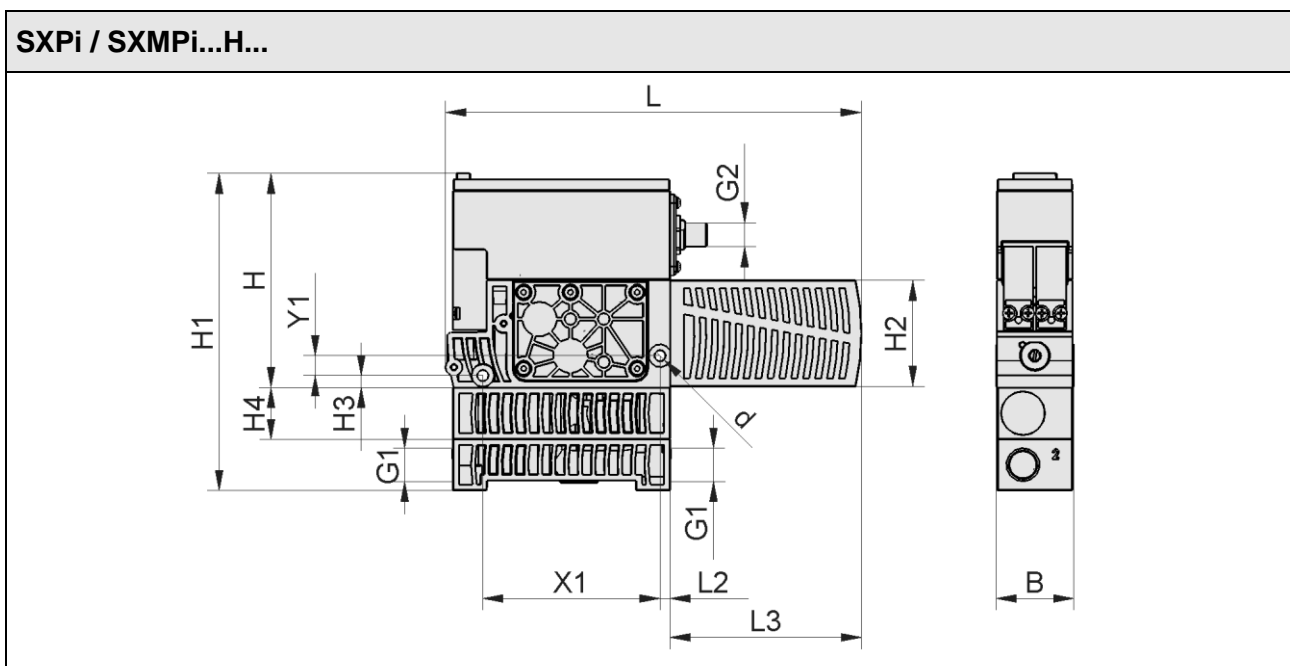

SXPi / SXMPi...Q...

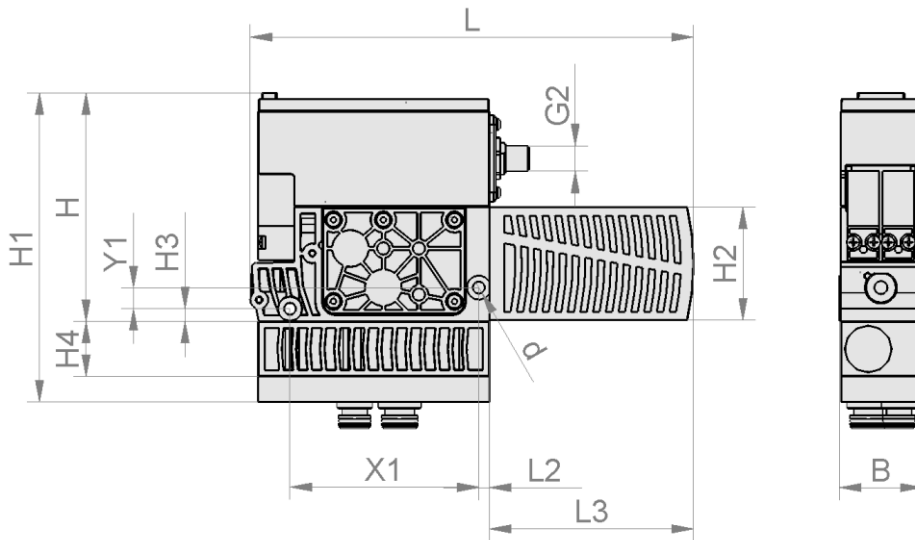

Type	B	d	G1	G2	H	H1	H2	H3	H4	L	L2	L3	X1	Y1
SXPi...H	39	5.5	3/8"	M12	108	134	54	6	-	210	5	97	89	10
SXPi...Q	39	5.5	-	M12	108	121	54	6	-	210	5	97	89	10
SXMPi...H	39	5.5	3/8"	M12	108	160	54	6	26	210	5	97	89	10
SXMPi...Q	39	5.5	-	M12	108	147	54	6	26	210	5	97	89	10



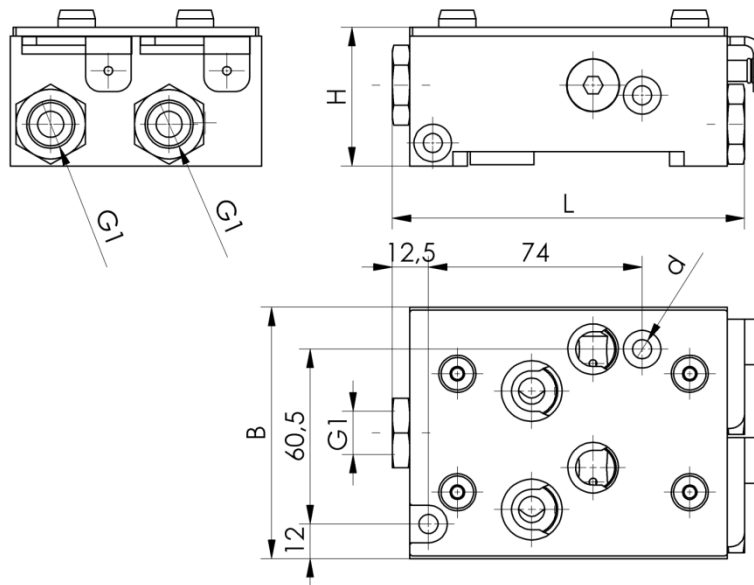



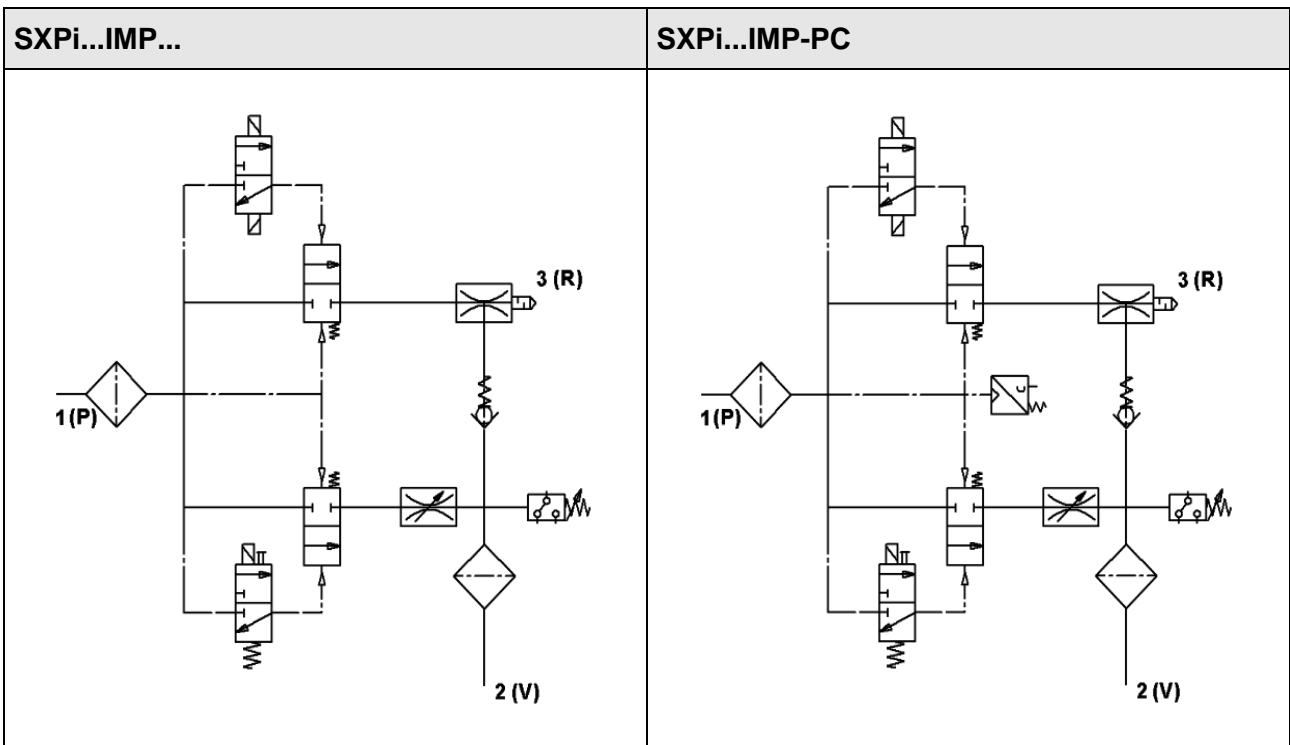
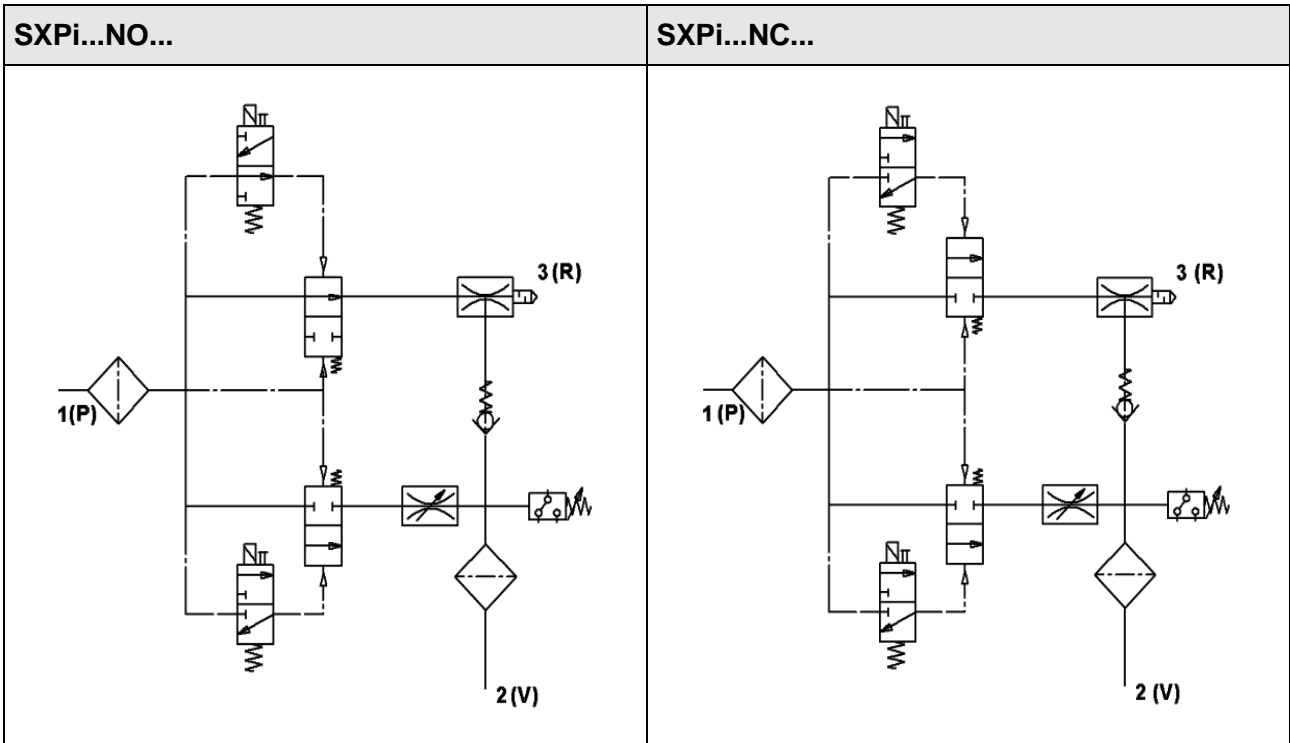















Base plate GP2



Type	B	d	G1	G2	H	L
GP2	87	6.6	3/8"	-	48	122



OVERVIEW OF DISPLAY SYMBOLS

Symbol	Function	Comment
	Switching point H1	Switch-off value for the air-saving function
	Hysteresis h1	Hysteresis of the air-saving function
	Switching point H2	Switch-on value for the "part present control" signal output (when NO output is configured)
	Hysteresis h2	Hysteresis of "part present control" signal output
	Switching point HP1	Switch-on threshold for pressure monitoring
	Hysteresis hp1	Hysteresis for pressure monitoring
	Blow-off time	Blow-off time setting for time-controlled blow-off
	Zero-point adjustment (calibration)	Select function for pressure or vacuum sensor
	Zero-point adjustment for the vacuum sensor	Setting the zero point of the vacuum sensor
	Zero-point adjustment of the pressure sensor	Setting the zero point of the pressure sensor
	Counter 1	Counter for suction cycles (suction signal input)
	Counter 2	Counter for valve switching frequency
	Counter 3	Counter for condition monitoring events
	Erase counter	Erases counters ct1, ct2 and ct3
	Total counter 1	Counter for suction cycles (suction signal input)
	Total counter 2	Counter for valve switching frequency
	Total counter 3	Counter for condition monitoring events
	Software version	Displays the current software version
	Serial number	Displays the serial number of the ejector
	Article number	Displays the article number of the ejector
	Vacuum unit	Vacuum unit in which the measurement and setting values are displayed
	Vacuum value in mbar	The vacuum and pressure values are displayed in mbar.

-PA	Vacuum value (in kPa)	The vacuum and pressure values are displayed in kPa.
-IH	Vacuum value in inHg	The vacuum and pressure values are displayed in inHg.
t-1	Evacuation time	Setting for the maximum permitted evacuation time
-L-	Leakage value	Setting for the maximum permitted leakage
dLY	Switch-off delay	Setting for the switch-off delay for OUT1 and OUT2
Eco	ECO mode	Configuring ECO mode
tYP	Configuration of signal type	Menu for configuring the signal type (NPN/PNP)
PnP	PNP signal type	All input and output signals switch according to PNP (input/output on = 24 V)
nPn	NPN signal type	All input and output signals switch according to NPN (input/output on = 0 V)
out	Configuration of signal output	Menu for configuring the signal output
no	Normally open contact	Setting the signal output as a normally open contact
nc	Normally closed contact	Setting the signal output as a normally closed contact
ctr	Air-saving function (control)	Setting for the air-saving function
on	Air-saving function on	Activation of the air-saving function
onS	Air-saving function on with leakage monitoring	Switching on the air-saving function with leakage monitoring
off	Air-saving function off	Deactivation of the air-saving function
dcS	Deactivate continuous suction	Enabling continuous suction
YES	Continuous suction is deactivated	Selection: continuous suction is deactivated
no	Continuous suction is activated	Selection: continuous suction is activated
blo	Blow-off function	Menu for configuring the blow-off function
-E-	“External” blow-off	Selection of externally controlled blow-off (external signal)
J-t	“Internal” blow-off	Selection of internally controlled blow-off (triggered internally; time can be set)
E-t	“Externally time-controlled” blow-off	Selection of externally controlled blow-off (triggered externally; time can be set)
P.in	PIN	Enter the PIN to unlock the menu
rES	Reset	All values that can be changed are reset to the factory settings.

Loc	Menu locked	A lock prevents parameters from being changed.
Unc	Menu unlocked	The buttons and menus are unlocked.

FACTORY SETTINGS

Symbol	Function	Factory setting
H-1	Switching point H1	750 mbar
h-1	Hysteresis h1	150 mbar
H-2	Switching point H2	550 mbar
h-2	Hysteresis h2	10 mbar
HP1	Switching point HP1	4.0 bar
hP1	Hysteresis hP1	0.2 bar
tBL	Blow-off time	0.20 s
ctr	Air-saving function	on
dcS	Deactivate continuous suction	no
t-1	Evacuation time	2 s
-L-	Leakage value	250 mbar/s
blo	Blow-off function	-E- Externally controlled blow-off
out	Configuration of outputs	no Normally open contact
typ	Signal type	PNP PNP switching
uni	Vacuum unit	-bA Vacuum unit (in mbar)
dLY	Switch-off delay	10 ms
Eco	ECO mode	oFF
P in	PIN	000

8 CONFORMITY DECLARATION

DE EG-Konformitätserklärung
 EN EC- Declaration of Conformity
 FR CE-Déclaration de conformité
 ES Certificado de conformidad CE
 IT Dichiarazione di conformità CE
 NL CE Conformiteitsverklaring



Hersteller / Manufacturer / Fabricant / Fabricante / Produttore / Fabrikant

J. Schmalz GmbH, Aacher-Str. 29, D - 72293 Glatten

Produktbezeichnung / Product name / Designation du produit /
 Denominación del producto / Denominazione del prodotto / Beschrijving van de machine

Ejektoren der Serie / Ejectors series / Ejecteurs de la série / Eyectores de la serie / Eiettori de la serie / Ejector Serie

SXP / SXMP
 SXPI / SXMPI

Erfüllte einschlägige EG-Richtlinien / Applicable EC directives met / Directives CE applicables respectées /
 Directivas vigentes de la CE cumplidas / Direttive CE applicate ed osservate / Nagekomen betreffende EG-richtlijnen

- 2006/42/EG Maschinenrichtlinie / Machinery Directive / Directive sur les machines /
 Directiva para máquinas / Direttiva macchine / Machinerichtlijn
- 2004/108/EG Elektromagnetische Verträglichkeit / Electromagnetic Compatibility / Compatibilité électromagnétique /
 Compatibilidad electromagnética / Compatibilità elettromagnetica / Elektromagnetische compatibiliteit

Angewendete harmonisierte Normen / Harmonised standards applied / Normes d'harmonisation appliquées /
 Normas armonizadas aplicadas / Norme armonizzate adottate / Toegepaste geharmoniseerde normen

- EN ISO 12100 Sicherheit von Maschinen - Allgemeine Gestaltungsleitsätze - Risikobeurteilung und Risikominderung / Safety of Machinery -
 General principles for design - Risk assessment and risk reduction / Sécurité des machines - Principes généraux de conception -
 Appréciation du risque et réduction du risque / Seguridad de máquinas - Principios generales de diseño - Evaluación del riesgo y
 reducción del riesgo / Sicurezza delle macchine - Principi generali di progettazione - Valutazione del rischio e riduzione del rischio
 / Veiligheid van machines - Algemene beginselen voor ontwerp - Risicobeoordeling en de risicoreductie
- EN 61000-6-3 Elektromagnetische Verträglichkeit - Störaussendung / Electromagnetic Compatibility - Emission /
 Compatibilité électromagnétique - Norme sur l'émission / Compatibilidad electromagnética - Emisión de interferencias /
 Compatibilità elettromagnetica - Norma generica sull'emissione / Elektromagnetische compatibiliteit - emissie
- EN 61000-6-2 Elektromagnetische Verträglichkeit - Störfestigkeit / Electromagnetic Compatibility - Immunity /
 Compatibilité électromagnétique - Immunité / Compatibilidad electromagnética - Resistencia a interferencias /
 Compatibilità elettromagnetica - Immunità / Elektromagnetische compatibiliteit - immunititeit
- EN ISO 4414 Fluidtechnik - Allgemeine Regeln und sicherheitstechnische Anforderungen an Pneumatikanlagen und deren Bauteile / Pneumatic
 fluid power - General rules and safety requirements for systems and their components / Transmissions pneumatiques - Règles
 générales et exigences de sécurité pour les systèmes et leurs composants / Energía fluida neumática - reglas generales y
 requisitos de seguridad de sistemas y sus componentes / Potenza idraulica pneumatica - regole generali e requisiti di sicurezza per
 sistemi e loro componenti / Pneumatische hydraulica - algemene regels en veiligheidsvoorschriften voor systemen en hun componenten

Dokumentationsverantwortlicher / Person responsible for documentation / Responsable de la documentation /
 Responsable de documentación / Responsabile della documentazione / Verantwoordelijk voor de documentatie

Klaus-Dieter Fanta / J. Schmalz GmbH, Aacher-Str. 29, D - 72293 Glatten

Unterschrift, Angaben zum Unterzeichner / Signature, details of signatory / Signature, indications sur le soussigné /
 Firma y datos del firmante / Firma, dati concernenti il firmatario / Handtekening, omschrijving van de ondertekenaar

Glatten, 06.11.2012, 
 Wolfgang Schmalz
 Geschäftsführer / Managing Director / Directeur / Director Gerente / Direttore responsabile / Directeur



Visit us online:

Schmalz online – www.schmalz.com

These operating instructions were originally written in German and have been translated into English.

We reserve the right to make technical changes. No responsibility is taken for print errors or other types of errors.

All information and specifications are subject to change without notice.

© J. Schmalz GmbH. All rights reserved.

30.30.01.00016-EN

Last updated: 02/2017 / Index 02



Schmalz worldwide

Canada

Tel.+1 905 569 9520
Fax+1 905 569 8256
schmalz@schmalz.ca

China

Tel.+86 21 5109 9933
Fax+86 21 5039 8882
schmalz@schmalz.net.cn

Finland

Tel.+358 9 85746 92
Fax+358 9 85746 94
schmalz@schmalz.fi

France

Tel.+33 (0) 1 6473 1730
Fax+33 (0) 1 6006 6371
schmalz@schmalz.fr

India

Tel.+91 (0) 20 4072 5500
Fax+91 (0) 20 4072 5588
schmalz@schmalz.co.in

Italy

Tel.+39 0321 621510
Fax+39 0321 621714
schmalz@schmalz.it

Japan

Tel.+81 45 308 9940
Fax+81 45 308 9941
schmalz@schmalz.co.jp

Netherlands

Tel.+31 (0)74 255 5757
Fax+31 (0)74 255 5758
schmalz@schmalz.nl

Poland

Tel.+48 (0)22 46 04970
Fax+48 (0)22 87 40062
schmalz@schmalz.pl

Russia

Tel.+7 495 9671248
Fax+7 495 9671249
schmalz@schmalz.ru

Spain

Tel.+34 94 4805585
Fax+34 94 4807264
schmalz@schmalz.es

South Korea

Tel.+82 31 8162403
Fax+82 31 8162404
schmalz@schmalz.co.kr

Switzerland

Tel.+41 44 88875 25
Fax+41 44 88875 29
schmalz@schmalz.ch

Turkey

Tel.+90 216 3400121
Fax+90 216 3400124
schmalz@schmalz.com.tr

USA

Tel.+1 919 7130880
Fax+1 919 7130883
schmalz@schmalz.us