

Innovative Vacuum for Automation

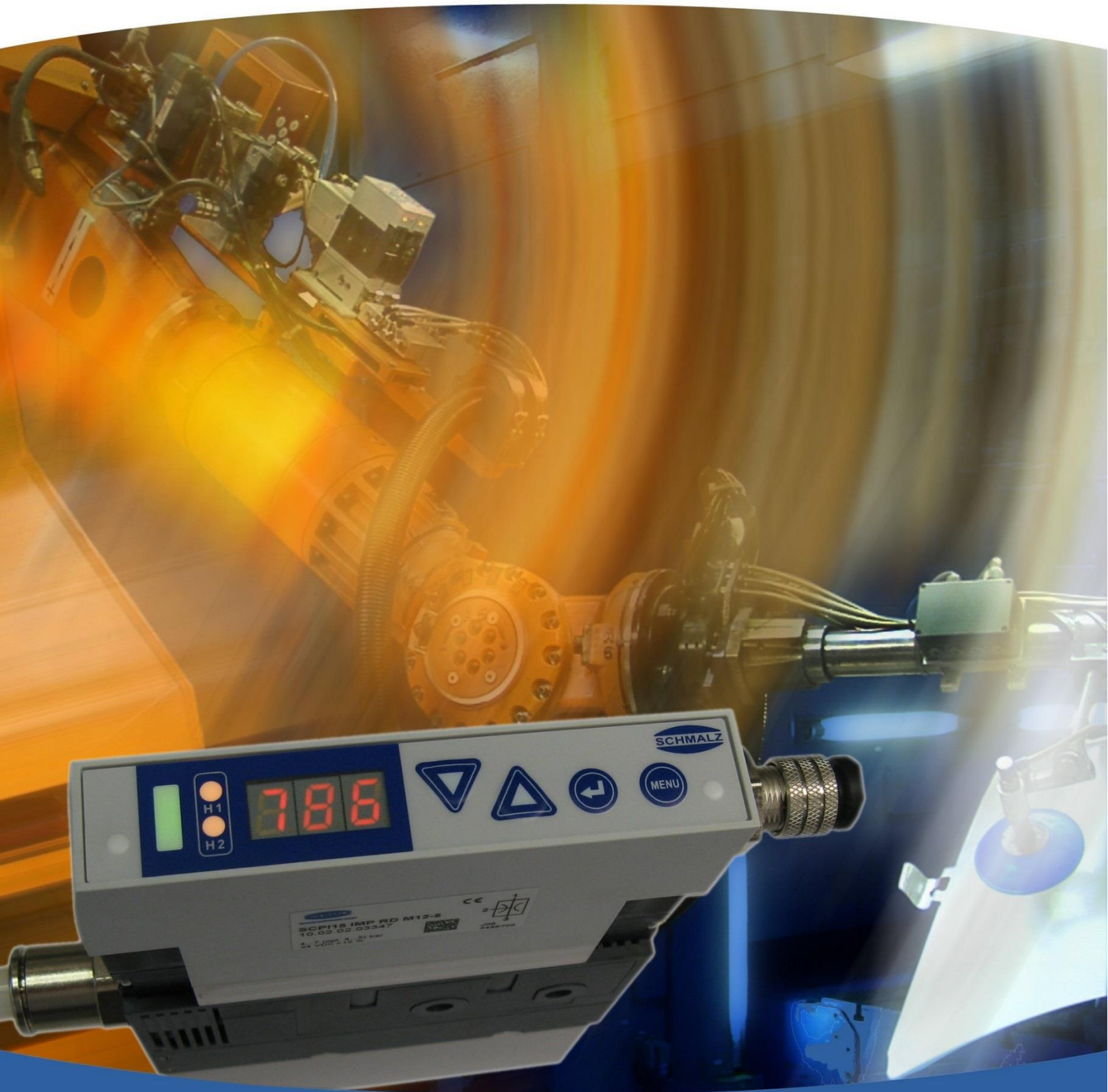

Operating instructions
30.30.01.00078

EN
SCPi / SMPi

CONTENTS

1	Safety instructions	1-4
	Important symbols	1-4
	General safety information	1-4
	Intended use.....	1-5
2	Start-up.....	2-6
	Installation and operation	2-6
	Electrical connection	2-7
	Pneumatic connection	2-7
	Setting the blow-off volume flow	2-8
3	Description.....	3-8
	Version overview	3-8
	Ejector design.....	3-9
	Operating and display elements.....	3-10
	General function description.....	3-11
	Operating modes	3-13
	Control concept for IMP ejectors	3-14
	Status display for system vacuum.....	3-15
	Valve LEDs.....	3-17
	Monitoring of the valve switching frequency (valve protection func. dCS).....	3-17
4	Operating and menu concepts.....	4-18
	Menu authorisation.....	4-18
	Manual mode.....	4-19
	Basic menu	4-20
	Setting of switching points for the air-saving function with [H-1] and [h-1]	4-22
	Setting of switching points for the signal output with [H-2] and [h-2]	4-23
	Setting the blow-off time [tbL].....	4-24
	Zero-point adjustment (calibration) [CAL]	4-25
	Counters, software versions and serial numbers	4-26
	Cycle counters [ct1] and [ct2].....	4-27
	Displaying the cycle counters.....	4-27
	Software version [SoC].....	4-28
	Serial number [Snr]	4-28
	Configuration menu	4-29
	Configuration of the vacuum unit [uni].....	4-31
	Configuration of the signal type [tyP]	4-31
	Configuration of the signal output [out]	4-32
	Configuration of the air-saving function [ctr].....	4-32
	Configuration of the blow-off function [bLo].....	4-33
	Rotating the display screen [dPy].....	4-34
	Locking the menus using a PIN code [Pin]	4-35
	Resetting to the factory settings (Clear All) [rES].....	4-36
5	Maintenance.....	5-37
	Spare and wearing parts	5-38
	Accessories	5-38

6	Errors.....	6-39
	Troubleshooting.....	6-39
	Error codes.....	6-39
7	Technical data	7-40
	Electrical data	7-40
	Electrical connection	7-43
	Mechanical data.....	7-44
	Dimensions	7-45
	Pneumatic circuit plans	7-49
	Overview of display symbols	7-50
	Factory settings.....	7-51
8	Declaration of conformity.....	8-52
	54

1 SAFETY INSTRUCTIONS

Important symbols



This symbol identifies important information and instructions.



Caution!

This symbol identifies a potentially dangerous situation. If it is not avoided, slight or minor injuries may result.



Danger!

This symbol identifies an immediate hazard. If it is not avoided, death or serious injuries may result.

General safety information



- These operating instructions contain important information on using the ejector. Please read the operating instructions thoroughly and keep them for later reference.



Never look into any open or closed vacuum vents (e.g. vacuum connections or suction pads). Serious injuries could occur as a result. Eyes can be sucked in.

- Compressed air can cause closed containers to explode. A vacuum can cause closed containers to implode.
- The ejector may only be operated with a silencer. Never look into the exhaust air jet of the silencer.
- The ejector emits noise. We recommend wearing ear protection.
- This device is not intended for use with hazardous dust, oil mist, vapours or aerosols, etc. If drawn in, these materials will enter the exhaust air and may result in poisoning.

- Use only the connections, attachment holes and attachment materials that have been provided.
- Carry out mounting and removal only when the device is in a disconnected, depressurised state.
- Do not sit or stand in the area in which the picked-up payload is transported.
- Do not sit or stand in the danger area while the machine or system is in automatic mode.
- Components may be installed by trained specialist personnel only.
- Specialist personnel must be familiar with the most current safety rules and requirements. These apply to the use of such components as solenoid valves and pressure switches and to control units for devices, machines and systems, for example.
- Specialist personnel must also be familiar with the system's control concept. In particular, they must be familiar with the system's redundant control components and feedback signals.

Intended use

The ejector is designed for generating a vacuum for gripping and transporting objects when used with suction pads. Neutral gases in accordance with EN 983 are approved as media to be evacuated. Neutral gases include air, nitrogen, and inert gases (e.g. argon, helium and neon). Aggressive gases or media such as acids, acid fumes, bases, biocides, disinfectants or detergents are not permitted.



The ejector is **not** suitable to be used for the transportation or through-suction of liquids or bulk materials such as granulates.
Personal injury or damage to the ejector may otherwise occur.



The ejector must **not** be used to fill pressurised containers or to drive cylinders, valves or other pressure-operated function elements.
Personal injury or damage to the ejector may otherwise occur.

2 START-UP

Installation and operation

For safe installation and smooth operation, please observe and maintain the following points:



The ejector may only be operated via power supply units with protected extra-low voltage (PELV). The system must incorporate safe electrical cut-off of the power supply in compliance with EN60204.



**The device may not be operated in environments where there is a risk of explosion.
Risk of fire and explosion.**



The device may not be operated outside its specified capacities. Doing so may either cause the device to malfunction or destroy the device.



During installation and maintenance, make sure that the ejector is disconnected and depressurised and that it cannot be switched on again without authorisation. Personal injury or damage to the ejector may otherwise occur.

- Protect the ejector from being damaged at all times.
- No modifications may be made to the ejector.
- Connection symbols and designations are located on the ejector. These must be observed.
- Only the intended connections may be used.
- Pneumatic and electrical line connections must be securely connected and attached to the ejector.
- The ejector may be installed in any position.
- If these notices are not observed, then malfunctions, material damage and serious injury – including fatal injury – could occur as a result.
- If the ejector is no longer operative, the components must be disposed of in an ecologically sound manner.

Electrical connection

- The electrical connection of the ejector is made using a 5-pin or 8-pin M12 male connector. The pin assignment is described in the “Technical data” chapter.
- The plug connectors may not be connected or disconnected when the system is live.
- The ejector may only be operated via power supply units with protected extra-low voltage (PELV). The system must incorporate safe electrical cut-off of the power supply in compliance with EN60204.
- The power supply, signal inputs and signal outputs have a maximum line length of 30 metres.

Pneumatic connection

- Use only well maintained compressed air (air or neutral gas according to EN 983, filtered 40 µm, oiled or unoled).
- High quality compressed air is important for the prolonged service life of the ejector.
- Dirt particles or foreign bodies in the ejector connections, hoses or pipelines can lead to partial or complete ejector malfunction.
- Hoses and pipelines should be laid as short as possible.
- Insufficient compressed air is supplied if the internal diameter on the compressed air side is too small. This prevents the ejector from performing as specified in its defined performance data.
- Excessive flow resistance occurs if the internal diameter on the vacuum side is too small. This leads to both a reduction in suction power and increased suction times. Blow-off times are also lengthened.
- Hose lines must be laid without bends and crimps.
- Only use the hose or pipe internal diameters recommended for the ejector. If this is not possible, use the next largest internal diameter.

Nozzle size	Line cross-section internal diameter ¹⁾	
	Compressed air side	Vacuum side
15 (1.5 mm)	6 mm	6 mm
20 (2.0 mm)	6 mm	8 mm
25 (2.5 mm)	8 mm	9 mm

¹⁾ Based on a maximum hose length of 2 m

Setting the blow-off volume flow

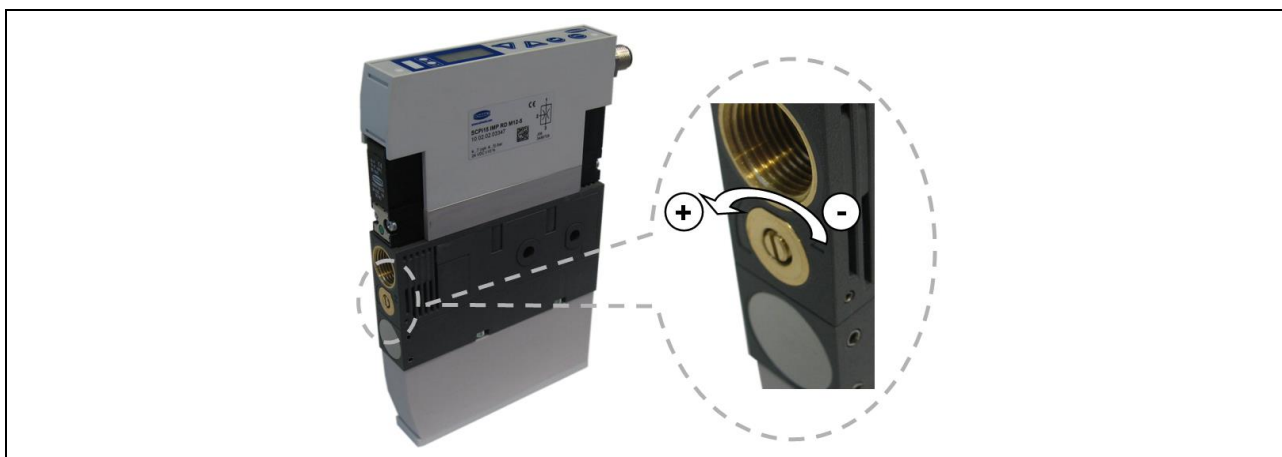

The valve screw for setting the blow-off volume flow is located underneath the vacuum connection. The volume flow is reduced by turning the valve screw clockwise and increased by turning it anti-clockwise. The valve screw is equipped with a stop on both sides.



Do not overwind the stop on the valve screw. A minimum volume flow of approx. 20% is always necessary for technical reasons.

The blow-off volume flow can be set between 20% and 100%.

3 DESCRIPTION

Version overview

The ejector is available in various different versions. Each version is defined by its item description, which can be identified as follows:

Type	Nozzle size	Idle position of suction valve	System monitoring	Electrical connection	Potential isolation
SCPi without power blow-off	15 1.5 mm	NO Open without current	VD Digital vacuum switch RD Digital vacuum switch and integrated air-saving function	M12-5 1xM12, 5-pin M12-8 1xM12, 8-pin	- No potential isolation PT With potential isolation
	20 2.0 mm	NC Closed without current			
SMPi with power blow-off	25 2.5 mm	IMP Bistable via pulse			

Ejector design

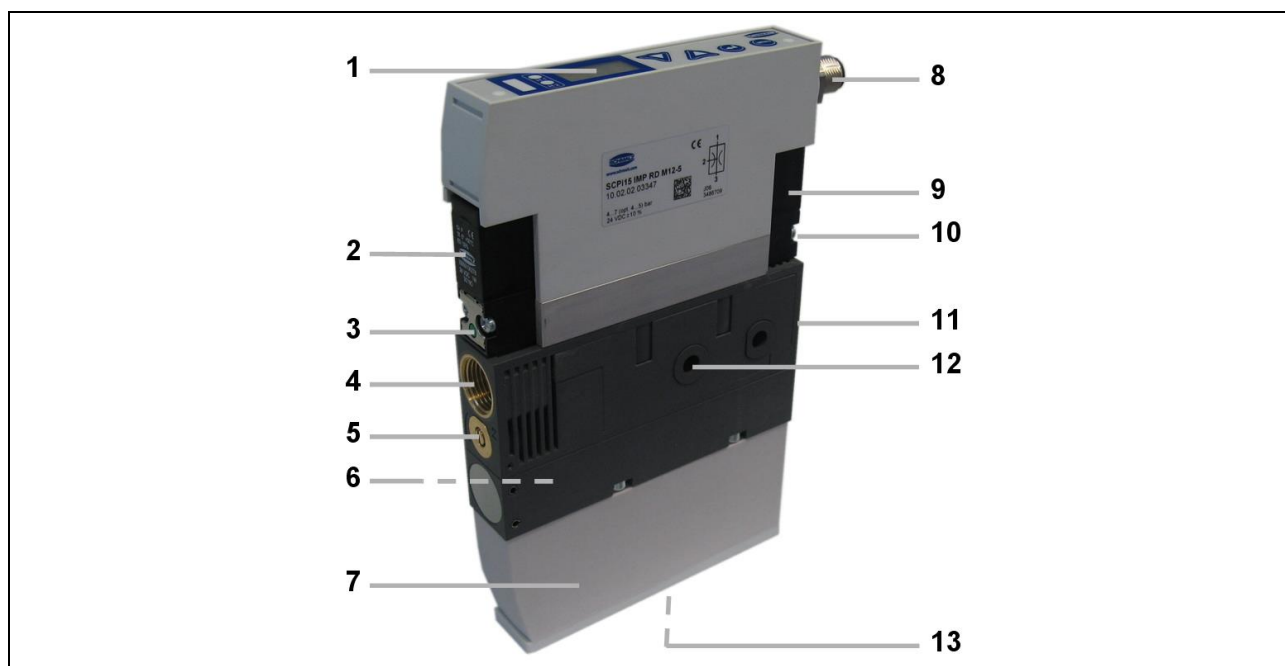

Item	Description	Max. torque
1	Operating and display element	
2	Blow-off valve ¹⁾	0,75 Nm
3	Manual operation button for blow-off valve	
4	Vacuum connection with 3/8" thread	10 Nm
5	Valve screw for blow-off volume flow	
6	Optional integrated power blow-off module for maximum blow-off volume flow (SMPi)	
7	Silencer	
8	Electrical M12 male connector (5-pin or 8-pin)	hand tight
9	Suction valve ²⁾	0,75 Nm
10	Manual operation button for suction valve ³⁾	
11	Compressed air connection with 1/4" thread	10 Nm
12	Ejector attachment	6 Nm
13	Fastening screw for silencer	1 Nm

¹⁾ Blow-off valve: All ejector versions: NC function (with NO pilot valve)





²⁾ Suction valve: NO ejector version: NC pilot valve
 NC ejector version: NO pilot valve
 IMP ejector version: pulse pilot valve

³⁾ Manual operation of the suction valve is only available on NO and NC ejectors.

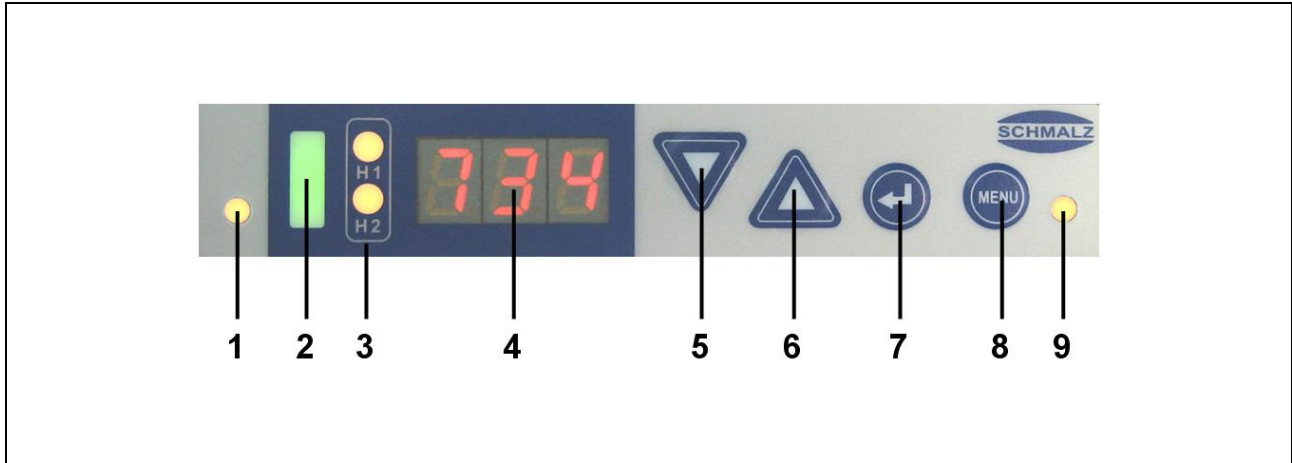
Operating and display elements

The ejector can be set and operated easily using the membrane keypad. The current vacuum and setting values are shown on the three-digit display.



Item	Description
1	LED for blow-off valve
2	Status display for system vacuum
3	H1 LED (air-saving function) and H2 LED (parts control signal output)
4	Display (3-digit/7-segment)
5	 DOWN button
6	 UP button
7	 ENTER button
8	 MENU button
9	LED for suction valve

General function description

VACUUM GENERATION (WORKPIECE PICK-UP)

The ejector is designed for handling parts using a vacuum together with suction systems.

The Venturi nozzle is activated and deactivated over the suction signal input. In NO versions, the Venturi nozzle is deactivated when the suction signal input is present. In NC versions, the Venturi nozzle is activated when the suction signal input is present. On IMP versions, the suction signal input is evaluated for its pulse. This means that suction mode is activated on the ejector when an pulse of at least 50 ms is present. A longer pulse does not affect functionality.

An integrated sensor records the vacuum generated by the Venturi nozzle. This is evaluated by an electronics system and forms the basis of the system status display.

The ejector is available with (RD ejectors) and without (VD ejectors) the air-saving function. On versions with the air-saving function, the ejector automatically regulates the vacuum when in suction mode. The electronics system switches the Venturi nozzle off when the H1 switching point set by the user is reached.



The set switching point H1 might be exceeded considerably before the vacuum is switched off when small volumes are to be evacuated. This system behaviour does not constitute an error.

When objects with solid surfaces are picked up, the integrated non-return valve prevents the vacuum from dropping. If the system vacuum drops below the switching point [H1-h1] due to leaks, the Venturi nozzle is switched back on.

On ejectors with a pulse valve (IMP) the ejector maintains the suction mode when the power supply fails during automatic mode. This prevents picked up objects from falling off the suction pad in the event of a power supply failure. This also applies when the ejector was set to "Venturi nozzle inactive" with air-saving mode activated. In this case, the ejector switches to "Venturi nozzle active" (i.e. continuous suction). The energy required to actuate the suction valve (pulse valve) is supplied here by integrated capacitors. When the power supply returns, the ejector remains in automatic mode with activated air-saving function. If the ejector is in blow-off mode when the power supply fails, then the blow-off is stopped and the ejector is set to "Pneumatically OFF". This saves unnecessary compressed air consumption and saves energy and additional costs. When the power supply returns, the ejector remains in the "Pneumatically OFF" state.

The power supply is monitored by the electronics system. If the power supply drops below approximately 21 V, then the air-saving function is deactivated. The suction and blow-off signal inputs are also no longer processed.

On NO and NC ejectors, the suction valve is also equipped with a manual mode button. The valve can then be actuated manually without a power supply.

BLOW-OFF (DEPOSITING THE WORKPIECE)

In blow-off mode, the vacuum circuit of the ejector is supplied with compressed air. This ensures that the vacuum drops quickly and the workpiece is deposited quickly. The blow-off mode can be controlled externally or internally.

When controlled externally, the blow-off mode is activated through the blow-off signal input.

When controlled internally (automatic blow-off), the blow-off valve is controlled for a defined period after suction mode is exited. Ejector version IMP does not have this function.

Suction mode is simultaneously switched off through the blow-off signal input.

If the suction signal input is still present following the blow-off status on pulse-controlled ejectors (IMP), then this is not evaluated. The ejector only switches to suction mode after another pulse.

The blow-off valve is also equipped with a manual mode button. Using the manual mode button, the valve can be set to blow-off mode without a power supply.



The ejector must not be operated with a closed vacuum connection. Personal injury or damage to the ejector may otherwise occur.



The ejector also has a manual mode. In this mode, the ejector can be controlled using the buttons on the membrane keypad. See the “Manual mode” chapter for more details.

Operating modes

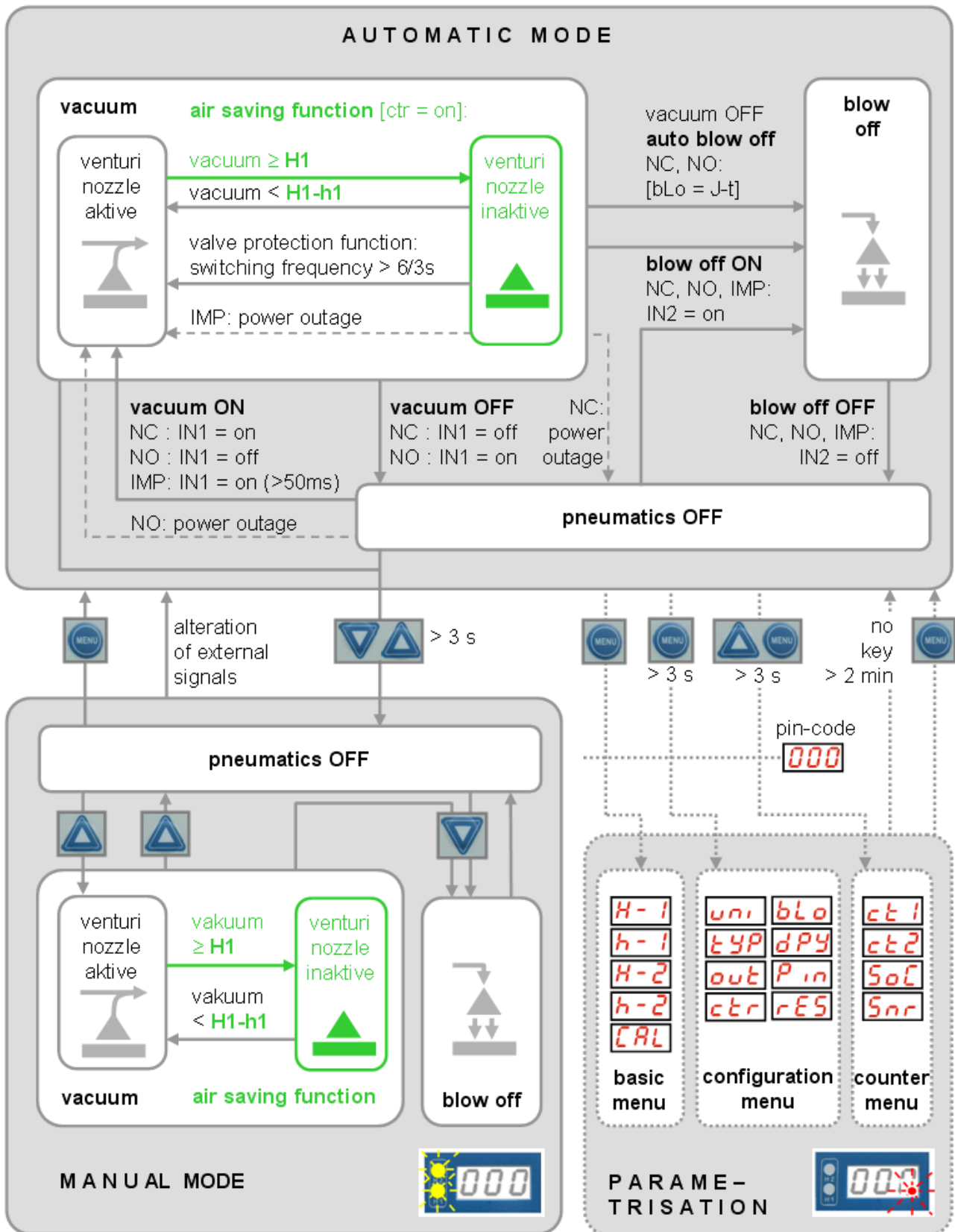

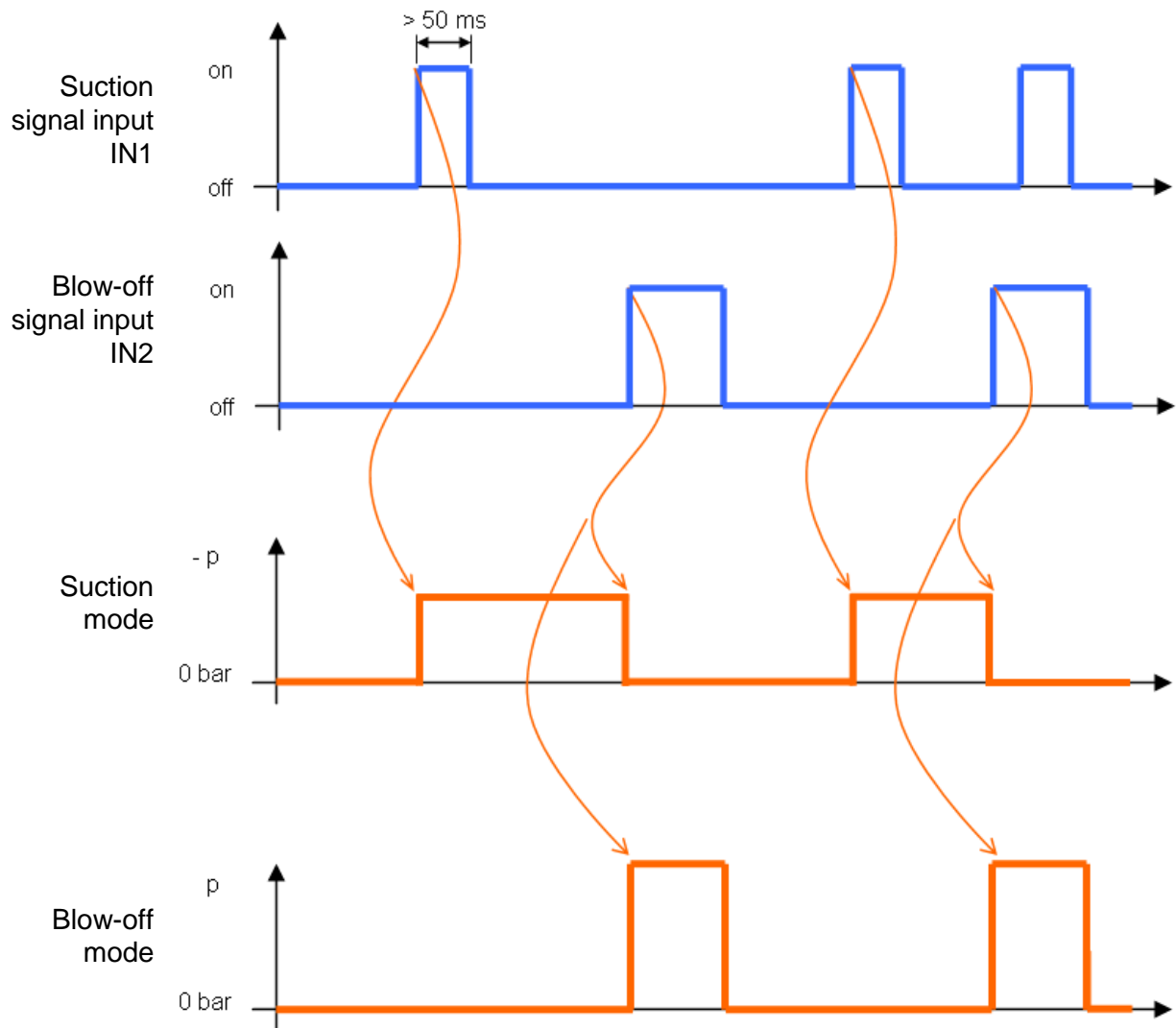
Control concept for IMP ejectors

IMP ejectors are set to “Pneumatically OFF” on delivery. The ejector only starts the suction procedure after a valid pulse is sent through the suction signal input.

Status display for system vacuum

The ejector is equipped with a status display for the system vacuum and monitoring functions. System states are indicated in **RED** or **GREEN**. The status display is updated after every suction cycle that is activated (NC/IMP) or deactivated (NO) over the suction signal input.

On conventional suction cycles, the status display is used to display the system vacuum level based on the H1 switching point. The status display goes out after a conventional suction cycle is finished.

VACUUM MONITORING

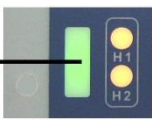
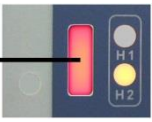
Status display	Vacuum monitoring
GREEN 	Rising vacuum: Vacuum \geq H1 Falling vacuum: Vacuum \geq H1-h1
RED 	Vacuum < H1

MONITORING FUNCTIONS

If the H1 switching point is never reached within a suction cycle, then the status display remains **RED**, even after the cycle is finished.

Ejectors with air-saving functions (RD) are equipped with a valve protection function. With the air-saving function activated [**ctr=on**] and high leakage rates in the gripper system, the ejector switches constantly between the “Venturi nozzle active” and “Venturi nozzle inactive” states. The number of valve switching procedures thus increases rapidly within a short space of time. In order to protect the ejector and increase its service life, the ejector switches the air-saving function off automatically at a switching frequency of > 6/3 seconds and activates continuous suction (i.e. the ejector then remains in the “Venturi nozzle active” state). The status display remains **RED** until the next suction cycle.

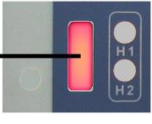
Status display	Monitoring function	Reaction of ejector
RED 	H1 never exceeded in suction cycle	-
	Suction valve switches > 6/3 seconds (RD ejectors)	Ejector is set to continuous suction (i.e. the ejector then remains in the “Venturi nozzle active” state - valve protection function)

STATUS DISPLAY OVERVIEW

Suction cycle with H1 reached

VD ejectors
RD ejectors: **[ctr=on]** and no leakage or **[ctr=off]**

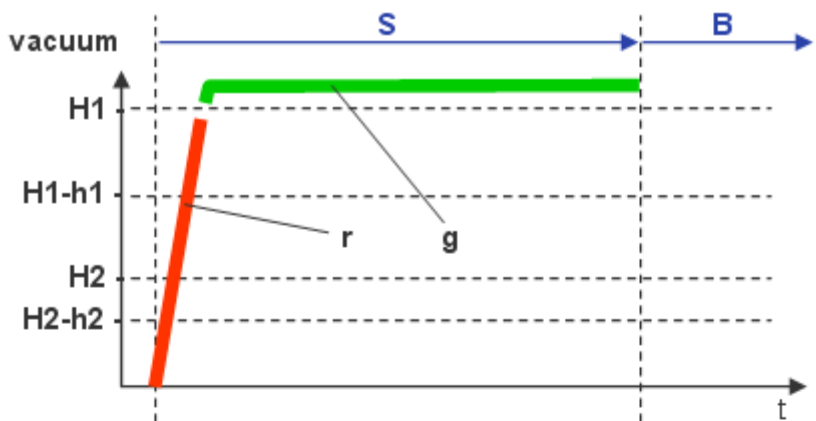

Suction cycle with vacuum-regulation (air-saving function)

RD ejectors: **[ctr=on]**

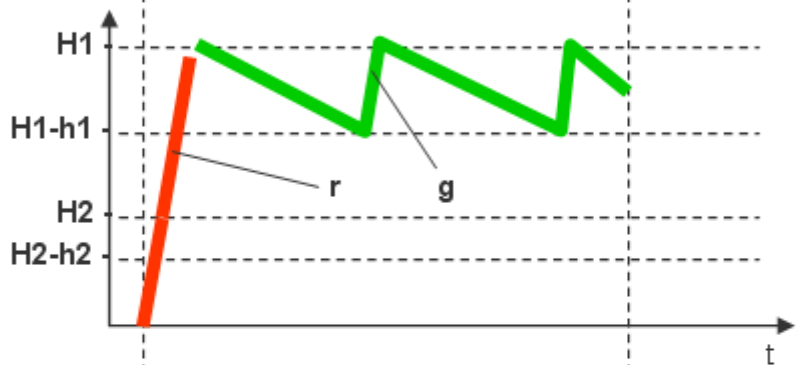

Suction cycle with vacuum-regulation (air-saving function) where the valve protection function was activated

RD ejectors: **[ctr=on]**

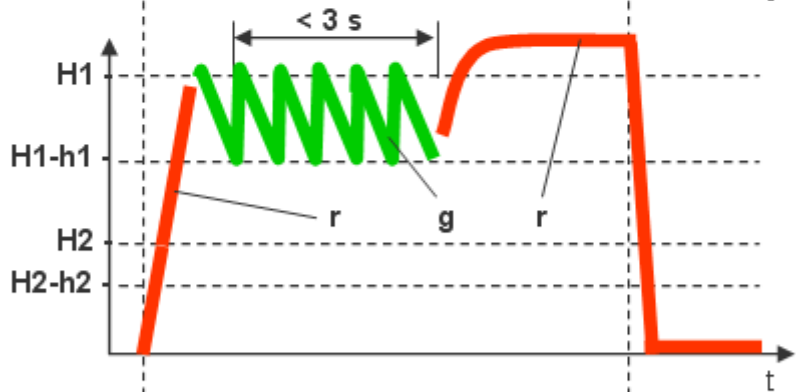

Suction cycle where H1 is never exceeded

VD ejectors
RD ejectors

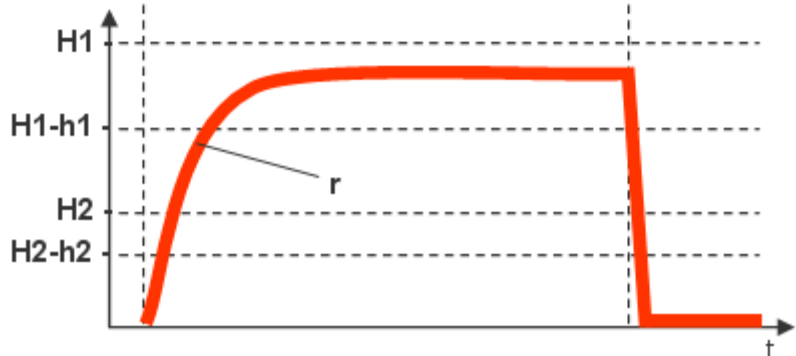



Key:

- S: Vacuum ON
- B: Vacuum OFF, blow off ON
- r: RED
- g: GREEN

Valve LEDs

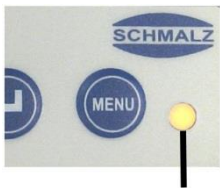
The suction and blow-off valves are each assigned an LED.

LED	LED state	Ejector state
 <p>Suction valve</p>	LED is continuously lit	NO: No suction on ejector NC: Suction on ejector IMP: Suction on ejector
 <p>Blow-off valve</p>	LED is continuously lit	Ejector blows off

Monitoring of the valve switching frequency (valve protection func. dCS)

If the air saving function triggers the suction valve more than six times within three seconds, then the ejector is set to continuous suction (i.e. it remains in the “Venturi nozzle active” state). The status display turns **RED**. This indicates the valve protection function. This remains in place until the next suction cycle begins.

DEACTIVATING THE VALVE PROTECTION FUNCTION (dCS)

This function deactivates the automatic control shutoff caused by the valve protection function.

The function can be set via the configuration menu under the **[dCS]** menu item or via IO-Link.

If the function **[dCS = NO]** is selected, the ejector switches to the “Continuous suction” operating mode when the valve switches too frequently.

In the setting **[dCS = YES]**, continuous suction is deactivated and the ejector continues in control mode the valve despite a control frequency greater than 6/3s.



Deactivating the control shutoff function **[dCS = YES]** can lead to high frequency switching of the suction valve.
This results in the risk of premature wear on the ejector.



The setting **[dCS = YES]** is only possible when the control function **[ctr = on]** is set.



In the case of undervoltage or power failure, the ejector switches to “Continuous suction” according to the particular ejector version (NO / NC / IMP), even if continuous suction was deactivated by the **[dCS = YES]** setting.

4 OPERATING AND MENU CONCEPTS

The unit is operated via four buttons on the membrane keypad. Settings are made using software menus. The operating structure is divided into settings in the basic menu and configuration menu. Setting of the ejector in the basic menu is sufficient for standard applications. An extended configuration menu is available for applications with special requirements.

The ejector is set to display mode when outside the menus. The current vacuum is displayed.







The unit of the current vacuum can be displayed by pressing the  button.

Menu authorisation

Menus can be protected against unauthorised access by defining a PIN code **[Pin]** in the configuration menu. **[Loc]** flashes in the display when the lock is active, or the PIN code is requested.

The menus are accessed as follows:

- Press the  button.
- Enter the first digit of the PIN code using the  or  buttons.
- Confirm by pressing the  button.
- Enter the remaining digits in the same way.
- Press the  button to activate the menus.

The lock is activated again automatically after the selected menu or function is exited. The PIN code “000” must be set for permanent deactivation of the lock.



The PIN code is set to “000” on delivery, meaning the menus are not locked.



If an incorrect PIN code is entered, then **[Loc]** is displayed and the menus remain locked.

If the correct PIN code has been lost, then the ejector must be sent back to the manufacturer for authorisation.

Manual mode



The output signals may change during set-up in manual mode. Ensure that the machine or system does not start moving as a result. Personal injury or damage to the ejector could occur as a result.

Manual mode can be used for locating and eliminating leakage. The ejector can be controlled manually using the buttons on the membrane keypad. In this operating mode, the H1 and H2 LEDs both flash.

ACTIVATING MANUAL MODE



Activate manual mode as follows:

- Press and hold the  and  buttons together for more than 3 seconds.



Manual mode can be used even if actuator voltage is not present (emergency stop, setup mode).

MANUAL SUCTION

The suction mode is activated in manual mode by pressing the  button. The suction mode is exited by pressing the  button again or by pressing the  button.



This is also active in manual mode when the air-saving function is activated **[ctr=on]** (RD ejectors). This applies even if actuator voltage is not present. Instead of the Error code **[E05]** the actual vacuum value is shown.



The valve protection function is not active in manual mode.

MANUAL BLOW-OFF

The blow-off mode is activated in manual mode by pressing the  button. The mode remains active as long as the button is pressed.



If actuator voltage is not present, manual blow-off mode is not available. Error code [E05] is displayed.

DEACTIVATING MANUAL MODE

Manual mode is exited from the “Pneumatically OFF” idle setting using the  button. Manual mode is also exited when the status of the external signal inputs is changed.



The automatic exiting of manual mode through changes to external signals can cause a handled object to move (suction or blow-off).

BASIC MENU

All settings for standard ejector applications can be made and observed using the basic menu.

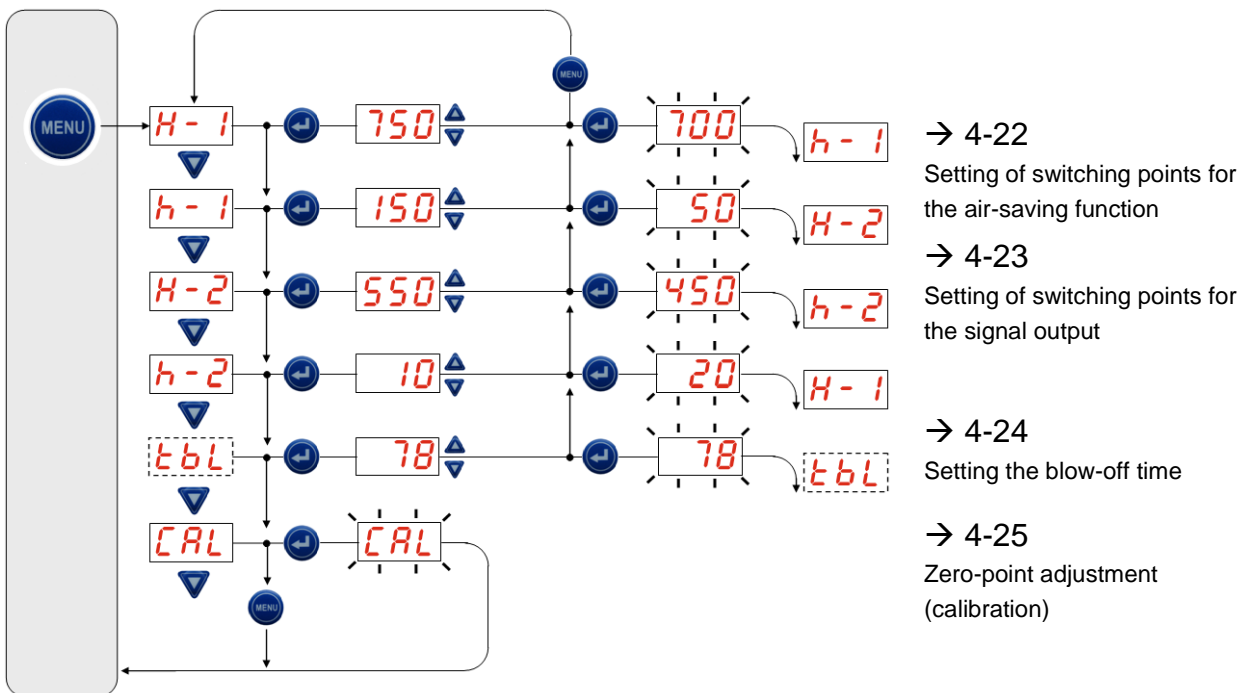

OVERVIEW OF SWITCHING POINTS

The ejector version with air-saving function is shown here (RD).

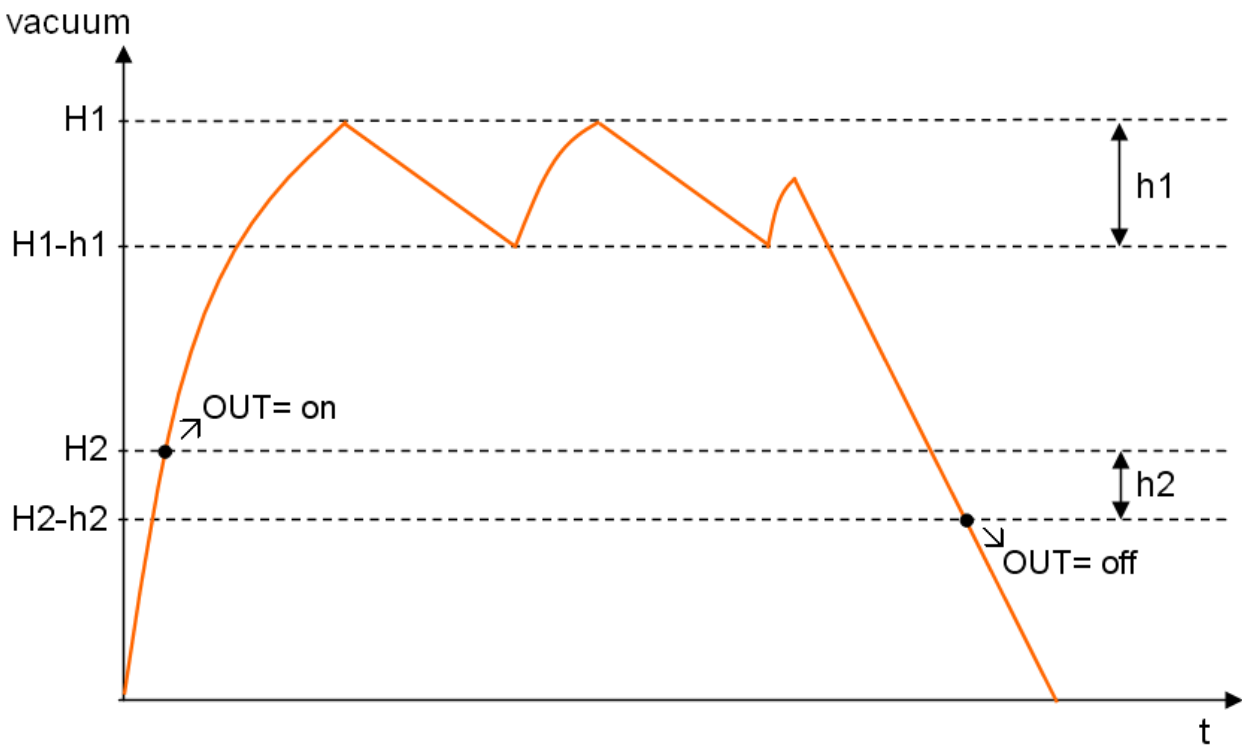

Value	Description
H1	Deactivation value for air-saving function
h1	Hysteresis of air-saving function
H1-h1	Activation value for air-saving function
H2	Activation value for parts control signal output ¹⁾
h2	Hysteresis of parts control signal output
H2-h2	Deactivation value for parts control signal output ¹⁾







¹⁾ Displayed when configuring the **[NO]** output.

Setting of switching points for the air-saving function with [H-1] and [h-1]

The deactivation value [H-1] and hysteresis [h-1] of the air-saving function are set using this function.



When the [H-1] deactivation value is reached or exceeded, then the H1 LED is also switched on.

The switching points of the air-saving function are set as follows:

- Press the  button.
- Enter a valid PIN if the menu is locked.
- Select the desired [H-1] or [h-1] parameter using the  or  buttons.
- Confirm by pressing the  button.
- Change the value using the  or  buttons.
- Press the  button to save the changed value.

The display automatically jumps to the next setting value.



When the  or  button is pressed for approx. 3 seconds, the value to be changed is scrolled through quickly.



The value is not accepted when exited using the  button.









The air-saving function is activated in the configuration menu with [ctr=on] and deactivated with [ctr=off].

Setting of switching points for the signal output with [H-2] and [h-2]

The activation value **[H-2]** (when configuring the **[no]** output) and hysteresis **[h-2]** of the parts control signal output are set using this function.



When the **[H-2]** value is reached or exceeded, then the H2 LED is also switched on.

The switching points of the parts control signal output are set as follows:

- Press the  button.
- Enter a valid PIN if the menu is locked.
- Select the desired **[H-2]** or **[h-2]** parameter using the  or  buttons.
- Confirm by pressing the  button.
- Change the value using the  or  buttons.
- Press the  button to save the changed value.

The display automatically jumps to the next setting value.



When the  or  button is pressed for approx. 3 seconds, the value to be changed is scrolled through quickly.



The value is not accepted when exited using the  button.









Changes to the configuration of the **[no]** or **[nc]** signal output are made in the configuration menu.

Setting the blow-off time [tbL]

If the blow-off function of the ejector is set to internally-controlled automatic blow-off **[blo= J-t]**, then the blow-off time **[tbL]** can be set. More information can be found in the chapter “Configuration of the blow-off function”.

The blow-off time is set as follows:

- Press the  button.
- Enter a valid PIN if the menu is locked.
- Select the **[tbL]** menu item using the  or  buttons.
- Confirm by pressing the  button.
- Set the desired blow-off time using the  or  buttons.
- Press the  button to save the changed value.



The blow-off time can only be set when the blow-off function is set to internally-controlled automatic blow-off **[blo= J-t]** in the configuration menu. This setting has no effect with ejector version IMP.







The displayed value indicates the blow-off time (in s). A blow-off time between 0,10 and 9,99 s can be set.

Zero-point adjustment (calibration) [CAL]



The vacuum circuit of the system must be ventilated to the outer atmosphere before zero-point adjustment is made.

A zero-point adjustment is made as follows:

- Press the  button.
- Enter a valid PIN if the menu is locked.
- Press  or  until [CAL] appears in the display.
- Confirm by pressing the  button.

After confirmation is made, the display flashes briefly and then returns automatically to display mode.



Zero-point adjustment is only possible at an area of $\pm 3\%$ from the final value of the measurement range. This means that the zero point can be adjusted by up to 30 mbar of vacuum, starting from the original zero point of the sensor.



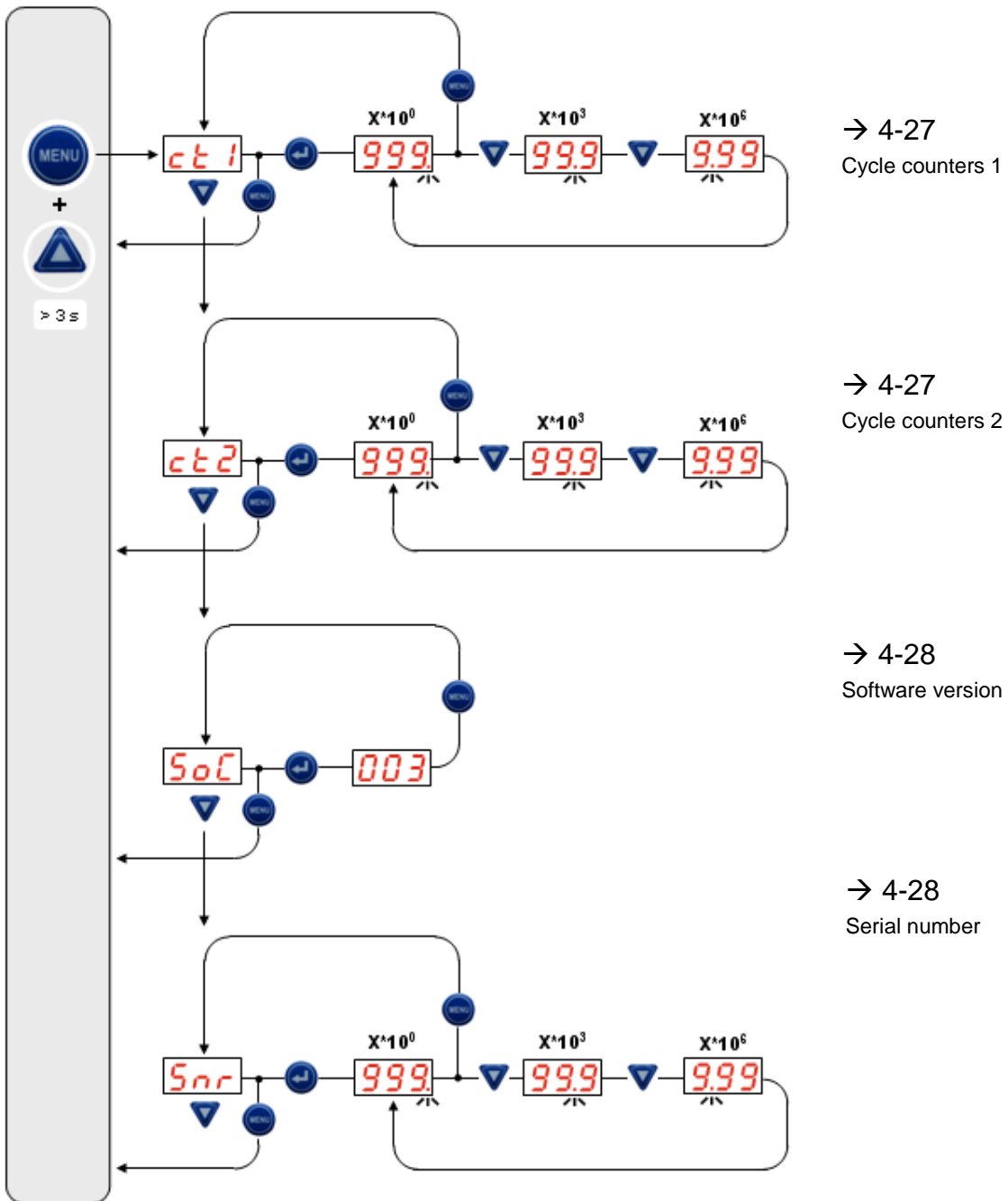

If the permissible limit of $\pm 3\%$ is exceeded, then the [E3] error code is shown in the display.

COUNTERS, SOFTWARE VERSIONS AND SERIAL NUMBERS







Cycle counters [ct1] and [ct2]

The ejector is equipped with two counters. Counter 1 is increased with each valid pulse on the suction signal input, and therefore counts the number of suction cycles in automatic mode. Counter 2 is increased with each switch of the suction valve. The switching frequency of the air-saving function can then be determined from the difference between counters 1 and 2.



Symbol	Function	Description
	Counter 1	Counter for suction cycles (suction signal input)
	Counter 2	Counter for valve switching frequency

Displaying the cycle counters



The cycle counters are displayed as follows:

- Press and hold the  and  buttons together for more than 3 seconds.
- Enter a valid PIN if the menu is locked.
- Select the desired [ct1] or [ct2] counter using the  or  buttons.
- Confirm by pressing the  button.

The final three decimal points of the complete counter value are displayed. The decimal point at the far right flashes. This corresponds to the three-digit block with the lowest perceived value.

The remaining decimal points of the complete counter value can be displayed using the  or  buttons. The decimal points show which three-digit block of the complete counter value is shown in the display.

The complete counter value is comprised of the three digit blocks together:

Displayed position	10^6	10^3	10^0
Digit block			

The current complete counter value in this example is 48 618 593.



Exit the counter function using the  button.

Software version [SoC]

The software version indicates the software currently running on the internal controller. The software version is displayed as follows:

- Press and hold the  and  buttons together for more than 3 seconds.
- Enter a valid PIN if the menu is locked.
- Press  or  until **[SoC]** appears in the display.
- Confirm by pressing the  button.







Exit the software version **[SoC]** using the  button.



Serial number [Snr]

The serial number indicates the production period.



The serial number is displayed as follows:

- Press and hold the  and  buttons together for more than 3 seconds.
- Enter a valid PIN if the menu is locked.
- Press  or  until **[Snr]** appears in the display.
- Confirm by pressing the  button.

The final three decimal points of the serial number are displayed. The decimal point at the far right flashes. This corresponds to the three-digit block with the lowest perceived value.

The remaining decimal points of the serial number can be displayed using the  or  buttons. The decimal points show which three-digit block of the serial number is shown in the display.

The serial number is comprised of the three digit blocks together:

Displayed position	10^6	10^3	10^0
Digit block			

The current serial number in this example is 48 618 593.



Exit the serial number **[Snr]** using the  button.

CONFIGURATION MENU

An extended configuration menu is available for applications with special requirements. The operating structure is as follows:

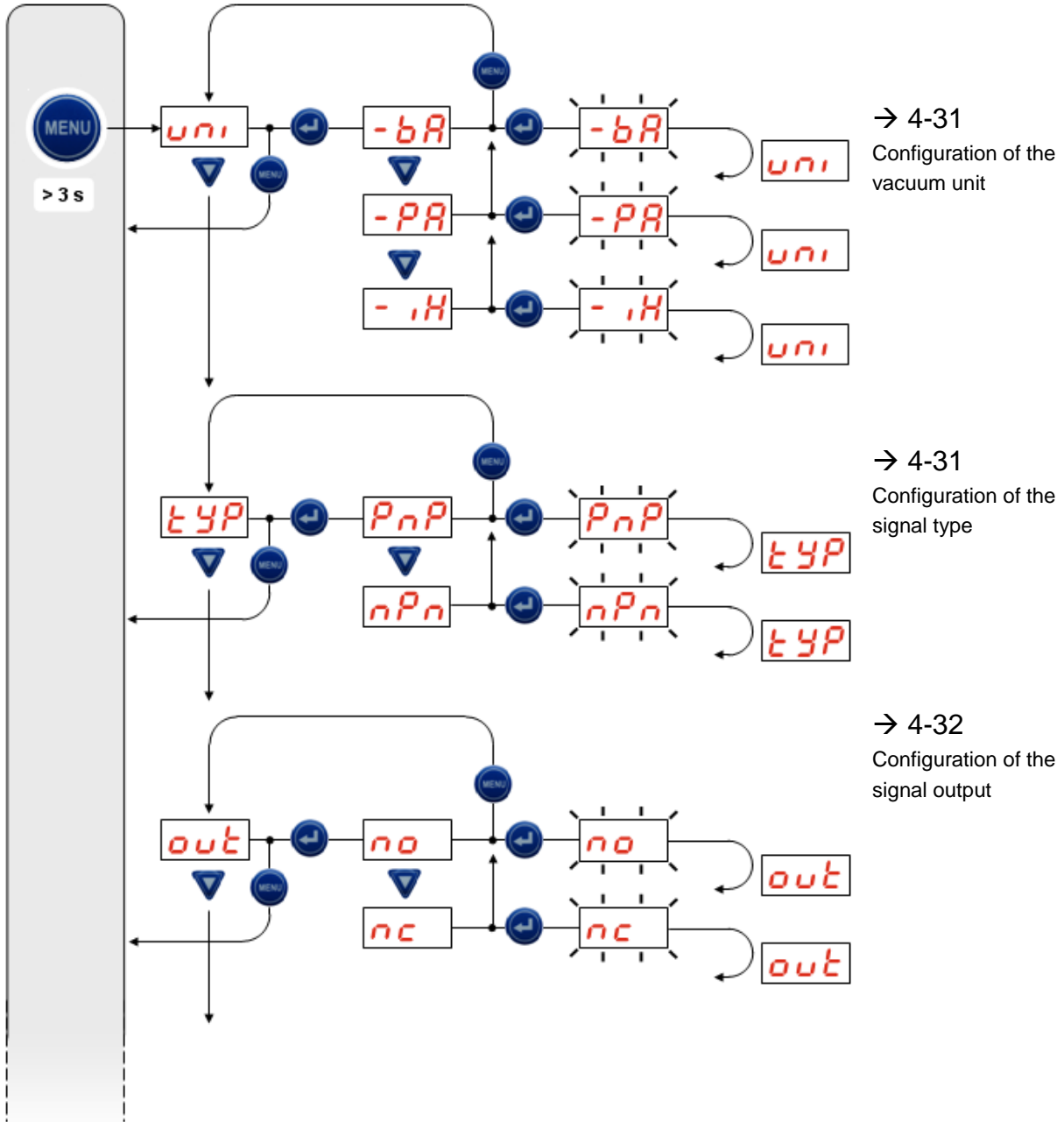

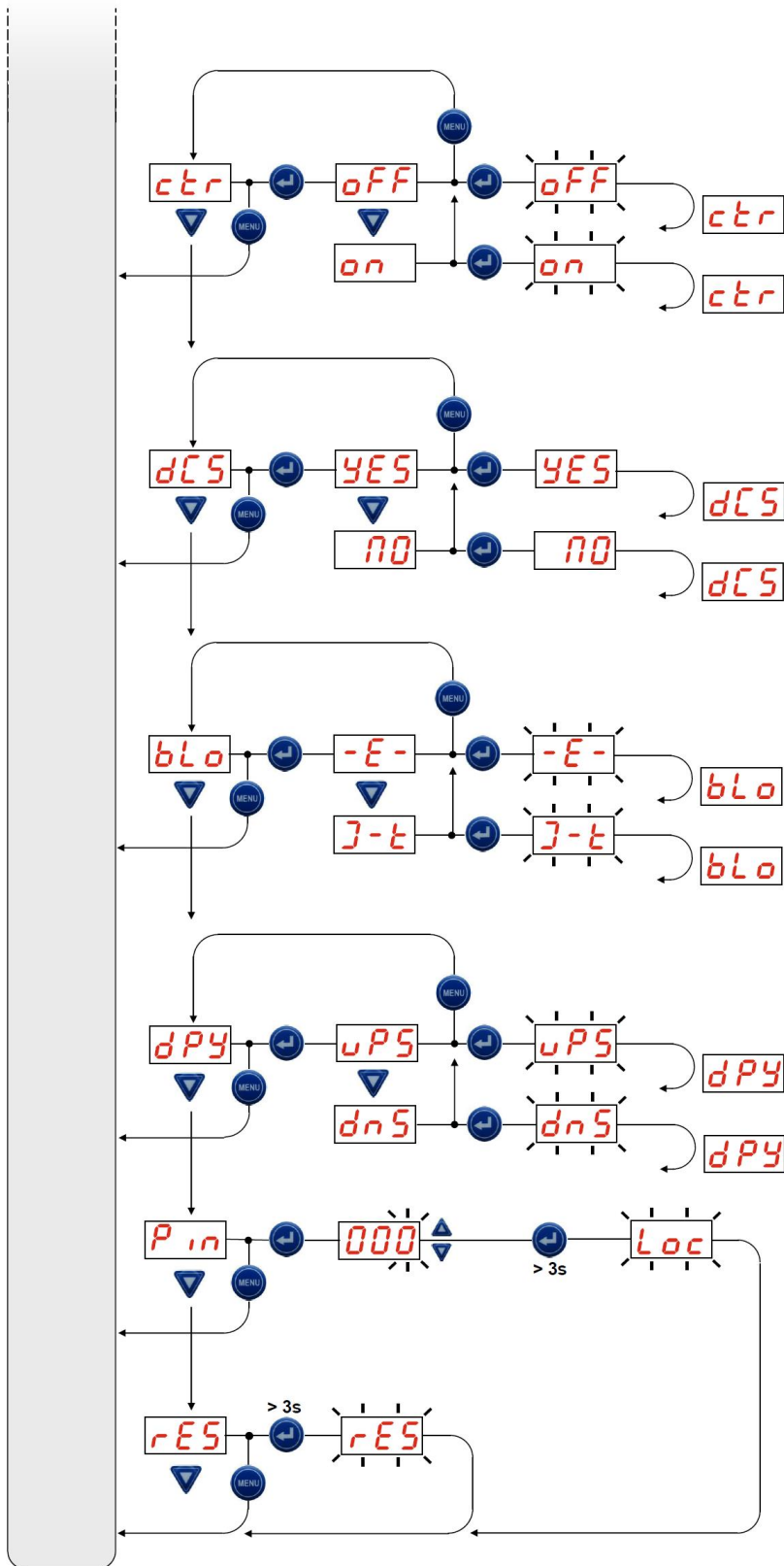

→ 4-32

Configuration of the air-saving function

→ 3-17

Valve Protection function

→ 4-33

Configuration of the blow-off function

→ 4-34

Configuration of the signal type

→ 4-35

Locking the menus using a PIN code







→ 4-36

Resetting to the factory settings (Clear All)

Configuration of the vacuum unit [uni]

The unit of the displayed vacuum can be set using this function.

The vacuum unit is set as follows:

- Press the  button for more than 3 seconds.
- Enter a valid PIN if the menu is locked.
- Select the **[uni]** menu item using the  or  buttons.
- Confirm by pressing the  button.
- Select the desired **[-bA]**, **[-PA]** or **[-iH]** unit using the  or  buttons.
- Confirm by pressing the  button.









[-bA]= mbar, **[-PA]**= kPa, **[-iH]**= inchHg

Configuration of the signal type [tyP]

This function is used to set the type of input and output signals.

The signal type is configured as follows:

- Press the  button for more than 3 seconds.
- Enter a valid PIN if the menu is locked.
- Select the **[tyP]** menu item using the  or  button.
- Confirm by pressing the  button.
- Select the desired **[PnP]** or **[nPn]** signal type using the  or  buttons.
- Confirm by pressing the  button.









The **[PnP]** or **[nPn]** signal type is defined together for all input and output signals.

Configuration of the signal output [out]

The parts control signal output can be switched between **[no]** (normally open) and **[nc]** (normally closed).

The parts control signal output is configured as follows:

- Press the  button for more than 3 seconds.
- Enter a valid PIN if the menu is locked.
- Select the **[out]** menu item using the  or  buttons.
- Confirm by pressing the  button.
- Select the desired **[no]** or **[nc]** function using the  or  buttons.
- Confirm by pressing the  button.









The setting of the corresponding switching point **[H-2]** and hysteresis **[h-2]** is made in the basic menu.

Configuration of the air-saving function [ctr]

This function is used to activate and deactivate the air-saving function.

The air-saving function is configured as follows:

- Press the  button for more than 3 seconds.
- Enter a valid PIN if the menu is locked.
- Select the **[ctr]** menu item using the  or  buttons.
- Confirm by pressing the  button.
- Select the desired **[on]** or **[oFF]** function using the  or  buttons.
- Confirm by pressing the  button.



The setting of the corresponding switching point **[H-1]** and hysteresis **[h-1]** is made in the basic menu.



The **[on]** function cannot be selected on VD ejectors.







Configuration of the blow-off function [bLo]

This configuration is used to select one of two blow-off functions:

Externally controlled blow-off [-E-]: The blow-off valve is controlled via the blow-off signal input.

Internally controlled automatic blow-off [blo= J-t]: The blow-off valve is controlled automatically for the time period [tbL] after exiting the suction mode. This function makes it possible to save an output on the controller.

The blow-off function is configured as follows:

- Press the  button for more than 3 seconds.
- Enter a valid PIN if the menu is locked.
- Select the [bLo] menu item using the  or  button.
- Confirm by pressing the  button.
- Select the desired [-E-] or [J-t] function using the  or  button.
- Confirm by pressing the  button.



The length of the blow-off time [tbL] is set in the basic menu.



The [J-t] function is not available on ejectors with pulse valves.









The blow-off signal input is not evaluated with the [J-t] function.



Rotating the display screen [dPy]

The display screen can be rotated by 180°.

Rotate the display screen as follows:

- Press the  button for more than 3 seconds.
- Enter a valid PIN if the menu is locked.
- Select the **[dPy]** menu item using the  or  buttons.
- Confirm by pressing the  button.
- Select the desired **[uPS]** or **[dnS]** function using the  or  buttons.
- Confirm by pressing the  button.



The function of the  and  buttons also changes together with the display screen. The Down button becomes the Up button. The decimal points of the display are shown on the top edge of the screen.



The factory setting is **[uPS]**. This corresponds to the standard configuration.









Locking the menus using a PIN code [Pin]

Menus can be protected against unauthorised access by defining a PIN code [Pin].



The PIN code is set to “000” on delivery, meaning the menus are not locked. A valid PIN code between 001 and 999 must be entered in order to activate the menu lock.

Activate the menu lock as follows:

- Press the  button for more than 3 seconds.
- Enter a valid PIN if the menu is locked.
- Select the [Pin] menu item using the  or  buttons.
- Confirm by pressing the  button.
- Enter the first digit of the PIN code using the  or  buttons.
- Confirm by pressing the  button.
- Enter the remaining digits in the same way.
- Press the  button for more than 3 seconds to save the PIN code.

[Loc] flashes in the display and the configuration menu is exited. The menus are now locked.



The PIN code “000” must be set for permanent deactivation of the lock.







The state of signal inputs and outputs can be changed in parameterisation mode. Accidental starting of the machine or plant could occur as a result. Therefore, use the possibility of locking with a PIN code [Pin].

Resetting to the factory settings (Clear All) [rES]

This function is used to reset the ejector to its factory settings.



All switching points and configurations are reset to the factory settings. The counters are not affected by this function.

- Press the  button for more than 3 seconds.
- Enter a valid PIN if the menu is locked.
- Select the [rES] menu item using the  or  buttons.
- Press the  button for more than 3 seconds to reset to the factory settings.

After confirmation is made, the display flashes briefly and then returns automatically to display mode.

The factory settings of the ejector can be found in the appendix.



The zero-point adjustment is also reset. The zero point may need to be set again [CAL].



The switching points and configuration of the signal output are changed by resetting to the factory settings. The signal on the signal output may change as a result.

5 MAINTENANCE

GENERAL MAINTENANCE

Remove dirt from the outside of the ejector by cleaning with a soft cloth and soap suds (max. 60 °C). Ensure that the silencer and the controller are not soaked with soap suds.

SILENCER MAINTENANCE

The silencer can become very dirty from the increased effects of dust, oil or chips. This can reduce the suction power. The silencer should be replaced in this case. Cleaning is not recommended due to the capillary effect of the porous material.

The ejector must only be operated with a silencer in order to avoid impermissible noise levels.

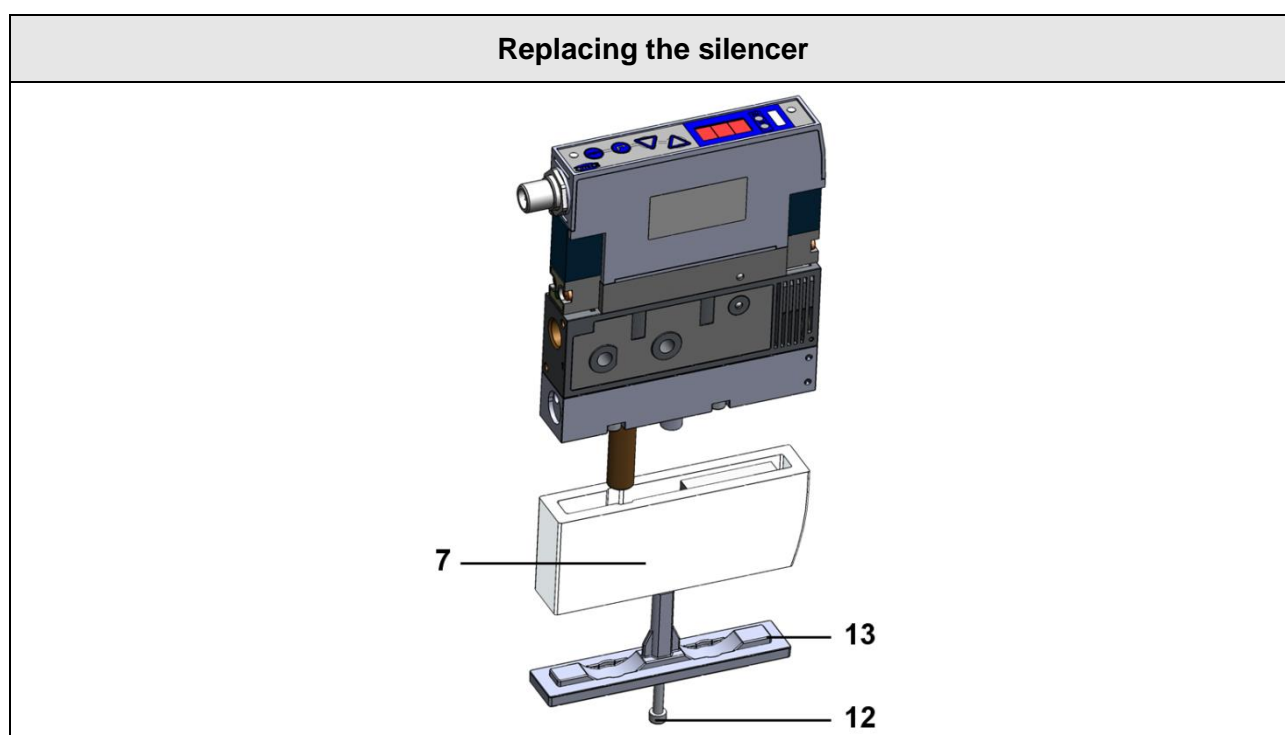

Step	Description
1	Loosen the fastening screw on the silencer [7] and cover [13] – Keep the screw and O-ring [12] in a safe place.
2	Remove the silencer [7] and cover [13].
3	Attach the new silencer (item no. 10.02.02.03381) and cover [13].
4	Reattach the fastening screw and O-ring [12] and tighten. Maximum torque = 1 Nm.

WARRANTY, SPARE AND WEARING PARTS

This ejector is guaranteed in accordance with our general terms of sale and delivery. The same applies for spare parts, provided that these are original parts supplied by us.

We fully exclude liability for any damages arising from use of spare parts or accessories that are not original parts or accessories.

Wearing parts are not covered by the warranty.

Parts are divided into the following types:

- E ...** Spare part
- V ...** Wearing part
- VB ...** Wearing part assembly

Spare and wearing parts

Type	Designation	Item no.	
	Silencer	10.02.02.03381	V
... NO ...	Suction valve for NO ejector (NC valve)	10.05.01.00277	E
... NC ...	Suction valve for NC ejector (NO valve)	10.05.01.00278	E
... IMP ...	Suction valve for IMP ejector (pulse valve) 1W	10.05.01.00280	E
... IMP ...	Suction valve for IMP ejector (pulse valve) 2,3W	10.05.01.00279	E
	Blow-off valve (NO valve)	10.05.01.00278	E



Observe a maximum torque of 0.75 Nm when tightening the valve fastening screws.

Accessories

Designation	Max. torque	Item no.
M12 connection cable, 8-pin	Hand-tight	21.04.05.00079
M12 connection cable, 5-pin	Hand-tight	21.04.05.00080
GP2 compressed air connection plate	5 Nm	10.02.02.00917
GP3 compressed air connection plate	5 Nm	10.02.02.00918
GP4 compressed air connection plate	5 Nm	10.02.02.00919
GP5 compressed air connection plate	5 Nm	10.02.02.00920
GP6 compressed air connection plate	5 Nm	10.02.02.00921
Ejector dummy plate ¹⁾	5 Nm	10.02.02.00728
Quick-change connection ²⁾	10 Nm	10.02.02.03463

¹⁾ Dummy plate for covering unused connections when using compressed air connection plates.

²⁾ For additional rapid-mounting function (tool-free replacement of ejectors).
When using with compressed air connection plates, order 1x per ejector.

6 ERRORS

Troubleshooting

Fault	Possible cause	Solution
Vacuum level is not reached or vacuum is created too slowly	Silencer is soiled	Replace silencer
	Leakage in hose line	Check hose connections
	Leakage on suction pad	Check suction pad
	Operating pressure too low	Increase operating pressure (observe max. limits)
	Internal diameter of hose line too small	See recommended hose diameters
Payload cannot be held	Vacuum level too low	Increase the control range of the air-saving function.
	Suction pad too small	Select a larger suction pad
Display shows an error code	See "Error codes" table	-

Error codes

Symbol	Error code
E01	Electronics error
E03	Zero-point adjustment outside $\pm 3\%$ FS
E05	Actuator supply undervoltage (display alternates with current vacuum value)
E06	Manual mode not possible during blow-off mode
E07	Actuator/sensor supply undervoltage
E12	Short circuit on OUT signal output
FFF	Present vacuum exceeds the measurement range
-FF	Overpressure in vacuum circuit



The **[E01]** error remains in the display after being shown once. Delete the error by switching off the power supply. If this error occurs again after the power supply is switched back on, then the device must be replaced.

7 TECHNICAL DATA

ELECTRICAL DATA



Operating the ejector system outside of the specified values can result in damage to the system and attached components.

ELECTRICAL PARAMETERS

Parameter	Symbol	Limit values			Unit	Comment
		min.	typ.	max.		
Power supply (M12-5)	U_{SA}	22,8	24	26.4	V DC	PELV ¹⁾
Power supply for sensor (M12-8-PT)	U_S	22,8	24	26.4	V DC	PELV ¹⁾
Power supply for actuator (M12-8-PT)	U_A	22,8	24	26.4	V DC	PELV ¹⁾
Nominal current NO (M12-5)	I_{SA}	—	155	—	mA	No signal output
Nominal current NC (M12-5)	I_{SA}	—	113	—	mA	No signal output
Nominal current IMP (M12-5)	I_{SA}	—	123	209 ²⁾	mA	No signal output
Nominal current sensor NO/NC (M12-8-PT)	I_S	—	155	—	mA	No signal output
Nominal current sensor IMP 1W (M12-8-PT)	I_S	—	76	113 ²⁾	mA	No signal output
Nominal current sensor IMP 2,3W (M12-8-PT)	I_S	—	81	167 ²⁾	mA	No signal output
Nominal current actuator NO (M12-8-PT)	I_A	—	108	—	mA	
Nominal current actuator NC (M12-8-PT)	I_A	—	66	—	mA	
Nominal current actuator IMP (M12-8-PT)	I_A	—	76	162 ²⁾	mA	
Voltage of signal output (PNP)	U_{OH}	$U_{S/SA}-2$	—	$U_{S/SA}$	V DC	$I_{OH} < 150$ mA
Voltage of signal output (NPN)	U_{OL}	0	—	2	V DC	$I_{OL} < 150$ mA
Current of signal output (PNP)	I_{OH}	—	—	150	mA	Secured against short-circuits ³⁾
Current of signal output (NPN)	I_{OL}	—	—	-150	mA	Secured against short-circuits ³⁾
Voltage of signal input (PNP)	U_{IH}	15	—	$U_{A/SA}$	V DC	Based on Gnd_S
Voltage of signal input (NPN)	U_{IL}	0	—	9	V DC	Based on U_S
Current of signal input (PNP)	I_{IH}	—	5	10	mA	
Current of signal input (NPN)	I_{IL}	—	-5	-10	mA	
Pulse length for suction valve	t_P	50	—	—	ms	
Reaction time of signal inputs	t_i	—	15	—	ms	
Reaction time of signal output	t_o	—	2	—	ms	

¹⁾ The power supply must correspond to the regulations in accordance with EN60204 (protected extra-low voltage). The power supply, signal inputs and outputs are all protected against reverse polarity.

²⁾ Repetitive peak forward current lasting 60ms, repetition rate 560ms.

³⁾ The signal output is secured against short circuits. However, the signal output is not secured against overloading. Constant load currents of > 0.15 A can lead to impermissible heating and subsequent destruction of the ejector.

DISPLAY PARAMETERS

Parameter	Value	Unit	Comment
Display	3	Digit	Red 7-segment LED display
Resolution	± 2	Digit	Unit = mbar
Accuracy	± 3	% FS	$T_{amb} = 25\text{ °C}$, based on FS final value (full-scale)
Linearity error	± 1	%	
Offset error	± 2	Digit	Entered value after zero-point adjustment
Temperature influence	± 3	%	$0\text{ °C} < T_{amb} < 50\text{ °C}$
Display refresh rate	5	1/s	This only affects the red 7-segment display (see the "Electrical parameters" section for signal inputs and outputs).
Idle time before the menu is exited	2	min	The display mode is accessed automatically when no settings are made in a menu.

INTERNAL SWITCHING OF THE POTENTIAL SEPARATION

M12-8, Standard

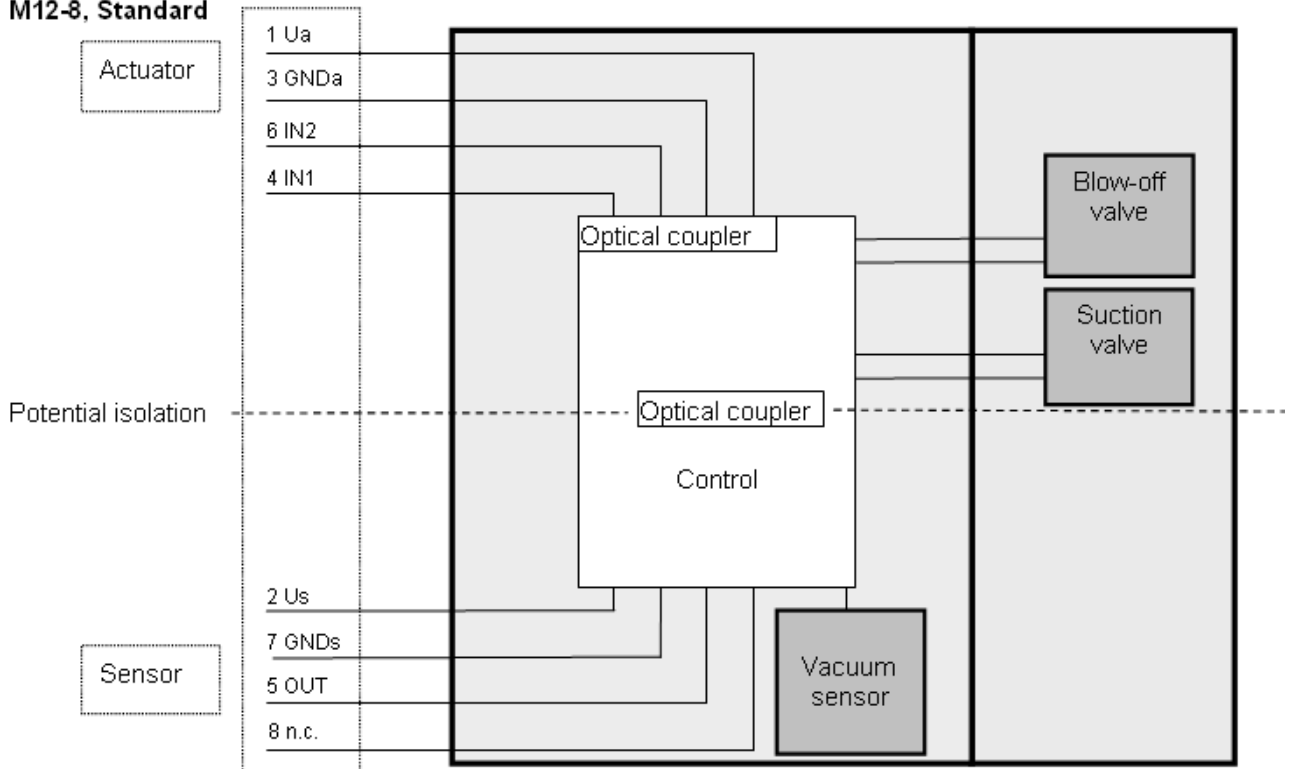

M12-5, Standard

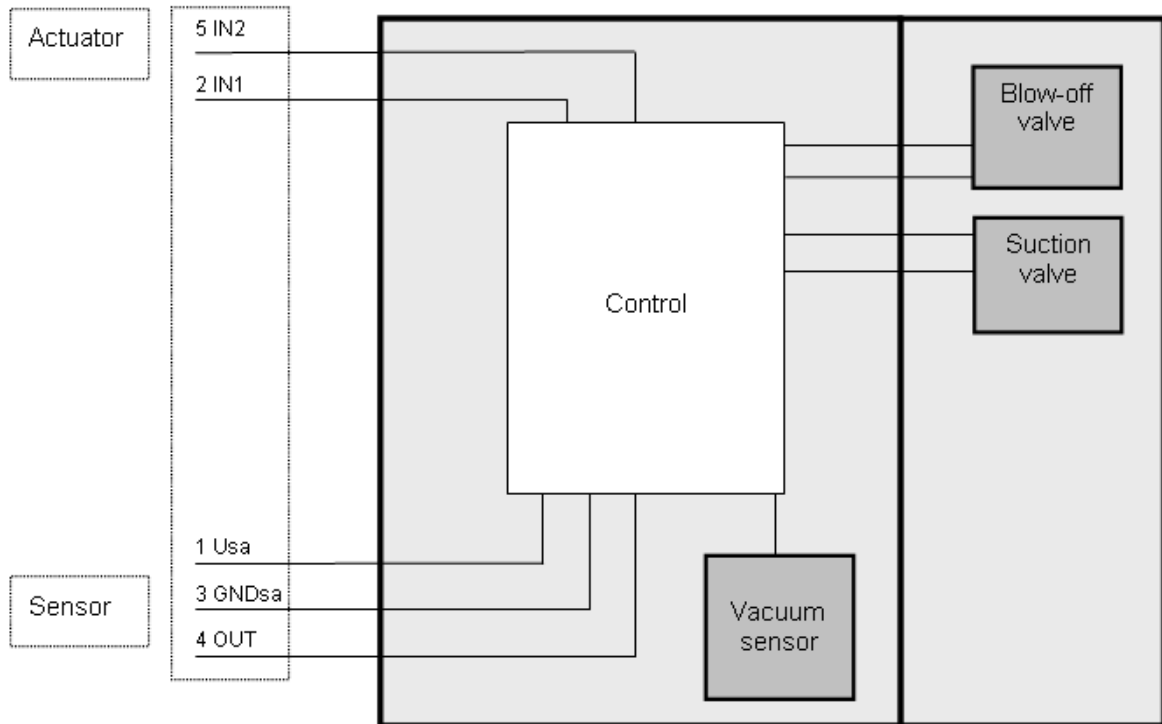

Terms refer to the pin layout of the M12-5 or the M12-8 S connector

Electrical connection

The electrical connection of the ejector is made using a 5-pin or 8-pin M12 male connector. The pin assignment of the connector is as follows:

M12 5-PIN MALE CONNECTOR

Connector	Pin	Core colour ¹⁾	Symbol	Function
	1	Brown	U_{SA}	Power supply
	2	White	IN1	Suction signal input ²⁾
	3	Blue	Gnd_{SA}	Ground
	4	Black	OUT	Parts control signal output
	5	Grey	IN2	Blow-off signal input ³⁾

¹⁾ When Schmalz connection line item no. 21.04.05.00080 is used

²⁾ NO version: Vacuum OFF, NC version: Vacuum ON, IMP version: Vacuum ON only

³⁾ NO/NC version: Blow off ON/OFF, IMP version: Vacuum OFF and blow off ON/OFF

M12 8-PIN MALE CONNECTOR - VERSION WITH POTENTIAL ISOLATION (PT) BETWEEN U_S AND U_A

Connector	Pin	Core colour ¹⁾	Symbol	Function
	1	White	U_A	Power supply for actuator
	2	Brown	U_S	Power supply for sensor
	3	Green	Gnd_A	Actuator ground
	4	Yellow	IN1	Suction signal input ²⁾
	5	Grey	OUT	Parts control signal output
	6	Pink	IN2	Blow-off signal input ³⁾
	7	Blue	Gnd_S	Sensor ground
	8	Red	-	Not connected

¹⁾ When Schmalz connection line item no. 21.04.05.00079 is used

²⁾ NO version: Vacuum OFF, NC version: Vacuum ON, IMP version: Vacuum ON only

³⁾ NO/NC version: Blow off ON/OFF, IMP version: Vacuum OFF and blow off ON/OFF



The ejector may only be operated via power supply units with protected extra-low voltage (PELV). The system must incorporate safe electrical cut-off of the power supply in compliance with EN60204.



The plug connectors may not be connected or disconnected when the system is live.

MECHANICAL DATA

GENERAL PARAMETERS

Parameter	Symbol	Limit values			Unit	Comment
		min.	typ.	max.		
Working temperature of medium and surrounding area	T _{amb}	0	—	50	°C	
Humidity	H _{rel}	10	—	90	% r.h.	Free from condensation
Protection class		—	—	IP65		
Operating pressure	p	4	5	7	bar	
Operating medium	Filtered air or neutral gas, 40 µm, oiled or unoled. Class 5-4-4 compressed air quality according to ISO 8573-1.					

MATERIALS USED

Component	Material
Main body	PA
Inner components	Aluminium alloy, brass, galvanised steel, stainless steel, PU, POM
Controller housing	PA
Silencer cover	PA
Silencer insert	PE
Seals	NBR
Lubrication	Silicone-free

MECHANICAL PERFORMANCE DATA

Type	Nozzle - size	Evacuation level	Suction - capacity ¹⁾	Air consumption (suction) ¹⁾	Air - consumption (blow-off) ¹⁾	Noise - level ¹⁺²⁾	Weight
	mm	%	l/min	l/min	l/min	dBA	kg
SCPi 15	1.5	85	75	115	200	75	0.56
SCPi 20	2.0	85	140	180	200	75	0.56
SCPi 25	2.5	85	195	290	200	78	0.56
SMPi 15	1.5	85	75	115	200	75	0.56
SMPi 20	2.0	85	135	180	200	75	0.56
SMPi 25	2.5	85	185	290	200	78	0.56

¹⁾ At 4.5 bar

²⁾ with vacuum applied

DIMENSIONS

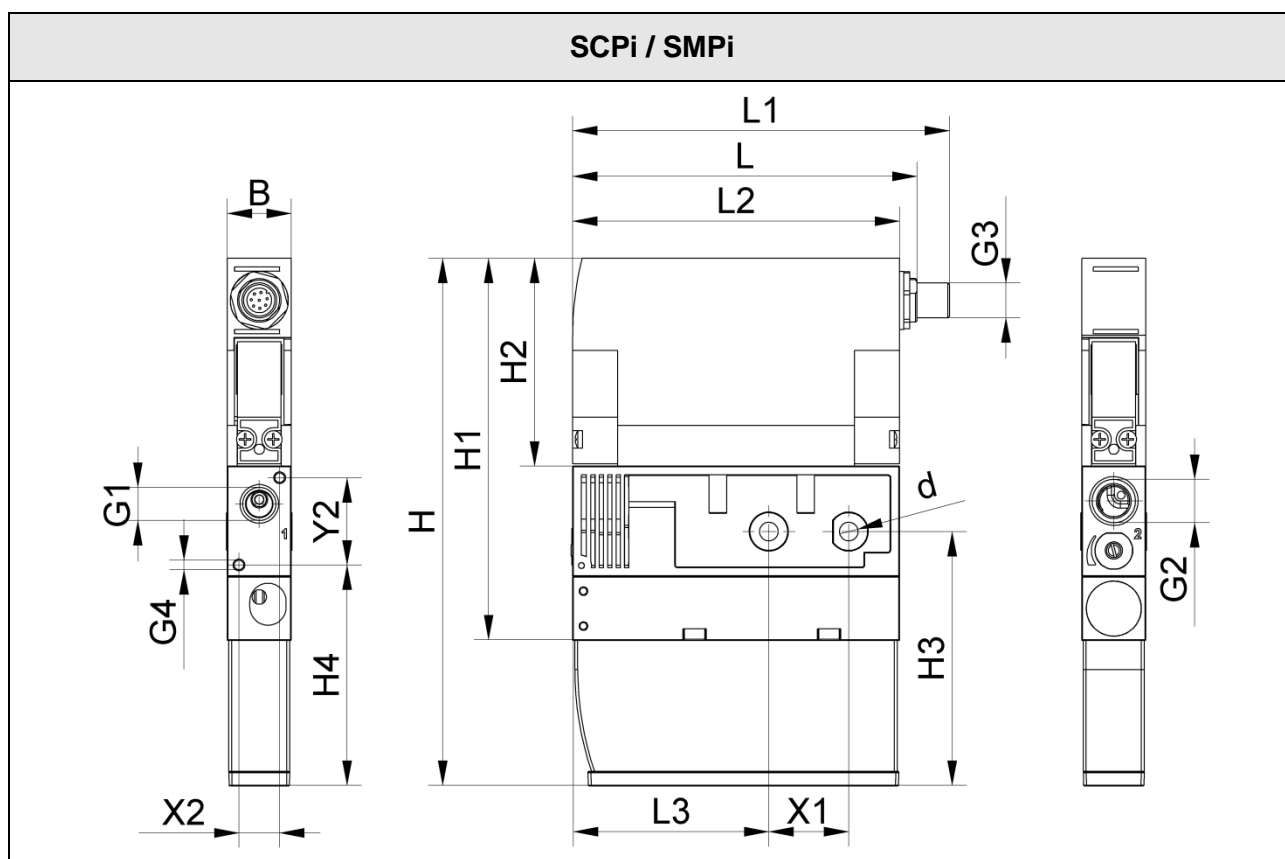

Type	B	d	G1	G2	G3	G4	H	H1	H2
SCPi / SMPi	22,0	6,6	G1/4" internal thread	G3/8" internal thread	M12x1 external thread	M4 internal thread	181.5	131.5	71.5

Type	H3	H4	L	L1	L2	L3	X1	X2	Y2
SCPi / SMPi	87.5	76.0	118.5	129.7	112.5	67.5	27.5	14.0	30.0

All dimensions are in mm.

Maximum torque

Connection	Max. torque
Torque of G1 thread	10 Nm
Torque of G2 thread	10 Nm
Torque of G3 thread	Hand-tight
Torque of G4 thread	5 Nm
Torque of ejector attachment d (a washer must always be used)	6 Nm

CONSTRUCTION DATA OF ACCESSORIES

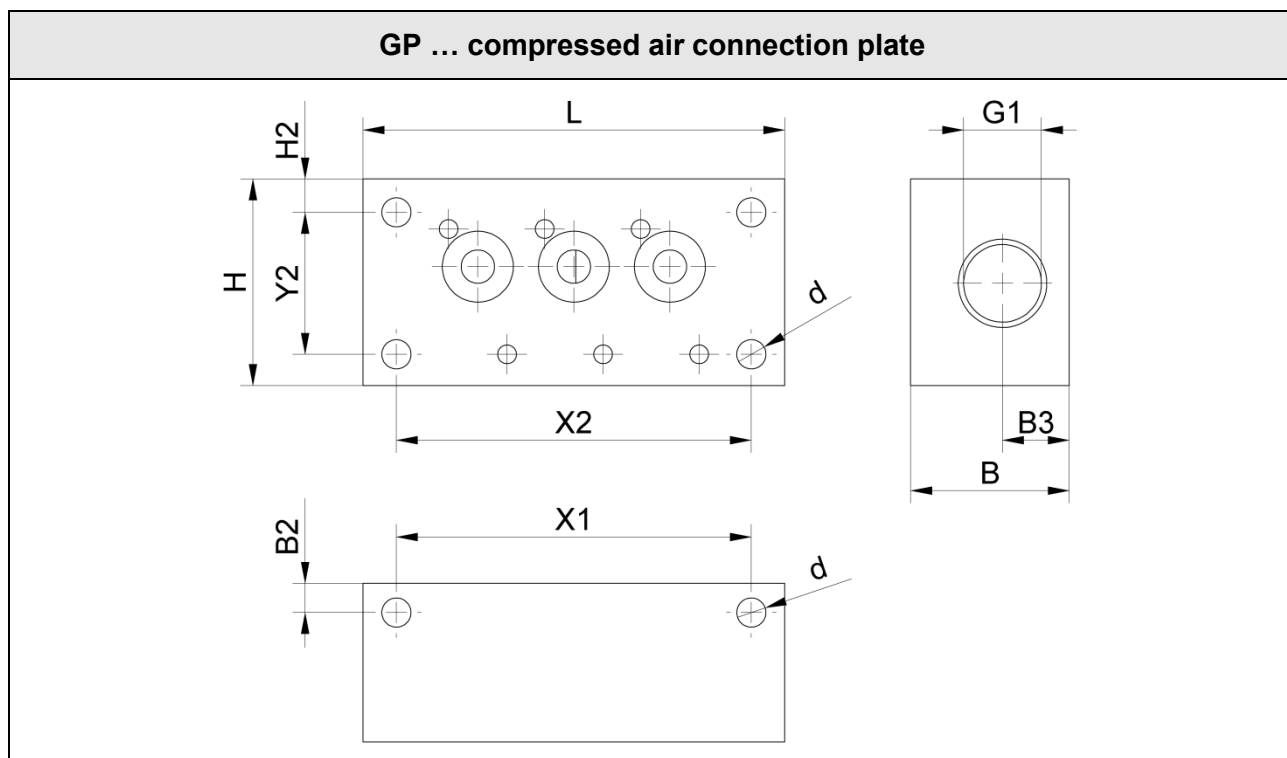

Type	B	B2	B3	d	G1	H	H2	X1	X2	Y2	L	Number of outputs
GP2	38.0	7.0	16.0	7.0	G1/2" internal thread	49.5	8.0	62.0	62.0	34.0	78.0	2
GP3	38.0	7.0	16.0	7.0	G1/2" internal thread	49.5	8.0	85.0	85.0	34.0	101.0	3
GP4	38.0	7.0	16.0	7.0	G1/2" internal thread	49.5	8.0	108.0	108.0	34.0	124.0	4
GP5	38.0	7.0	16.0	7.0	G1/2" internal thread	49.5	8.0	131.0	131.0	34.0	147.0	5
GP6	38.0	7.0	16.0	7.0	G1/2" internal thread	49.5	8.0	154.0	154.0	34.0	170.0	6

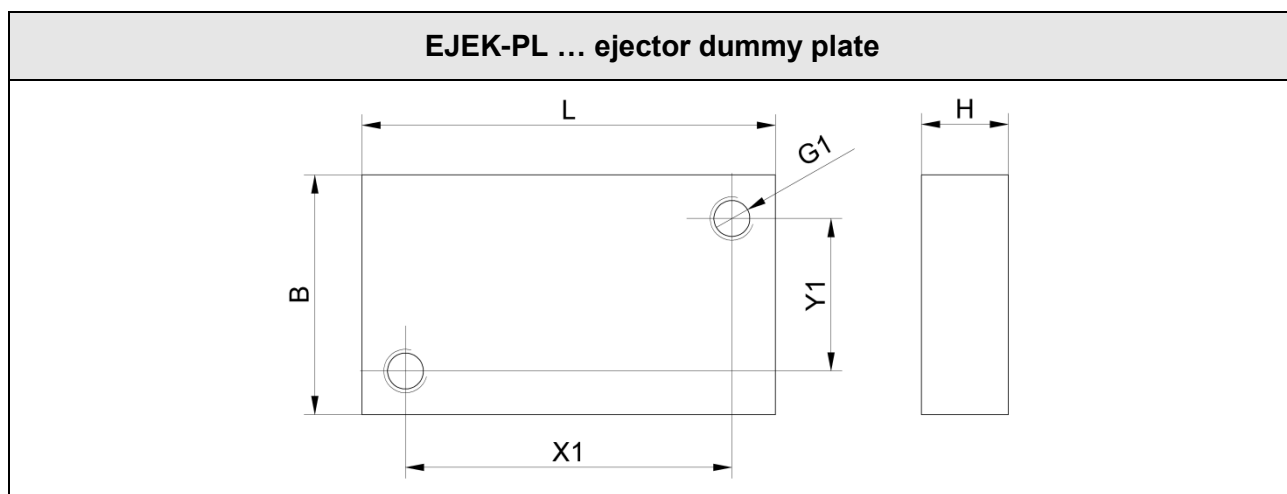

Type	B	G1	H	X1	Y1	L
EJEK-PL	22	M4 internal thread	8.0	30.0	14.0	38.0

All dimensions are in mm.

ADP-Q1 ... quick-change connection

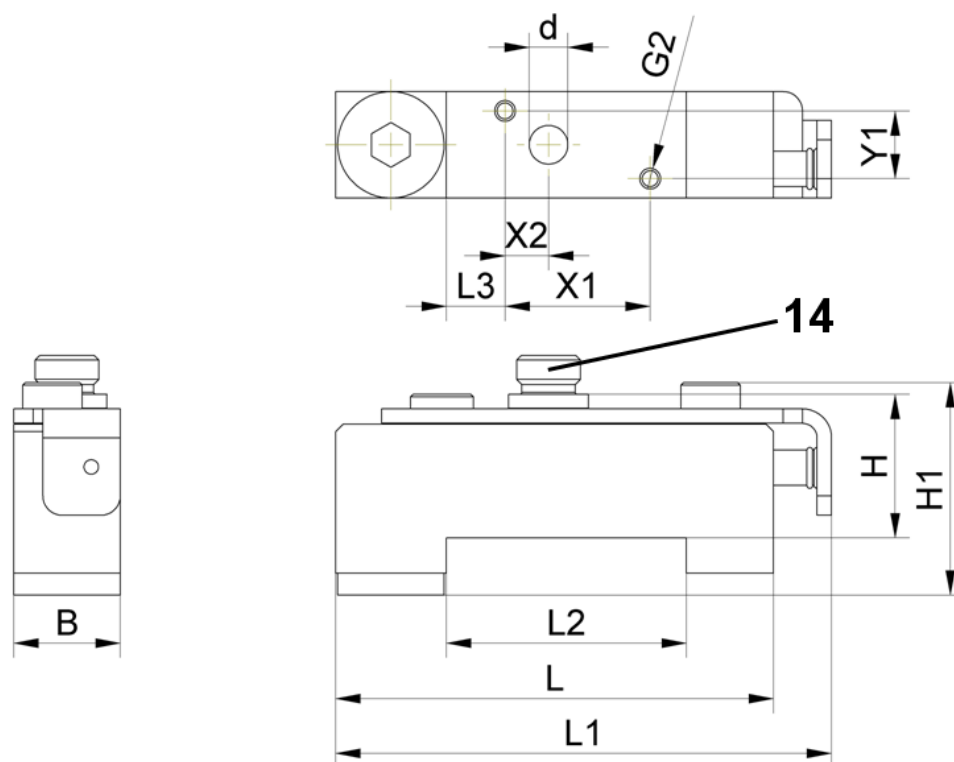

















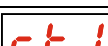





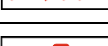

Type	B	d	G2	H	H1	X1	X2	Y1	L	L1	L2	L3	Number of outputs
ADP-Q1	22.0	8.0	M5 internal thread	29.7	43.9	30.0	9.0	14.0	90.5	102.5	49.6	12.1	1

All dimensions are in mm.

ATTACHING THE QUICK-CHANGE CONNECTION

Step	Description
1	Remove the snap bolt (1/4" thread) [14] from the quick-change connection.
2	Screw the snap bolt (1/4" thread) [14] into the G1 compressed air connection on the ejector using medium-strength thread locking compound. Maximum torque = 10 Nm.
3	Observe the minimum drying times of the thread locking compound.
4	Lock the ejector onto the quick-change connection.

OVERVIEW OF DISPLAY SYMBOLS

Symbol	Function	Comment
	H1 switching point	Deactivation value of the air-saving function
	h1 hysteresis	Hysteresis of the air-saving function
	H2 switching point	Activation value for the parts control signal output (when NO output is configured)
	h2 hysteresis	Hysteresis of parts control signal output
	Blow-off time	Setting of the blow-off time for time-controlled blow-off
	Zero-point adjustment (calibration)	Setting of the zero point (calibration)
	Counter 1	Counter for suction cycles (suction signal input)
	Counter 2	Counter for valve switching frequency
	Software version	Displays the current software version
	Serial number	Displays the serial number of the ejector
	Vacuum unit	Vacuum unit in which the measurement and setting values are displayed
	Vacuum (in mbar)	The displayed vacuum is shown in mbar.
	Vacuum (in kPa)	The displayed vacuum is shown in kPa.
	Vacuum (in inHg)	The displayed vacuum is shown in inchHg.
	Configuration of signal type	Menu for configuration of the signal type (NPN / PNP)
	PNP signal type	All input and output signals switch according to PNP (input / output on = 24 V)
	NPN signal type	All input and output signals switch according to NPN (input / output on = 0 V)
	Configuration of signal output	Menu for configuration of the signal output
	Normally open contact	Setting of the signal output as a normally open contact
	Normally closed contact	Setting of the signal output as a normally closed contact
	Air-saving function (control)	Setting of the air-saving function
	Air-saving function on	Activation of the air-saving function
	Air-saving function off	Deactivation of the air-saving function
	Blow-off time	Menu for configuration of the blow-off function

Symbol	Function	Comment
-E-	“External” blow-off	Selection of externally controlled blow-off
J-t	“Internal” blow-off	Selection of internally controlled blow-off (triggered internally; time can be set)
dPY	Display	Selection of the display menu for rotating the display screen
uPS	Display top	Display screen not rotated (standard)
dnS	Display bottom	Display screen rotated by 180°
P in	PIN code	Entry of the PIN code for unlocking the menu
rES	“Clear all” (reset)	All values are reset to the factory settings.
Loc	Menu locked	The keypad and menus remain locked after an incorrect PIN code is entered.
Unc	Menu unlocked	The buttons and menus are unlocked.

FACTORY SETTINGS

Symbol	Function	Factory setting
H-1	H1 switching point	750 mbar
h-1	h1 hysteresis	150 mbar
H-2	H2 switching point	550 mbar
h-2	h2 hysteresis	10 mbar
tBL	Blow-off time	0,20 s
uni	Vacuum unit	-bA Vacuum unit (in mbar)
tYP	Signal type	PnP PNP switch
out	Configuration of output	no Normally open contact
ctr	Air-saving function	Ejector with air-saving function: on Ejector without air-saving function: off
blo	Blow-off function	-E- Externally controlled blow-off
dPY	Display	uPS Display screen not rotated
P in	PIN code	000

8 DECLARATION OF CONFORMITY

DE EG-Konformitätserklärung
 GB EC- Declaration of Conformity
 FR CE-Déclaration de conformité
 ES Certificado de conformidad CE
 IT Dichiarazione di conformità CE
 NL CE Conformiteitsverklaring



Hersteller / Manufacturer / Fabricant / Fabricante / Produttore / Fabrikant

J. Schmalz GmbH, Aacher-Str. 29, D - 72293 Glatten

Produktbezeichnung / Product name / Designation du produit /
 Denominación del producto / Denominazione del prodotto / Beschrijving van de machine

Ejektoren der Serie / Ejectors series / Ejecteurs de la série / Ejectores de la serie / Eiettori de la serie / Ejector Serie SCPi / SMPi

Erfüllte einschlägige EG-Richtlinien / Applicable EC directives met / Directives CE applicables respectées /
 Directivas vigentes de la CE cumplidas / Direttive CE applicate ed osservate / Nagekomen betreffende EG-richtlijnen

- 2006/42/EG Maschinenrichtlinie / Machinery Directive / Directive sur les machines /
 Directiva para máquinas / Direttiva macchine / Machinerichtlijn
- 2004/108/EG Elektromagnetische Verträglichkeit / Electromagnetic Compatibility / Compatibilité électromagnétique /
 Compatibilidad electromagnética / Compatibilità elettromagnetica / Elektromagnetische compatibilität

Angewendete harmonisierte Normen / Harmonised standards applied / Normes d'harmonisation appliquées /
 Normas armonizadas aplicadas / Norme armonizzate adottate / Toegepaste geharmoniseerde normen

- EN ISO 14121-1 Sicherheit von Maschinen - Risikobeurteilung / Safety of machinery – Risk assessment /
 Sécurité des machines - Appréciation du risque / Seguridad de máquinas – Estimación del riesgo /
 Sicurezza delle macchine – Valutazione dei rischi / Veiligheid van machines - Risicobeoordeling
- EN 61000-6-3 Elektromagnetische Verträglichkeit - Störaussendung / Electromagnetic Compatibility - Emission /
 Compatibilité électromagnétique – Norme sur l'émission / Compatibilidad electromagnética – Emisión de interferencias /
 Compatibilità elettromagnetica – Norma generica sull'emissione / Elektromagnetische compatibilität - emissie
- EN 61000-6-2 Elektromagnetische Verträglichkeit - Störfestigkeit / Electromagnetic Compatibility - Immunity /
 Compatibilité électromagnétique – Immunité / Compatibilidad electromagnética – Resistencia a interferencias /
 Compatibilità elettromagnetica – Immunità / Elektromagnetische compatibilität - immunitet

Dokumentationsverantwortlicher / Person responsible for documentation / Responsable de la documentation /
 Responsable de documentación / Responsabile della documentazione / Verantwoordelijk voor de documentatie

Mark Klobas / J. Schmalz GmbH, Aacher-Str. 29, D - 72293 Glatten

Unterschrift, Angaben zum Unterzeichner / Signature, details of signatory / Signature, indications sur le soussigné /
 Firma y datos del firmante / Firma, dati concernenti il firmatario / Handtekening, omschrijving van de ondertekenaar

Glatten, 19.02.2010

Wolfgang Schmalz
 Geschäftsführer / Managing Director / Directeur / Director Gerente / Direttore responsabile / Directeur



Come visit us on the Internet:

Schmalz online – www.schmalz.com

These operating instructions were originally written in German and have been translated into English.

The right to make technical changes is reserved. No responsibility is taken for printing errors or other types of errors.

All information and specifications may be changed without advanced notice.

© J. Schmalz GmbH. All rights reserved.

30.30.01.00078

status: 11.2016 / index 01

Schmalz weltweit – Kompetenz vor Ort mit eigenen Niederlassungen

Schmalz worldwide – local competence with own subsidiaries

Brazil

Tel.+55 4130720738
Fax+55 4130720739
schmalz@schmalz.com.br

Canada

Tel.+1 905 569 9520
Fax+1 905 569 8256
schmalz@schmalz.ca

China

Tel.+86 21 5109 9933
Fax+86 21 5039 8882
schmalz@schmalz.net.cn

Finland

Tel.+358 9 85746 92
Fax+358 9 85746 94
schmalz@schmalz.fi

France

Tel.+33 (0) 1 6473 1730
Fax+33 (0) 1 6006 6371
schmalz@schmalz.fr

India

Tel.+91 (0) 20 4072 5500
Fax+91 (0) 20 4072 5588
schmalz@schmalz.co.in

Italy

Tel.+39 0321 621510
Fax+39 0321 621714
schmalz@schmalz.it

Japan

Tel.+81 45 308 9940
Fax+81 45 308 9941
schmalz@schmalz.co.jp

Netherlands

Tel.+31 (0)74 255 5757
Fax+31 (0)74 255 5758
schmalz@schmalz.nl

Poland

Tel.+48 (0)22 46 04970
Fax+48 (0)22 87 40062
schmalz@schmalz.pl

Russia

Tel.+7 495 9671 248
Fax+7 495 9671 249
schmalz@schmalz.ru

Spain

Tel.+34 94 4805585
Fax+34 94 4807264
schmalz@schmalz.es

South Korea

Tel.+82 31 8162403
Fax+82 31 8162404
schmalz@schmalz.co.kr

Switzerland

Tel.+41 44 88875 25
Fax+41 44 88875 29
schmalz@schmalz.ch

Turkey

Tel.+90 216 3400121
Fax+90 216 3400124
schmalz@schmalz.com.tr

USA

Tel.+1 919 7130880
Fax+1 919 7130883
schmalz@schmalz.us

J. Schmalz GmbH

Aacher Strasse 29
D-72293 Glatten
Tel. +49 (0)7443 2403 0
Fax +49 (0)7443 2403 259
schmalz@schmalz.de
www.schmalz.com