

Vacuum hose

VSL 44-38 PU-DS

Part no.: 10.07.09.00031

<https://www.schmalz.com/10.07.09.00031>



Homepage > Vacuum Technology for Automation > Vacuum Components > Filters and Connections > Hoses and Connectors > Vacuum /
Compressed-Air Hoses VSL > VSL 44-38 PU-DS

Hose for vacuum and compressed-air systems



External diameter D: 44 mm
Internal diameter d: 38 mm
Length (max): 10 m
Material: PU, with wire spiral
Installation radius (min): 95 mm
Pressure range (operating pressure):
-0.82 ... 3.12 bar
Ambient temperature: -20 ... 90 °C

Design Data

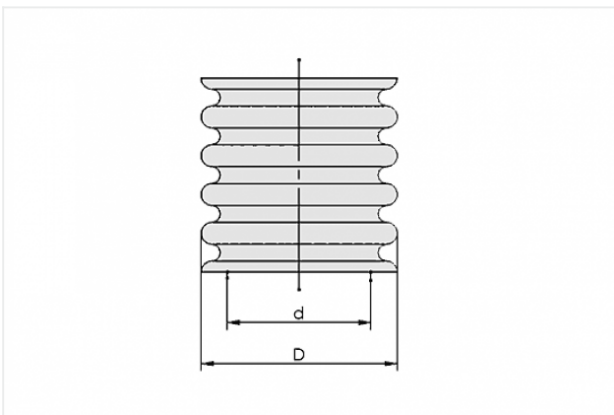

Attribute	Value
d	38 mm
D	44 mm

Technical Data

Attribute	Value
Material	PU, with wire spiral
Pressure range (operating pressure)	-0.82 ... 3.12 bar

Contact to Schmalz

J. Schmalz GmbH | Johannes-Schmalz-Straße, 72293 Glatten, Deutschland | +49 7443 2403-102 |
customercenter@schmalz.de

Attribute	Value
Ambient temperature	-20 ... 90 °C
Installation radius (min)	95 mm
Length (max)	10 m
Weight/Meter	460 g/m
Weight/Meter	0.46 kg/m

Note:

- Operating pressure: In reference to media and ambient temperature of + 20°C
- Bending radius: Referred to the inner side of the hose bend in a static state
- Max. length: Please indicate the tube length when placing the order!

Accessories



SSD 43-49 ST-VZ

Part no. 10.07.10.00020

Hose clamp for securing wire-reinforced hoses

Clamping range: 43.0 ... 49.0 mm

Material: Steel

Surface: galvanised



ST G1-1/2-AG 38 MS-V

Part no. 10.08.03.00170

Hose sleeve

Thread 1: G1-1/2-M

Internal hose diameter: 38 mm

Material: Brass

Surface: nickel plated

