

Universal holder

HTR-UNI 2N G2 200

<https://www.schmalz.com/10.01.03.00309>



Part no.: 10.01.03.00309

Homepage > Vacuum Technology for Automation > Vacuum Components > Mounting Elements > Holder for Suction Cups and Spring Plungers > Universal Holders HTR-UNI > HTR-UNI 2N G2 200

Universal holder for adjustable mounting of suction cups



Cross-beam connection:
2 Sliding blocks
Suction cup connection: G1/4"-M
Overall length: 200 mm
Ambient temperature: 0 ... 80 °C

Design Data

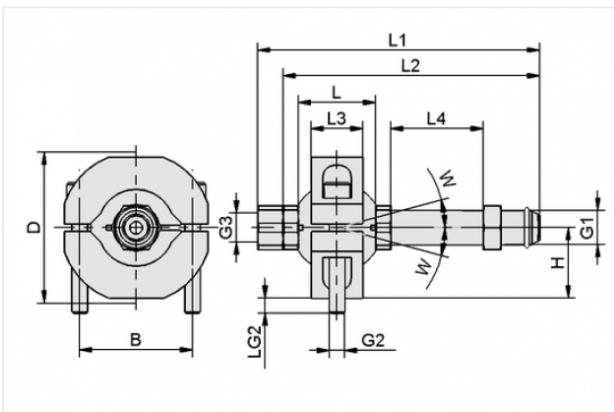

Attribute	Value
B	44 mm
D	59 mm
G1	G1/4"-M
G2	M6-M
G3	G1/4"-F
H	27.5 mm
L	30 mm
L1	200 mm
L2	190 mm
L3	20 mm
L4	126 mm
LG2	6 mm
W	15 °

Contact to Schmalz

J. Schmalz GmbH | Johannes-Schmalz-Straße, 72293 Glatten, Deutschland | +49 7443 2403-102 | customercenter@schmalz.de

Technical Data

Attribute	Value
Weight	222.1 g

Spare Parts



SAUG-ANB G1/4-AG 200

Part no. 10.01.03.00308

Suction cup connection (rigid)

Suction cup connection: G1/4-M

Length L: 200 mm