

Spring plunger

FSTA-HD G1/2-AG 50 VG

<https://www.schmalz.com/10.01.02.00890>



Part no.: 10.01.02.00890

Homepage > Vacuum Technology for Automation > Vacuum Components > Mounting Elements > Spring plungers > Spring Plungers FSTA-HD > FSTA-HD G1/2-AG 50 VG

Spring plunger with both-way damping and height compensation, heavy-duty



Suction cup connection: G1/2-M
 Vacuum connection: G3/8-F
 Spring stroke Z: 50 mm
 Shape: With rotation lock

Design Data

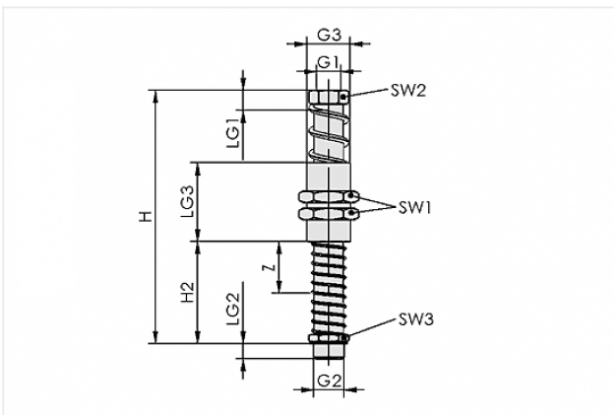

Attribute	Value
G1	G3/8"-F
G2	G1/2"-M
G3	M30x1.5-M
H	176.5 mm
H2	70.3 mm
LG1	12 mm
LG2	10.5 mm
LG3	53 mm
SW1	36 mm
SW2	24 mm
SW3	24 mm
Z	50 mm

Contact to Schmalz

J. Schmalz GmbH | Johannes-Schmalz-Straße, 72293 Glatten, Deutschland | +49 7443 2403-102 | customercenter@schmalz.de

Technical Data

Attribute	Value
Shape	With rotation lock
Spring rate	1.81 N/mm
Spring pretension	3.95 N
Spring force, centre	49.2 N
Vertical load	4900 N
Horizontal load	1200 N
Weight	540 g
Ambient temperature	0 ... 80 °C

Note:

- Spring force: Referred to 50% of operating stroke
- Static loading: Maximum static loading
- Horizontal stress: The specification of the horizontal stress refers to the lower edge of the plunger with extended spring. It is a maximum static stress and it impairs the spring compression and extension in horizontal position

Accessories



FLK G1/2-IG G1/2-AG

Part no. 10.01.03.00175

Flexible suction cup mounting for adaptation to sloping surfaces

Thread G1: G1/2-F

Thread G2: G1/2-M

Ambient temperature: 0 ... 70 °C



FLK G1/2-IG G1/2-AG V

Part no. 10.01.03.00207

Flexible suction cup mounting for adaptation to sloping surfaces

Thread G1: G1/2-F

Thread G2: G1/2-M

Shape: Reinforced

Ambient temperature: 0 ... 70 °C



KGL G1/2-IG G1/2-AG

Part no. 10.01.03.00111

Suction cup mounting with joint for adaptation to sloping surfaces

Thread 1: G1/2-F

Thread 2: G1/2-M

Height: 40 mm



HTR-STA 62 1N D30 WI

Part no. 10.08.03.00148

Holder for flexible mounting of suction cups/spring plungers on sections

Length L: 62 mm

Cross-beam connection: Sliding block

Suction cup or spring plunger conn.:

Contour D30-G1/2

Shape: angled



HTR-STS 40x40 D30 WI

Part no. 10.08.03.00090

Holder for flexible mounting of suction cups/spring plungers on square tubes

Cross-beam connection: 40x40

Suction cup or spring plunger conn.:

Contour D30-G1/2

Shape: angled



HTR-STS 50x50 D30 WI

Part no. 10.08.03.00091

Holder for flexible mounting of suction cups/spring plungers on square tubes

Cross-beam connection: 50x50

Suction cup or spring plunger conn.:

Contour D30-G1/2

Shape: angled



HTR-STS 60x60 D30 WI

Part no. 10.08.03.00092

Holder for flexible mounting of suction cups/spring plungers on square tubes

Cross-beam connection: 60x60

Suction cup or spring plunger conn.:

Contour D30-G1/2

Shape: angled



ST G3/8-AG 9 MS-V

Part no. 10.08.03.00159

Hose sleeve

Thread 1: G3/8-M

Internal hose diameter: 9 mm

Material: Brass

Surface: nickel plated



ST G3/8-AG 12 MS-V

Part no. 10.08.03.00160

Hose sleeve

Thread 1: G3/8-M

Internal hose diameter: 12 mm

Material: Brass

Surface: nickel plated



STV-GE G3/8-AG 8

Part no. 10.08.02.00237

Screw plug connection, straight

Thread G1: G3/8-M

External hose diameter: 8 mm

Material: Brass

Surface: nickel plated

Ambient temperature: -20 ... 80 °C



STV-GE G3/8-AG 10

Part no. 10.08.02.00252

Screw plug connection, straight

Thread G1: G3/8-M

External hose diameter: 10 mm

Material: Brass

Surface: nickel plated

Ambient temperature: -20 ... 80 °C



STV-GE G3/8-AG 12

Part no. 10.08.02.00209

Screw plug connection, straight

Thread G1: G3/8-M

External hose diameter: 12 mm

Material: Brass

Surface: nickel plated

Ambient temperature: -20 ... 80 °C



STV-GE G3/8-AG 14

Part no. 10.08.02.00211

Screw plug connection, straight

Thread G1: G3/8-M

External hose diameter: 14 mm

Material: Brass

Surface: nickel plated

Ambient temperature: -20 ... 80 °C



STV-W G3/8-AG 8

Part no. 10.08.02.00236

Screw plug connection, swivelling elbow

Thread G1: G3/8-M

External hose diameter: 8 mm

Material: Brass, nickel-plated

Ambient temperature: -20 ... 80 °C



STV-W G3/8-AG 10

Part no. 10.08.02.00255

Screw plug connection, swivelling elbow

Thread G1: G3/8-M

External hose diameter: 10 mm

Material: Brass, nickel-plated

Ambient temperature: -20 ... 80 °C



STV-W G3/8-AG 12

Part no. 10.08.02.00163

Screw plug connection, swivelling elbow

Thread G1: G3/8-M

External hose diameter: 12 mm

Material: Brass, nickel-plated

Ambient temperature: -20 ... 80 °C



STV-WF G3/8-AG 8

Part no. 10.08.02.00234

Screw plug connection, swivelling and lockable

Thread G1: G3/8-M

External hose diameter: 8 mm

Material: Brass, nickel-plated



STV-WF G3/8-AG 10

Part no. 10.08.02.00259

Screw plug connection, swivelling and lockable

Thread G1: G3/8-M

External hose diameter: 10 mm

Material: Brass, nickel-plated