

Spring plunger

FSTE-HD G1/4-AG 75 VG

<https://www.schmalz.com/10.01.02.00877>



Part no.: 10.01.02.00877

Homepage > Vacuum Technology for Automation > Vacuum Components > Mounting Elements > Spring plungers > Spring Plungers FSTE-HD > FSTE-HD G1/4-AG 75 VG

Spring plunger with damping and height compensation, heavy-duty



Suction cup connection: G1/4-M
 Vacuum connection: G1/8-F
 Spring stroke Z: 75 mm
 Shape: With rotation lock

Design Data

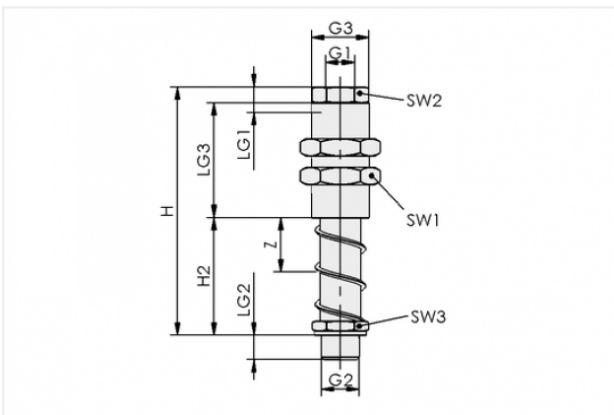

Attribute	Value
G1	G1/8"-F
G2	G1/4"-M
G3	M20x1.5-M
H	145 mm
H2	99.5 mm
LG1	12.8 mm
LG2	8.5 mm
LG3	40 mm
SW1	24 mm
SW2	17 mm
SW3	17 mm
Z	75 mm

Contact to Schmalz

J. Schmalz GmbH | Johannes-Schmalz-Straße, 72293 Glatten, Deutschland | +49 7443 2403-102 | customercenter@schmalz.de

Technical Data

Attribute	Value
Shape	With rotation lock
Spring rate	0.262 N/mm
Spring pretension	5.38 N
Spring force, centre	15.2 N
Vertical load	2400 N
Horizontal load	340 N
Weight	190 g
Ambient temperature	0 ... 80 °C

Note:

- Spring force: Referred to 50% of operating stroke
- Static loading: Maximum static loading
- Horizontal stress: The specification of the horizontal stress refers to the lower edge of the plunger with extended spring. It is a maximum static stress and it impairs the spring compression and extension in horizontal position

Accessories



FLK G1/4-IG G1/4-AG

Part no. 10.01.03.00178

Flexible suction cup mounting for adaptation to sloping surfaces

Thread G1: G1/4-F

Thread G2: G1/4-M

Ambient temperature: 0 ... 70 °C



KGL G1/4-IG G1/4-AG

Part no. 10.01.03.00110

Suction cup mounting with joint for adaptation to sloping surfaces

Thread 1: G1/4-F

Thread 2: G1/4-M

Height: 37.5 mm



KGL G1/4-IG M10x1.25-AG

Part no. 10.01.03.00137

Suction cup mounting with joint for adaptation to sloping surfaces

Thread 1: G1/4-F

Thread 2: M10x1.25-M

Height: 37.5 mm



FLK G1/4-IG M10x1.25-AG

Part no. 10.01.03.00206

Flexible suction cup mounting for adaptation to sloping surfaces

Thread G1: G1/4-F

Thread G2: M10x1.25-M

Ambient temperature: 0 ... 70 °C

**HTR-STA 55 1N D20 WI**

Part no. 10.08.03.00086

Holder for flexible mounting of suction cups/spring plungers on sections

Length L: 55 mm

Cross-beam connection: Sliding block

Suction cup or spring plunger conn.:

Contour D20-G1/4

Shape: angled

**HTR-UNI 2N FSTE-HDB**

Part no. 10.01.03.00332

Universal holder for adjustable mounting of suction cups

Cross-beam connection:

2 Sliding blocks

Shape: for FSTE-HDB

**ST G1/8-AG 4 MS-V**

Part no. 10.08.03.00153

Hose sleeve

Thread 1: G1/8-M

Internal hose diameter: 4 mm

Material: Brass

Surface: nickel plated



ST G1/8-AG 6 MS-V

Part no. 10.08.03.00154

Hose sleeve

Thread 1: G1/8-M

Internal hose diameter: 6 mm

Material: Brass

Surface: nickel plated



ST G1/8-AG 9 MS-V

Part no. 10.08.03.00155

Hose sleeve

Thread 1: G1/8-M

Internal hose diameter: 9 mm

Material: Brass

Surface: nickel plated



STV-GE G1/8-AG 4

Part no. 10.08.02.00202

Screw plug connection, straight

Thread G1: G1/8-M

External hose diameter: 4 mm

Material: Brass

Surface: nickel plated

Ambient temperature: -20 ... 80 °C



STV-GE G1/8-AG 6

Part no. 10.08.02.00204

Screw plug connection, straight

Thread G1: G1/8-M

External hose diameter: 6 mm

Material: Brass

Surface: nickel plated

Ambient temperature: -20 ... 80 °C



STV-GE G1/8-AG 8

Part no. 10.08.02.00206

Screw plug connection, straight

Thread G1: G1/8-M

External hose diameter: 8 mm

Material: Brass

Surface: nickel plated



STV-W G1/8-AG 4

Part no. 10.08.02.00156

Screw plug connection, swivelling elbow

Thread G1: G1/8-M

External hose diameter: 4 mm

Material: Brass, nickel-plated

Ambient temperature: -20 ... 80 °C



STV-W G1/8-AG 6

Part no. 10.08.02.00158

Screw plug connection, swivelling elbow

Thread G1: G1/8-M

External hose diameter: 6 mm

Material: Brass, nickel-plated

Ambient temperature: -20 ... 80 °C



STV-W G1/8-AG 8

Part no. 10.08.02.00160

Screw plug connection, swivelling elbow

Thread G1: G1/8-M

External hose diameter: 8 mm

Material: Brass, nickel-plated

Ambient temperature: -20 ... 80 °C



STV-GE G1/8-AG 6 HT

Part no. 10.08.02.00389

Screw plug connection, straight

Thread G1: G1/8-M

External hose diameter: 6 mm

Material: Brass

Surface: nickel plated

Ambient temperature: -50 ... 200 °C

Type: HT



STV-W G1/8-AG 6

Part no. 10.08.02.00288

Screw plug connection, swivelling elbow

Thread G1: G1/8-M

External hose diameter: 6 mm

Material: Plastic



STV-W G1/8-AG 6 HT

Part no. 10.08.02.00391

Screw plug connection, swivelling elbow

Thread G1: G1/8-M

External hose diameter: 6 mm

Material: Brass

Surface: nickel plated

Ambient temperature: -50 ... 200 °C

Type: HT



STV-WF G1/8-AG 4

Part no. 10.08.02.00166

Screw plug connection, swivelling and lockable

Thread G1: G1/8-M

External hose diameter: 4 mm

Material: Brass, nickel-plated



STV-WF G1/8-AG 6

Part no. 10.08.02.00168

Screw plug connection, swivelling and lockable

Thread G1: G1/8-M

External hose diameter: 6 mm

Material: Brass, nickel-plated



STV-WF G1/8-AG 8

Part no. 10.08.02.00170

Screw plug connection, swivelling and lockable

Thread G1: G1/8-M

External hose diameter: 8 mm

Material: Brass, nickel-plated



STV-WF G1/8-AG 10

Part no. 10.08.02.00257

Screw plug connection, swivelling and lockable

Thread G1: G1/8-M

External hose diameter: 10 mm

Material: Brass, nickel-plated



STV-T G1/8-AG 4

Part no. 10.09.02.00039

Screw plug connection, T

Thread 1: G1/8-M

External hose diameter: 4 mm

Length: 32.5 mm

Material: Brass

Surface: nickel plated



STV-T G1/8-AG 6

Part no. 10.09.02.00040

Screw plug connection, T

Thread 1: G1/8-M

External hose diameter: 6 mm

Length: 41.5 mm

Material: Brass

Surface: nickel plated



STV-T G1/8-AG 8

Part no. 10.09.02.00041

Screw plug connection, T

Thread 1: G1/8-M

External hose diameter: 8 mm

Length: 48.7 mm

Material: Brass

Surface: nickel plated