

Spring plunger FSTE-HD G1/8-AG 25

<https://www.schmalz.com/10.01.02.00757>



Part no.: 10.01.02.00757

Homepage > Vacuum Technology for Automation > Vacuum Components > Mounting Elements > Spring plungers > Spring Plungers FSTE-HD > FSTE-HD G1/8-AG 25

Spring plunger with damping and height compensation, heavy-duty



Suction cup connection: G1/8-M
Vacuum connection: G1/8-F
Spring stroke Z: 25 mm

Design Data

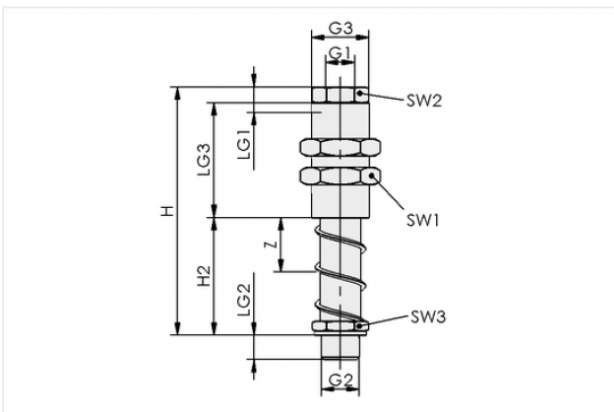

Attribute	Value
G1	G1/8"-F
G2	G1/8"-M
G3	M16x1-M
H	85.5 mm
H2	41.5 mm
LG1	8 mm
LG2	7.5 mm
LG3	30 mm
SW1	22 mm
SW2	12 mm
SW3	14 mm
Z	25 mm

Contact to Schmalz

J. Schmalz GmbH | Johannes-Schmalz-Straße, 72293 Glatten, Deutschland | +49 7443 2403-102 | customercenter@schmalz.de

Technical Data

Attribute	Value
Spring rate	0.143 N/mm
Spring pretension	3.57 N
Spring force, centre	5.36 N
Vertical load	3700 N
Horizontal load	283 N
Weight	90 g
Ambient temperature	0 ... 80 °C

Note:

- Spring force: Referred to 50% of operating stroke
- Static loading: Maximum static loading
- Horizontal stress: The specification of the horizontal stress refers to the lower edge of the plunger with extended spring. It is a maximum static stress and it impairs the spring compression and extension in horizontal position

Accessories



KGL G1/8-IG G1/8-AG A2

Part no. 10.01.03.00109

Suction cup mounting with joint for adaptation to sloping surfaces

Thread 1: G1/8-F

Thread 2: G1/8-M

Height: 26.5 mm

Material: Stainless steel



HTR-STA 47 1N D10/16 FL

Part no. 10.08.03.00085

Holder for flexible mounting of suction cups/spring plungers on sections

Length L: 47 mm

Cross-beam connection: Sliding block

Suction cup or spring plunger conn.:

Contour D10 and D16

Shape: flat



HTR-STS 30x30 D10/16 WI

Part no. 10.08.03.00088

Holder for flexible mounting of suction cups/spring plungers on square tubes

Cross-beam connection: 30x30

Suction cup or spring plunger conn.:

Contour D10 and D16

Shape: angled



HTR-STS 40x40 D10/16 WI

Part no. 10.08.03.00089

Holder for flexible mounting of suction cups/spring plungers on square tubes

Cross-beam connection: 40x40

Suction cup or spring plunger conn.:

Contour D10 and D16

Shape: angled

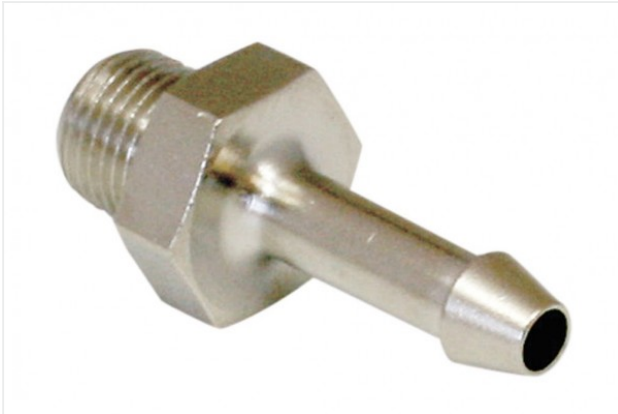

ST G1/8-AG 4 MS-V

Part no. 10.08.03.00153

Hose sleeve

Thread 1: G1/8-M

Internal hose diameter: 4 mm

Material: Brass

Surface: nickel plated



ST G1/8-AG 6 MS-V

Part no. 10.08.03.00154

Hose sleeve

Thread 1: G1/8-M

Internal hose diameter: 6 mm

Material: Brass

Surface: nickel plated



ST G1/8-AG 9 MS-V

Part no. 10.08.03.00155

Hose sleeve

Thread 1: G1/8-M

Internal hose diameter: 9 mm

Material: Brass

Surface: nickel plated



STV-GE G1/8-AG 4

Part no. 10.08.02.00202

Screw plug connection, straight

Thread G1: G1/8-M

External hose diameter: 4 mm

Material: Brass

Surface: nickel plated

Ambient temperature: -20 ... 80 °C



STV-GE G1/8-AG 6

Part no. 10.08.02.00204

Screw plug connection, straight

Thread G1: G1/8-M

External hose diameter: 6 mm

Material: Brass

Surface: nickel plated

Ambient temperature: -20 ... 80 °C



STV-GE G1/8-AG 8

Part no. 10.08.02.00206

Screw plug connection, straight

Thread G1: G1/8-M

External hose diameter: 8 mm

Material: Brass

Surface: nickel plated



STV-W G1/8-AG 4

Part no. 10.08.02.00156

Screw plug connection, swivelling elbow

Thread G1: G1/8-M

External hose diameter: 4 mm

Material: Brass, nickel-plated

Ambient temperature: -20 ... 80 °C



STV-W G1/8-AG 6

Part no. 10.08.02.00158

Screw plug connection, swivelling elbow

Thread G1: G1/8-M

External hose diameter: 6 mm

Material: Brass, nickel-plated

Ambient temperature: -20 ... 80 °C



STV-W G1/8-AG 8

Part no. 10.08.02.00160

Screw plug connection, swivelling elbow

Thread G1: G1/8-M

External hose diameter: 8 mm

Material: Brass, nickel-plated

Ambient temperature: -20 ... 80 °C



STV-GE G1/8-AG 6 HT

Part no. 10.08.02.00389

Screw plug connection, straight

Thread G1: G1/8-M

External hose diameter: 6 mm

Material: Brass

Surface: nickel plated

Ambient temperature: -50 ... 200 °C

Type: HT



STV-W G1/8-AG 6

Part no. 10.08.02.00288

Screw plug connection, swivelling elbow

Thread G1: G1/8-M

External hose diameter: 6 mm

Material: Plastic



STV-W G1/8-AG 6 HT

Part no. 10.08.02.00391

Screw plug connection, swivelling elbow

Thread G1: G1/8-M

External hose diameter: 6 mm

Material: Brass

Surface: nickel plated

Ambient temperature: -50 ... 200 °C

Type: HT



STV-WF G1/8-AG 4

Part no. 10.08.02.00166

Screw plug connection, swivelling and lockable

Thread G1: G1/8-M

External hose diameter: 4 mm

Material: Brass, nickel-plated



STV-WF G1/8-AG 6

Part no. 10.08.02.00168

Screw plug connection, swivelling and lockable

Thread G1: G1/8-M

External hose diameter: 6 mm

Material: Brass, nickel-plated



STV-WF G1/8-AG 8

Part no. 10.08.02.00170

Screw plug connection, swivelling and lockable

Thread G1: G1/8-M

External hose diameter: 8 mm

Material: Brass, nickel-plated



STV-WF G1/8-AG 10

Part no. 10.08.02.00257

Screw plug connection, swivelling and lockable

Thread G1: G1/8-M

External hose diameter: 10 mm

Material: Brass, nickel-plated



STV-T G1/8-AG 4

Part no. 10.09.02.00039

Screw plug connection, T

Thread 1: G1/8-M

External hose diameter: 4 mm

Length: 32.5 mm

Material: Brass

Surface: nickel plated



STV-T G1/8-AG 6

Part no. 10.09.02.00040

Screw plug connection, T

Thread 1: G1/8-M

External hose diameter: 6 mm

Length: 41.5 mm

Material: Brass

Surface: nickel plated



STV-T G1/8-AG 8

Part no. 10.09.02.00041

Screw plug connection, T

Thread 1: G1/8-M

External hose diameter: 8 mm

Length: 48.7 mm

Material: Brass

Surface: nickel plated