

Cross-beam connection

<https://www.schmalz.com/10.08.03.00092>



HTR-STS 60x60 D30 WI

Part no.: 10.08.03.00092

Homepage > Vacuum Technology for Automation > Vacuum Components > Mounting Elements > Holder for Suction Cups and Spring Plungers >

Holder for Square Tubes HTR-STS > HTR-STS 60x60 D30 WI

Holder for flexible mounting of suction cups/spring plungers on square tubes



Cross-beam connection: 60x60
Suction cup or spring plunger conn.:
Contour D30-G1/2
Shape: angled

Design Data

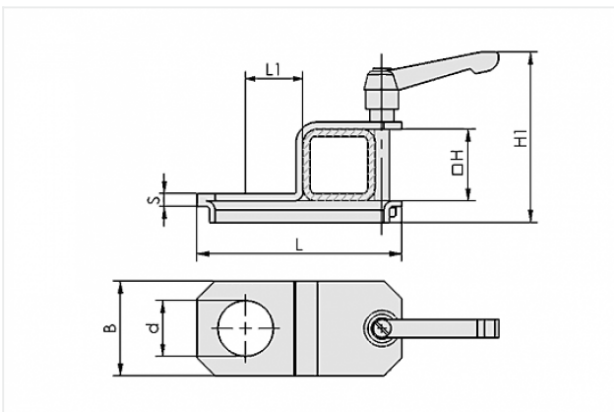

Attribute	Value
-----------	-------

B	53 mm
---	-------

d	31 mm
---	-------

H	60 mm
---	-------

H1	115 mm
----	--------

L	134 mm
---	--------

L1	32 mm
----	-------

s	7 mm
---	------

Technical Data

Attribute	Value
-----------	-------

Weight	533 g
--------	-------

Contact to Schmalz

J. Schmalz GmbH | Johannes-Schmalz-Straße, 72293 Glatten, Deutschland | +49 7443 2403-102 | customercenter@schmalz.de

Accessories



SCHE 35-16.5x5 ST VZ

Part no. 10.01.01.10025

Washer with shoulder

External diameter D: 35 mm

Internal diameter d: 16.5 mm

Length L1: 5 mm

Material: Steel

Surface: galvanised



SCHE 38-18.5x5 ST VZ

Part no. 10.01.03.06140

Washer with shoulder

External diameter D: 38 mm

Internal diameter d: 18.5 mm

Length L1: 5 mm

Material: Steel

Surface: galvanised



SCHE 38-21.5x5 ST VZ

Part no. 10.01.01.10015

Washer with shoulder

External diameter D: 38 mm

Internal diameter d: 21.5 mm

Length L1: 5 mm

Material: Steel

Surface: galvanised



SCHE 7090 M30 ST VZ

Part no. 20.06.01.00044

Washer (Standard)

Standard: ISO 7090

for: M30

Material: Steel

Surface: galvanised