

# Cross-beam connection

<https://www.schmalz.com/10.08.03.00148>



## HTR-STA 62 1N D30 WI

Part no.: 10.08.03.00148

Homepage > Vacuum Technology for Automation > Vacuum Components > Mounting Elements > Holder for Suction Cups and Spring Plungers >

Holders for Light-Metal Sections HTR-STA > HTR-STA 62 1N D30 WI

### Holder for flexible mounting of suction cups/spring plungers on sections



Length L: 62 mm

Cross-beam connection: Sliding block

Suction cup or spring plunger conn.:

Contour D30-G1/2

Shape: angled

### Design Data

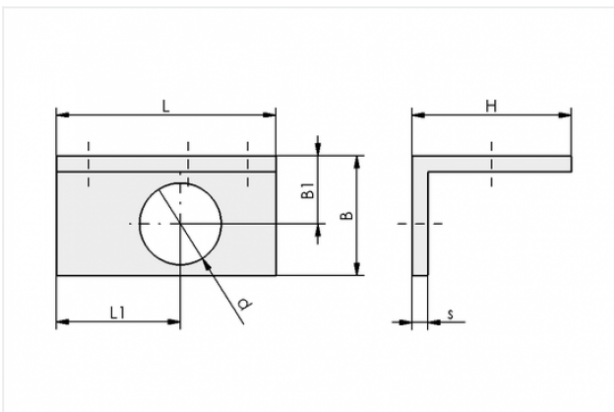

Attribute	Value
-----------	-------

B	50 mm
---	-------

B1	27 mm
----	-------

d	31 mm
---	-------

H	40 mm
---	-------

L	62 mm
---	-------

L1	40 mm
----	-------

s	5 mm
---	------

### Technical Data

Attribute	Value
-----------	-------

Weight	80 g
--------	------

### Contact to Schmalz

J. Schmalz GmbH | Johannes-Schmalz-Straße, 72293 Glatten, Deutschland | +49 7443 2403-102 | [customercenter@schmalz.de](mailto:customercenter@schmalz.de)

---

## Accessories



### **SCHE 38-18.5x5 ST VZ**

Part no. 10.01.03.06140

Washer with shoulder

External diameter D: 38 mm

Internal diameter d: 18.5 mm

Length L1: 5 mm

Material: Steel

Surface: galvanised