

Double-Blank-Detection

<https://www.schmalz.com/10.01.04.00415>



DBD 100x189 80 M42

Part no.: 10.01.04.00415

Homepage > Vacuum Technology for Automation > Vacuum Components > Mounting Elements > Jointed Mountings > Holders for Double-Blank Sensors DBD > DBD 100x189 80 M42

Holder for double-blank sensors for reliable detection of individual sheets during destacking



External diameter D: 100 mm
Height H: 189 mm
Spring stroke Z: 80 mm
for: M42-Sensors

Design Data

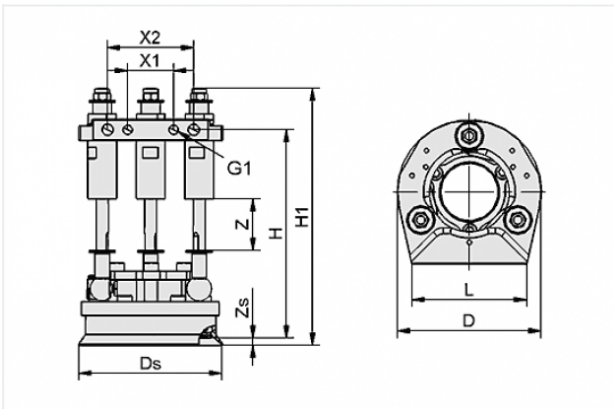

Attribute	Value
-----------	-------

D	100 mm
Ds	99.5 mm
G1	M8-F
H	189 mm
H1	223 mm
L	80 mm
X1	32 mm
X2	60 mm
Z	80 mm

Contact to Schmalz

J. Schmalz GmbH | Johannes-Schmalz-Straße, 72293 Glatten, Deutschland | +49 7443 2403-102 | customercenter@schmalz.de

Technical Data

Attribute	Value
Weight	1105 g

Spare Parts



SR-DBD 100 NBR-60

Part no. 10.01.01.12591

Suction ring for double blank detection

Size: 100

Material: Perbunan NBR 60±5ShA

Accessories



HTS-A2 DBD

Part no. 10.01.04.00411

Holder system

Cross-beam connection:

Bolt with slot Ø19mm

for: Double-Blank-Detection



HTS DBD QC1-PL

Part no. 10.01.04.00412

Holder system

for: Double-Blank-Detection

Size: QC1-PL



HTS-A2 DBD QC1-A

Part no. 10.01.04.00413

Holder system

Cross-beam connection:

Bolt with slot \varnothing 19mm

for: Double-Blank-Detection

Size: QC1-A