

# Sealing ring (f. screwing)

DR G1/2 PA

Part no.: 10.07.08.00023

<https://www.schmalz.com/10.07.08.00023>



Homepage > Vacuum Technology for Automation > Vacuum Components > Filters and Connections > Hoses and Connectors > Sealing Rings DR > DR G1/2 PA

## Sealing ring



for: G1/2"  
External diameter D: 26 mm  
Internal diameter d: 21.5 mm  
Material: Polyamide

## Design Data

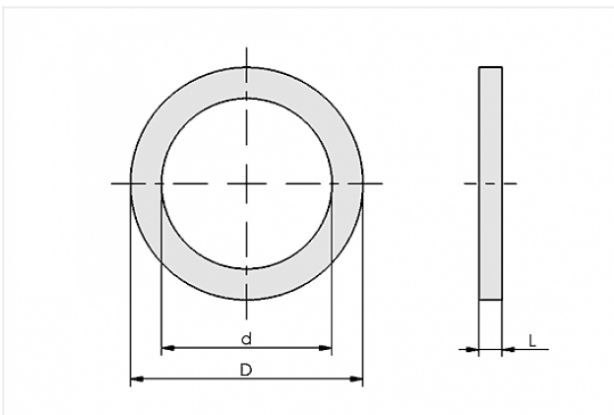

Attribute	Value
-----------	-------

d	21.5 mm
---	---------

D	26 mm
---	-------

L	1.5 mm
---	--------

## Technical Data

Attribute	Value
-----------	-------

Material	Polyamide
----------	-----------

Weight	1 g
--------	-----

## Contact to Schmalz

J. Schmalz GmbH | Johannes-Schmalz-Straße, 72293 Glatten, Deutschland | +49 7443 2403-102 | [customercenter@schmalz.de](mailto:customercenter@schmalz.de)



---

---

[Contact to Schmalz](#)

J. Schmalz GmbH | Johannes-Schmalz-Straße, 72293 Glatten, Deutschland | +49 7443 2403-102 |  
customercenter@schmalz.de