

Sealing ring

DR 62/42x5 MOS SI-15

Part no.: 10.01.06.02617

<https://www.schmalz.com/10.01.06.02617>



Homepage > Vacuum Technology for Automation > Vacuum Components > Vacuum Suction Cups > Accessories Vacuum Suction Cups > Sealing Rings DR-MOS SI > DR 62/42x5 MOS SI-15

Gasket made from special foam for optimal sealing of structured surfaces



External diameter D: 62 mm
Internal diameter d: 42 mm
Height H: 5 mm
Material-Type: Foam rubber
Sealing material: Silicone SI
Material hardness: 15 °Sh

Design Data

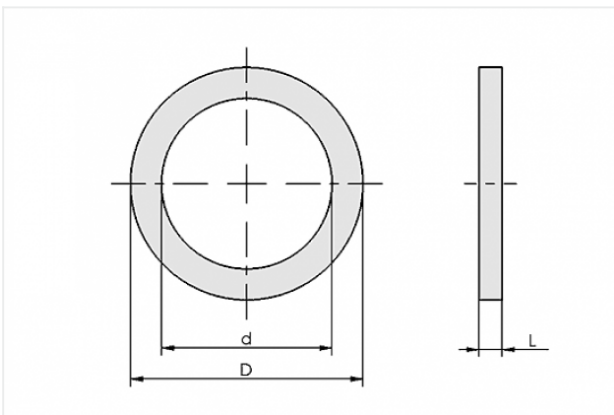

Attribute	Value
-----------	-------

d	42 mm
D	62 mm
L	5 mm

Technical Data

Attribute	Value
Material-Type	Foam rubber
Temperature resistance	180 °C

Contact to Schmalz

J. Schmalz GmbH | Johannes-Schmalz-Straße, 72293 Glatten, Deutschland | +49 7443 2403-102 | customercenter@schmalz.de



Attribute	Value
Colour	beige
Weight	0.3 g
