

Filter disc

FD 44 120

Part no.: 10.01.06.02573

<https://www.schmalz.com/10.01.06.02573>



Homepage > Vacuum Technology for Automation > Vacuum Components > Vacuum Suction Cups > Accessories Vacuum Suction Cups > Filter

Discs FD > FD 44 120

Filter disc



External diameter D: 44 mm
Filter pore size: 120 µm
for: Bellows suction pad
Size: FG52

Design Data

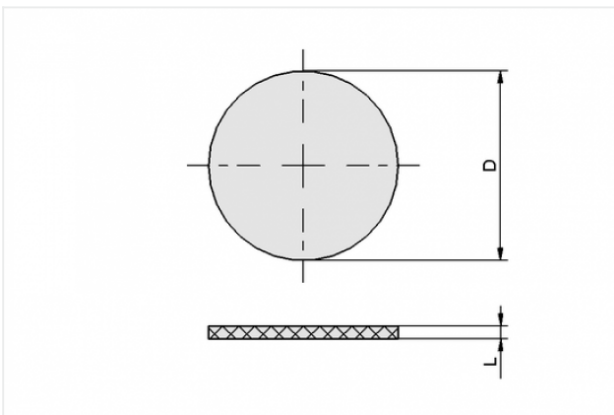

Attribute	Value
D	44 mm
L	1.5 mm

Technical Data

Attribute	Value
Size	FG52
Material	Polyethylene

Contact to Schmalz

J. Schmalz GmbH | Johannes-Schmalz-Straße, 72293 Glatten, Deutschland | +49 7443 2403-102 | customercenter@schmalz.de



Attribute	Value
Filter pore size	120 µm
Weight	1.4 g
