

# Filter disc

## FD 30 120

Part no.: 10.01.06.02568

<https://www.schmalz.com/10.01.06.02568>



Homepage > Vacuum Technology for Automation > Vacuum Components > Vacuum Suction Cups > Accessories Vacuum Suction Cups > Filter

Discs FD > FD 30 120

## Filter disc



External diameter D: 30 mm  
Filter pore size: 120 µm  
for: Bellows suction pad  
Size: FGA33

## Design Data

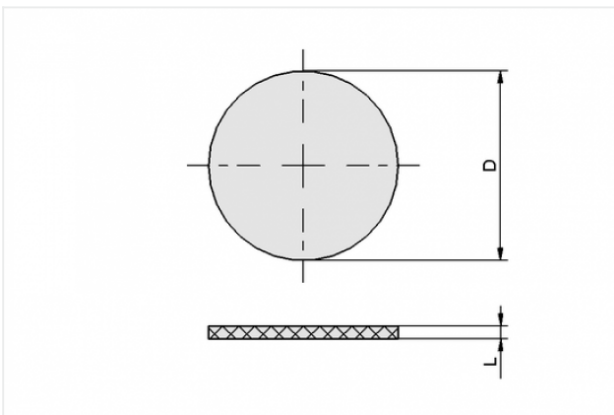

Attribute	Value
D	30 mm
L	1.5 mm

## Technical Data

Attribute	Value
Size	FGA33
Material	Polyethylene

### Contact to Schmalz

J. Schmalz GmbH | Johannes-Schmalz-Straße, 72293 Glatten, Deutschland | +49 7443 2403-102 | [customercenter@schmalz.de](mailto:customercenter@schmalz.de)



Attribute	Value
Filter pore size	120 µm
Weight	0.6 g

---

---