

# Protection Cover PC 400

<https://www.schmalz.com/10.01.01.13093>



Part no.: 10.01.01.13093

Homepage > Vacuum Technology for Automation > Vacuum Components > Vacuum Suction Cups > Accessories Vacuum Suction Cups >

Protection Covers PC > PC 400

## Cover for suction cup



Size: 400

## Design Data

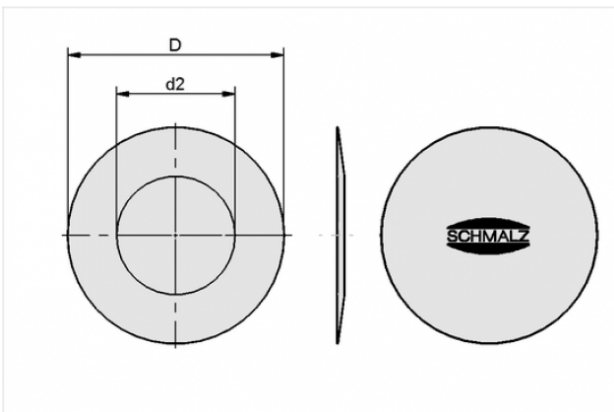

Attribute	Value
d2	200 mm
D	400 mm

## Technical Data

Attribute	Value
Size	400
Weight	48.4 g

### Contact to Schmalz

J. Schmalz GmbH | Johannes-Schmalz-Straße, 72293 Glatten, Deutschland | +49 7443 2403-102 | [customercenter@schmalz.de](mailto:customercenter@schmalz.de)

**Note:**

- Suction pad protection covers PC are designed for the use with suction pads and suction plates that are out of use. They cannot be used during handling.

---

---