

Flat suction cup (round)

<https://www.schmalz.com/10.01.01.00795>



SGPN 40 NK-40 G1/4-AG

Part no.: 10.01.01.00795

Homepage > Vacuum Technology for Automation > Vacuum Components > Vacuum Suction Cups > Suction Cups for Plastic Films and Paper >

Flat Suction Cups SGPN > SGPN 40 NK-40 G1/4-AG

Flat suction cup (round) for careful gripping of paper, plastic film, etc.



Size: 40

Suction cup material:

Natural Rubber NK

Material hardness: 40 °Sh

Nipple material: Aluminium

Vacuum connection: G1/4-M

Design Data

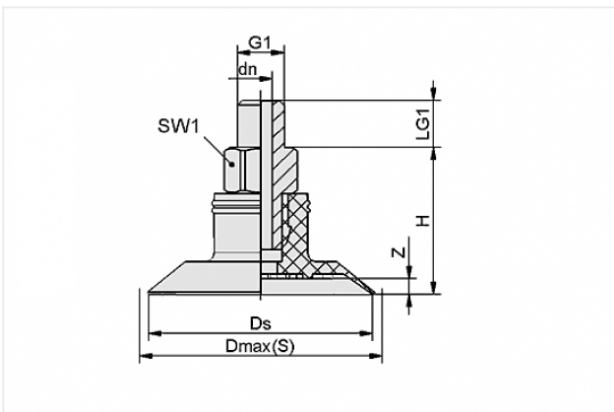

Attribute	Value
-----------	-------

dn	5 mm
----	------

Dmax(S)	42 mm
---------	-------

Ds	40 mm
----	-------

G1	G1/4"-M
----	---------

H	25.6 mm
---	---------

LG1	10 mm
-----	-------

SW1	17 mm
-----	-------

Z	2.3 mm
---	--------

Technical Data

Contact to Schmalz

J. Schmalz GmbH | Johannes-Schmalz-Straße, 72293 Glatten, Deutschland | +49 7443 2403-102 | customercenter@schmalz.de

Attribute	Value
Suction force	33 N
Volume	3.8 cm ³
Internal hose diameter (recom.)	4 mm
Size	40
Number of folds	0
Suction cup material	Natural Rubber NK
Material hardness	40 °Sh
Weight	13.2 g
Product family	SGPN

Note:

- Suction force: The specified suction forces are theoretical values at a vacuum of -0.6 bar and with a smooth, dry workpiece surface - they do not include a safety factor
- Hose diameter: The recommended hose diameter refers to a hose length of approx. 2 m

Spare Parts



SA-NIP N035 G1/4-AG DN550

Part no. 10.01.01.00822

Suction cup connection nipple

Nipple: N 035

Thread G1: G1/4-M

Overall length: 28 mm

Fitting length: 5 mm

Nominal size: 5,50 mm

Material: Aluminium

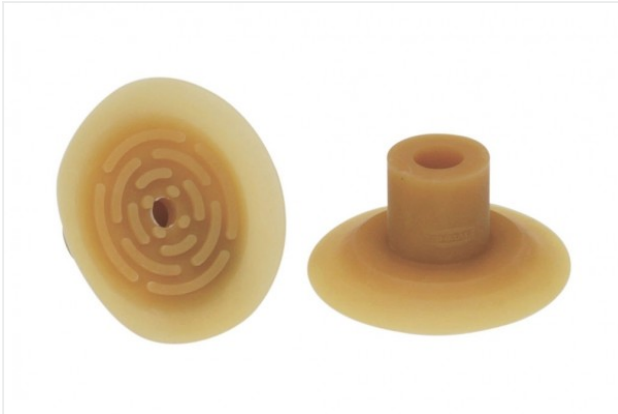

SGP 40 NK-40 N035

Part no. 10.01.01.00789

Flat suction cup (round) for careful gripping of paper, plastic film, etc.

Size: 40

Suction cup material:

Natural Rubber NK

Material hardness: 40 °Sh