

# Bellows suction cup (rectangular)

<https://www.schmalz.com/10.01.06.02286>



## FSGB-R 80x50 SI-50 G1/4-AG

Part no.: 10.01.06.02286

Homepage > Vacuum Technology for Automation > Vacuum Components > Vacuum Suction Cups > Suction Cups for Packaging > Bellows Suction

Cups FSGB-R (Rectangular) > FSGB-R 80x50 SI-50 G1/4-AG

### Bellows suction cup (rectangular)



Dimensions (LxB): 80 x 50 mm  
 Suction cup material: Silicone SI  
 Material hardness: 50 °Sh  
 Number of folds: 3.5  
 Nipple material: Aluminium  
 Vacuum connection: G1/4-M

### Design Data

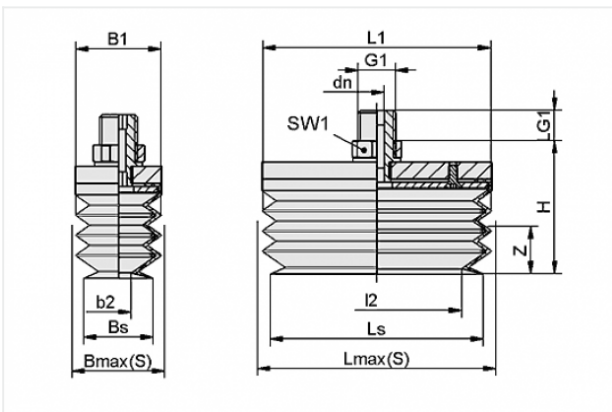

Attribute	Value
b2	29 mm
B1	44 mm
Bmax(S)	54 mm
Bs	44 mm
dn	5 mm
G1	G1/4"-M
H	57 mm
l2	59 mm
L1	74 mm
LG1	10.5 mm
Lmax(S)	84 mm
Ls	74 mm
SW1	17 mm

### Contact to Schmalz

J. Schmalz GmbH | Johannes-Schmalz-Straße, 72293 Glatten, Deutschland | +49 7443 2403-102 | [customercenter@schmalz.de](mailto:customercenter@schmalz.de)

Attribute	Value
Z	12.5 mm

---

## Technical Data

Attribute	Value
Suction force	92 N
Volume	80 cm <sup>3</sup>
Curve radius (min) (convex)	21 mm
Internal hose diameter (recom.)	9 mm
Dimensions (LxB)	80 x 50 mm
Number of folds	3.5
Suction cup material	Silicone SI
Material hardness	50 °Sh
Weight	106 g
Product family	FSGB-R

### Note:

- Suction force: The specified suction forces are theoretical values at a vacuum of -0.6 bar and with a smooth, dry workpiece surface - they do not include a safety factor
- Hose diameter: The recommended hose diameter refers to a hose length of approx. 2 m

---

## Spare Parts

### Contact to Schmalz

**FGB-R 80x50 SI-50**

Part no. 10.01.06.01114

Bellows suction cup (rectangular)

Dimensions (LxB): 80 x 50 mm

Suction cup material: Silicone SI

Material hardness: 50 °Sh

Number of folds: 3.5

**Accessories****ST-RAHM 76x46 1**

Part no. 10.01.06.02280

Supporting frame

Length L: 76 mm

Width B: 46 mm

Diameter: 1 mm