

Bell suction cup (round)

<https://www.schmalz.com/10.01.01.12267>



SAG 60 NBR-60 G1/4-IG

Part no.: 10.01.01.12267

Homepage > Vacuum Technology for Automation > Vacuum Components > Vacuum Suction Cups > Suction Cups for Handling Sheet Metal > Bell-Shaped Suction Cups SAG > SAG 60 NBR-60 G1/4-IG

Bell suction cup (round) for best adaptation to strongly curved surfaces



Size: 60
Suction cup material:
Nitrile rubber NBR
Material hardness: 60 °Sh
Vacuum connection: G1/4-F
Nipple material: Aluminium

Design Data

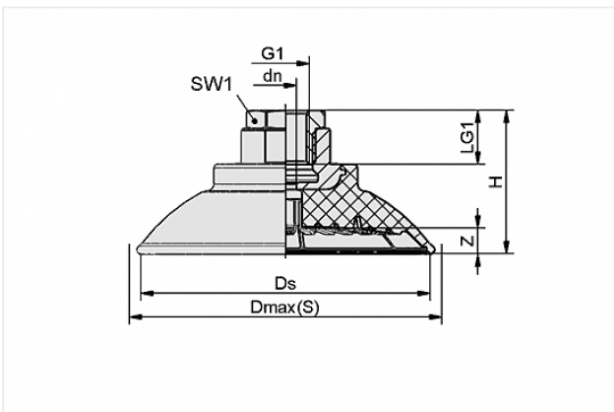

Attribute	Value
-----------	-------

dn	6 mm
Dmax(S)	70.5 mm
Ds	63.5 mm
G1	G1/4"-F
H	36 mm
LG1	15 mm
SW1	22 mm
Z	10.6 mm

Technical Data

Contact to Schmalz

J. Schmalz GmbH | Johannes-Schmalz-Straße, 72293 Glatten, Deutschland | +49 7443 2403-102 | customercenter@schmalz.de

Attribute	Value
Suction force	122 N
Lateral force	153 N
Lateral force (oily surface)	80 N
Volume	22 cm ³
Curve radius (min) (convex)	50 mm
Internal hose diameter (recom.)	6 mm
Size	60
Suction cup material	Nitrile rubber NBR
Material hardness	60 °Sh
Weight	44.9 g
Number of folds	0
