

Bell suction cup (round)

<https://www.schmalz.com/10.01.01.12162>



SAG 45 NBR-60 RA

Part no.: 10.01.01.12162

Homepage > Vacuum Technology for Automation > Vacuum Components > Vacuum Suction Cups > Suction Cups for Handling Sheet Metal > Bell-Shaped Suction Cups SAG > SAG 45 NBR-60 RA

Bell suction cup (round) for best adaptation to strongly curved surfaces



Size: 45
Suction cup material:
Nitrile rubber NBR
Material hardness: 60 °Sh
Vacuum connection:
Rectangular adapter
Nipple material: Aluminium

Design Data

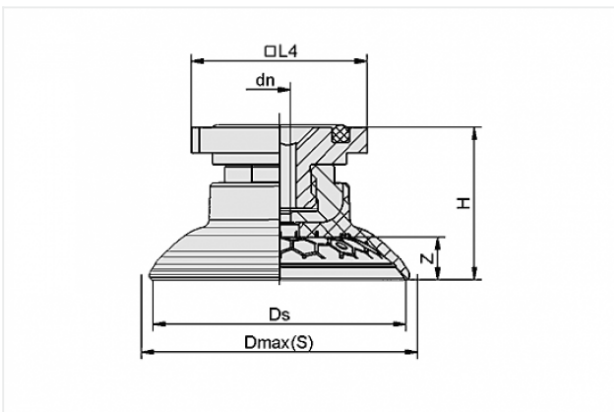

Attribute	Value
-----------	-------

dn	4 mm
Dmax(S)	51.5 mm
Ds	47 mm
H	27.7 mm
L4	31.8 mm
Z	7.8 mm

Technical Data

Attribute	Value
Suction force	68 N
Lateral force	61 N

Contact to Schmalz

J. Schmalz GmbH | Johannes-Schmalz-Straße, 72293 Glatten, Deutschland | +49 7443 2403-102 | customercenter@schmalz.de

Attribute	Value
Lateral force (oily surface)	51 N
Volume	8 cm ³
Curve radius (min) (convex)	40 mm
Internal hose diameter (recom.)	4 mm
Size	45
Suction cup material	Nitrile rubber NBR
Material hardness	60 °Sh
Weight	27.2 g
Number of folds	0
