

Bellows suction cup (round)

<https://www.schmalz.com/10.01.06.03525>



SPB4 30 SI-55 G3/8-IG

Part no.: 10.01.06.03525

Homepage > Vacuum Technology for Automation > Vacuum Components > Vacuum Suction Cups > Suction Cups for Packaging > Bellows Suction Cups SPB4 (4.5 Folds) > SPB4 30 SI-55 G3/8-IG

Bellows suction cup (round) for very uneven workpieces



Size: 30
Suction cup material: Silicone SI
Material hardness: 55 °Sh
Thread G1: G3/8-F
Number of folds: 4.5

Design Data

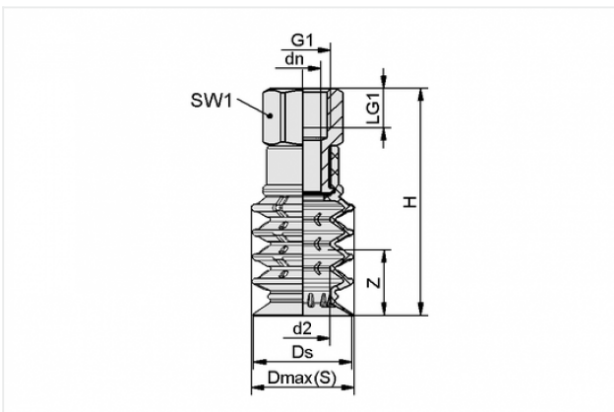

Attribute	Value
d2	17 mm
dn	11 mm
Dmax(S)	31.5 mm
Ds	30.2 mm
G1	G3/8"-F
H	69.5 mm
LG1	12 mm
SW1	22 mm
Z	20 mm

Contact to Schmalz

J. Schmalz GmbH | Johannes-Schmalz-Straße, 72293 Glatten, Deutschland | +49 7443 2403-102 | customercenter@schmalz.de

Technical Data

Attribute	Value
Suction force	16 N
Pull-off force	22 N
Volume	15.61 cm ³
Internal hose diameter (recom.)	9 mm
Number of folds	4.5
Suction cup material	Silicone SI
Material hardness	55 °Sh
Weight	27.7 g
Product family	SPB4

Spare Parts



SC 080 G3/8-IG

Part no. 10.01.06.02594

Connection element for suction cup SchmalzConnector

Connection geometry: 080

Vacuum connection: G3/8-F

Overall length: 32 mm

Fitting length: 17.5 mm

Nominal diameter dn: 11 mm

**SPB4 30 SI-55 SC080**

Part no. 10.01.06.02589

Bellows suction cup (round) with 4.5 folds for process reliable handling of pouches and flex. prod.

Size: 30

Suction cup material: Silicone SI

Material hardness: 55 °Sh

Material characteristics:

FDA-compatible

Number of folds: 4.5

Accessories**SIEB 17x0.8 MS-A2 103 0.103/0.07**

Part no. 10.07.01.00320

Screen

External diameter D: 17 mm

Length L: 0.8 mm

Material: Brass / Stainless steel

Filter pore size: 103 µm

Mesh: 0.103 mm

Wire size: 0.07 mm

**SSB 16-27 ST-VZ**

Part no. 10.07.10.00002

Hose clamp for securing smooth hoses

Clamping range: 16.0 ... 27.0 mm

Material: Steel galvanised



SPI 24 PE

Part no. 10.01.06.02855

Insert disc for preventing film from being drawn in

Size: 24

Material: Polyethylene

Application: SPB4 30