

Schmalz Pad Insert

<https://www.schmalz.com/10.01.06.02855>



SPI 24 PE

Part no.: 10.01.06.02855

Homepage > Vacuum Technology for Automation > Vacuum Components > Vacuum Suction Cups > Accessories Vacuum Suction Cups > Suction Cup Inserts SPI (for SPB4) > SPI 24 PE

Insert disc for preventing film from being drawn in



Size: 24
Material: Polyethylene
Application: SPB4 30

Design Data

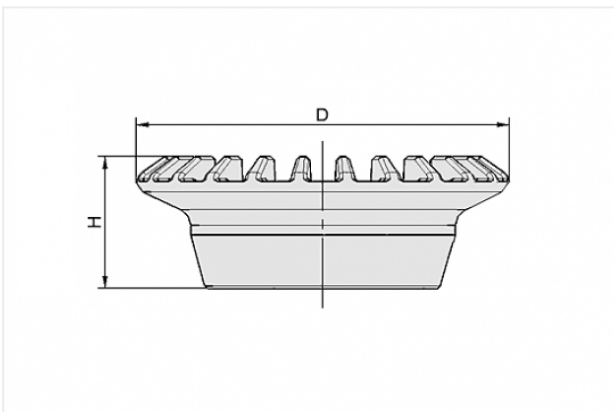

Attribute	Value
D	24 mm
H	9.5 mm

Technical Data

Attribute	Value
Application	SPB4 30
Material	Polyethylene

Contact to Schmalz

J. Schmalz GmbH | Johannes-Schmalz-Straße, 72293 Glatten, Deutschland | +49 7443 2403-102 | customercenter@schmalz.de



Attribute	Value
Weight	0.8 g
