

Bellows suction cup (round)

<https://www.schmalz.com/10.01.06.03224>



SPB2 40 SI-55 SW80 P

Part no.: 10.01.06.03224

Homepage > Vacuum Technology for Automation > Vacuum Components > Vacuum Suction Cups > Suction Cups for Packaging > Bellows Suction Cups SPB2 P (2.5 Folds) (W. Flow Resistance) > SPB2 40 SI-55 SW80 P

Bellows suction cup (round) with 2.5 corr. for dynamic handling of cardboard and rigid packaging



Size: 40
Suction cup material: Silicone SI
Material hardness: 55 °Sh
Flow resistance SW: 0.8 mm
Number of folds: 2.5
Shape: Push In

Design Data

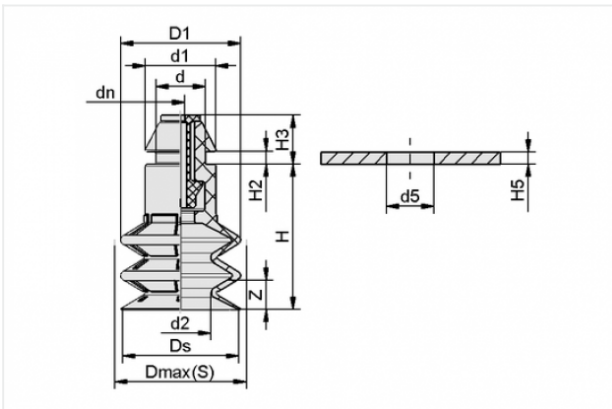

Attribute	Value
-----------	-------

d	12.5 mm
---	---------

d1	15.7 mm
----	---------

d2	17.8 mm
----	---------

d5	11.5 mm
----	---------

dn	0.8 mm
----	--------

D1	43.5 mm
----	---------

Dmax(S)	44.6 mm
---------	---------

Ds	42.7 mm
----	---------

H	47 mm
---	-------

H2	2.2 mm
----	--------

H3	8.2 mm
----	--------

H5	2 mm
----	------

Contact to Schmalz

J. Schmalz GmbH | Johannes-Schmalz-Straße, 72293 Glatten, Deutschland | +49 7443 2403-102 | customercenter@schmalz.de

Attribute	Value
Z	20 mm

Technical Data

Attribute	Value
Suction force	14.9 N
Pull-off force	40 N
Volume	22 cm ³
Curve radius (min) (convex)	75 mm
Size	40
Number of folds	2.5
Suction cup material	Silicone SI
Material hardness	55 °Sh
Weight	18.5 g
Product family	SPB2

Spare Parts



SW 80 P

Part no. 10.05.04.00090

Flow resistor for reduction of the volume flow rate

Nominal size: 0.80 mm

Shape: Push In

Length: 15.5 mm

Material: Polyoxymethylene

Contact to Schmalz

**SPB2 40 SI-55 P**

Part no. 10.01.06.03126

Bellows suction cup (round) with 2.5 corr. for dynamic handling of cardboard and rigid packaging

Size: 40

Suction cup material: Silicone SI

Material hardness: 55 °Sh

Number of folds: 2.5

Shape: Push In

Accessories**FD 34 120**

Part no. 10.01.06.02572

Filter disc

External diameter D: 34 mm

Filter pore size: 120 µm

for: Bellows suction pad

Size: FG42