

# Bellows suction cup (round)

<https://www.schmalz.com/10.01.06.03223>



SPB2 20 SI-40 SW150 P

Part no.: 10.01.06.03223

Homepage > Vacuum Technology for Automation > Vacuum Components > Vacuum Suction Cups > Suction Cups for Packaging > Bellows Suction Cups SPB2 P (2.5 Folds) (W. Flow Resistance) > SPB2 20 SI-40 SW150 P

## Bellows suction cup (round) with 2.5 corr. for dynamic handling of cardboard and rigid packaging



Size: 20  
Suction cup material: Silicone SI  
Material hardness: 40 °Sh  
Flow resistance SW: 1.5 mm  
Number of folds: 2.5  
Shape: Push In

### Design Data

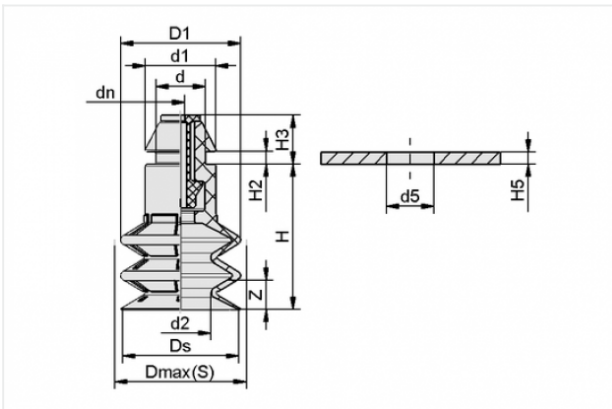

Attribute	Value
-----------	-------

d	8.5 mm
---	--------

d1	11.8 mm
----	---------

d2	10.2 mm
----	---------

d5	7.9 mm
----	--------

dn	1.5 mm
----	--------

D1	20 mm
----	-------

Dmax(S)	20.5 mm
---------	---------

Ds	19.6 mm
----	---------

H	24.3 mm
---	---------

H2	2.2 mm
----	--------

H3	8.2 mm
----	--------

H5	2 mm
----	------

### Contact to Schmalz

J. Schmalz GmbH | Johannes-Schmalz-Straße, 72293 Glatten, Deutschland | +49 7443 2403-102 | [customercenter@schmalz.de](mailto:customercenter@schmalz.de)

Attribute	Value
Z	9 mm

## Technical Data

Attribute	Value
Suction force	4.9 N
Pull-off force	8 N
Volume	2.5 cm <sup>3</sup>
Curve radius (min) (convex)	25 mm
Size	20
Number of folds	2.5
Suction cup material	Silicone SI
Material hardness	40 °Sh
Weight	2.5 g
Product family	SPB2

## Spare Parts



### SW 150 P

Part no. 10.05.04.00093

Flow resistor for reduction of the volume flow rate

Nominal size: 1.50 mm

Shape: Push In

Length: 15.5 mm

Material: Polyoxymethylene

## Contact to Schmalz

**SPB2 20 SI-40 P**

Part no. 10.01.06.03125

Bellows suction cup (round) with 2.5 corr. for dynamic handling of cardboard and rigid packaging

Size: 20

Suction cup material: Silicone SI

Material hardness: 40 °Sh

Number of folds: 2.5

Shape: Push In

**Accessories****FD 16 120**

Part no. 10.01.06.02565

Filter disc

External diameter D: 16 mm

Filter pore size: 120 µm

for: Bellows suction pad

Size: FG20/FGA20