

Connection element for suction cup SchmalzConnector

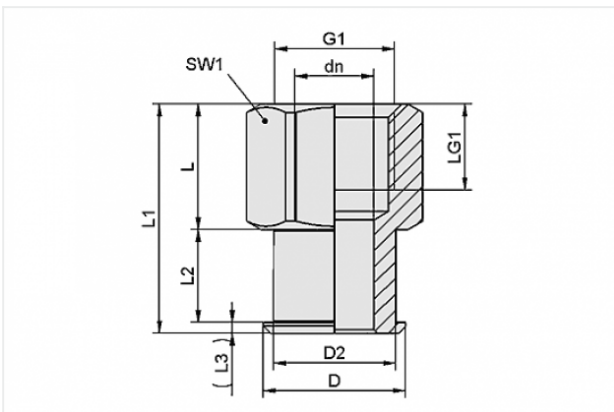

Connection geometry: 090
Vacuum connection: G1/2-F
Overall length: 37.5 mm
Fitting length: 21.5 mm
Nominal diameter dn: 15 mm

Design Data



Attribute	Value
dn	15 mm
D	25 mm
D2	21 mm
G1	G1/2"-F
L	21.5 mm
L1	37.5 mm
L2	14 mm
L3	2 mm
LG1	16 mm
SW1	27 mm

Technical Data

Attribute	Value
Connection geometry	090
Material	Aluminium
Weight	27.4 g
