

Connection element for suction cup SchmalzConnector

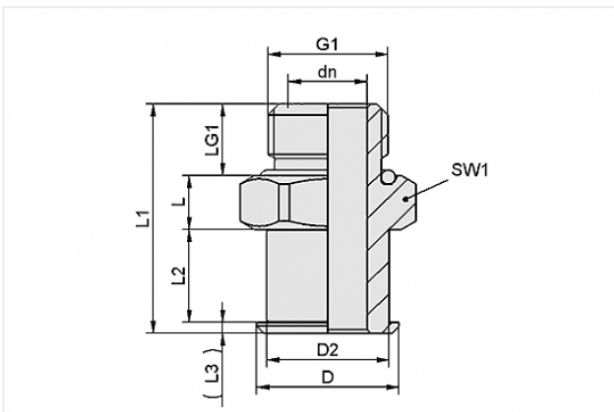

Connection geometry: 090
 Vacuum connection: G1/2-M
 Overall length: 37.5 mm
 Fitting length: 7.5 mm
 Nominal diameter dn: 15 mm

Design Data



Attribute	Value
dn	15 mm
D	25 mm
D2	21 mm
G1	G1/2"-M
L	7.5 mm
L1	37.5 mm
L2	14 mm
L3	2 mm
LG1	14 mm
SW1	27 mm

Technical Data

Attribute	Value
Connection geometry	090
Material	Aluminium
Weight	21.5 g
