

# Bellows suction cup (round)

<https://www.schmalz.com/10.01.06.03410>



## SPB2 25 ED-65 SC040

Part no.: 10.01.06.03410

Homepage > Vacuum Technology for Automation > Vacuum Components > Vacuum Suction Cups > Suction Cups for Packaging > SPB2 25 ED-65 SC040

## Bellows suction cup (round) with 2.5 corr. for dynamic handling of cardboard and rigid packaging



Size: 25

Suction cup material: Elastodur

Material hardness: 65 °Sh

Number of folds: 2.5

### Design Data

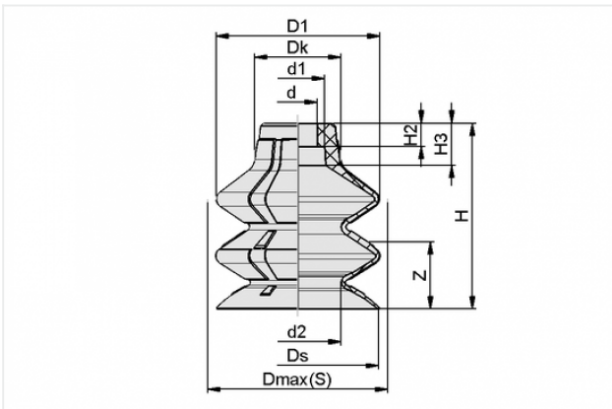

Attribute	Value
-----------	-------

d	7.5 mm
---	--------

d1	10.5 mm
----	---------

d2	14.5 mm
----	---------

D1	27.2 mm
----	---------

Dk	15.5 mm
----	---------

Dmax(S)	28 mm
---------	-------

Ds	26.4 mm
----	---------

H	30.9 mm
---	---------

H2	4.6 mm
----	--------

H3	7.8 mm
----	--------

Z	17 mm
---	-------

### Contact to Schmalz

J. Schmalz GmbH | Johannes-Schmalz-Straße, 72293 Glatten, Deutschland | +49 7443 2403-102 | [customercenter@schmalz.de](mailto:customercenter@schmalz.de)

## Technical Data

Attribute	Value
Suction force	9.9 N
Pull-off force	20.1 N
Lateral force	9.1 N
Volume	7.6 cm <sup>3</sup>
Curve radius (min) (convex)	20 mm
Internal hose diameter (recom.)	4 mm
Size	25
Nipple	SC 040
Number of folds	2.5
Suction cup material	Elastodur
Material hardness	65 °Sh
Weight	3.3 g
Product family	SPB2

## Accessories



### SC 040 G1/8-AG

Part no. 10.01.06.02490

Connection element for suction cup SchmalzConnector

Connection geometry: 040

Vacuum connection: G1/8-M

Overall length: 20.2 mm

Fitting length: 6 mm

Nominal diameter dn: 4.1 mm

## Contact to Schmalz



**SC 040 G1/8-IG**

Part no. 10.01.06.02482

Connection element for suction cup SchmalzConnector

Connection geometry: 040

Vacuum connection: G1/8-F

Overall length: 20.7 mm

Fitting length: 14 mm

Nominal diameter dn: 4.1 mm