

Bell suction cup (oval)

SAOXM 100x40 ED-85 G3/8-AG

<https://www.schmalz.com/10.01.24.00038>



Part no.: 10.01.24.00038

Homepage > Vacuum Technology for Automation > Vacuum Components > Vacuum Suction Cups > Suction Cups for Handling Sheet Metal > Bell-Shaped Suction Cups SAOXM (Oval) > SAOXM 100x40 ED-85 G3/8-AG

High-Speed bell shaped suction cup for (oval) very dynamic handling of smooth and oily workpieces



Dimensions (LxB): 100 x 40 mm
 Suction cup material: Elastodur
 Material hardness: 85 °Sh
 Vacuum connection: G3/8-M
 Nipple material: Aluminium
 Additional feature: Friction Disc

Design Data

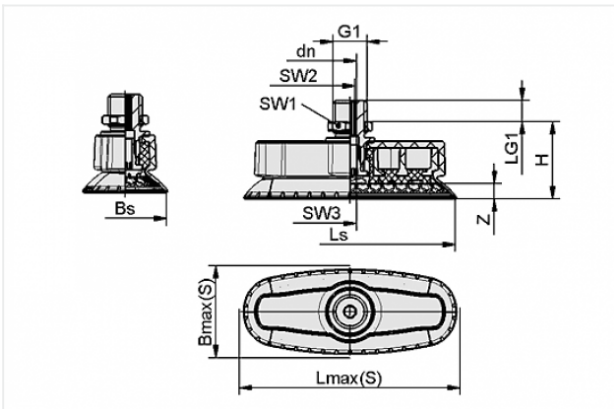

Attribute	Value
Bmax(S)	51 mm
Bs	41.6 mm
dn	5.1 mm
G1	G3/8"-M
H	37.7 mm
LG1	8 mm
Lmax(S)	109 mm
Ls	101.8 mm
SW1	19 mm
SW2	5 mm
SW3	6 mm
Z	7.3 mm

Contact to Schmalz

J. Schmalz GmbH | Johannes-Schmalz-Straße, 72293 Glatten, Deutschland | +49 7443 2403-102 | customercenter@schmalz.de

Technical Data

Attribute	Value
Suction force	173 N
Lateral force	135 N
Lateral force (oily surface)	156 N
Volume	24 cm ³
Curve radius (min) (convex)	32 mm
Internal hose diameter (recom.)	6 mm
Dimensions (LxB)	100 x 40 mm
Suction cup material	Elastodur
Material hardness	85 °Sh
Weight	76.3 g
Product family	SAOXM
