

# Bell suction cup (oval)

## SAOXM 80x30 ED-85 G3/8-IG

<https://www.schmalz.com/10.01.24.00018>



Part no.: 10.01.24.00018

Homepage > Vacuum Technology for Automation > Vacuum Components > Vacuum Suction Cups > Suction Cups for Handling Sheet Metal > Bell-Shaped Suction Cups SAOXM (Oval) > SAOXM 80x30 ED-85 G3/8-IG

### High-Speed bell shaped suction cup for (oval) very dynamic handling of smooth and oily workpieces



Dimensions (LxB): 80 x 30 mm  
 Suction cup material: Elastodur  
 Material hardness: 85 °Sh  
 Vacuum connection: G3/8-F  
 Nipple material: Aluminium  
 Additional feature: Friction Disc

#### Design Data

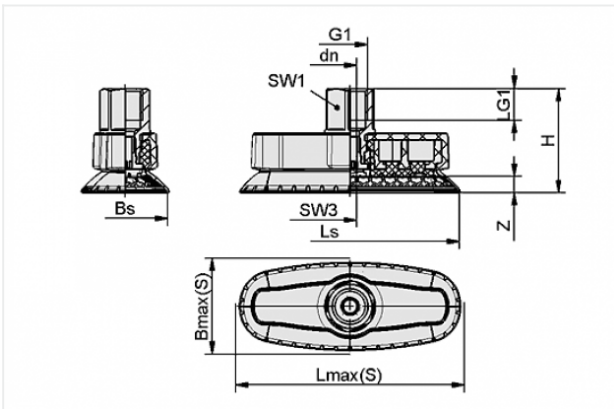

Attribute	Value
Bmax(S)	41.5 mm
Bs	31.9 mm
dn	5.1 mm
G1	G3/8"-F
H	39.1 mm
LG1	12 mm
Lmax(S)	88 mm
Ls	82.1 mm
SW1	22 mm
SW3	5 mm
Z	6 mm

#### Contact to Schmalz

J. Schmalz GmbH | Johannes-Schmalz-Straße, 72293 Glatten, Deutschland | +49 7443 2403-102 | [customercenter@schmalz.de](mailto:customercenter@schmalz.de)

## Technical Data

Attribute	Value
Suction force	105 N
Lateral force	110 N
Lateral force (oily surface)	134 N
Volume	13 cm <sup>3</sup>
Curve radius (min) (convex)	20 mm
Internal hose diameter (recom.)	4 mm
Dimensions (LxB)	80 x 30 mm
Suction cup material	Elastodur
Material hardness	85 °Sh
Weight	40.1 g
Product family	SAOXM

## Spare Parts



### SC-I 045 AR-FDC

Part no. 10.01.24.00010

Schmalz-Connector Einleger

Size: 045

Shape: Anti Rot / Friction Elem

Application: SAOXM 80x30



**SC-A 045-AR G3/8-IG L**

Part no. 10.01.06.03132

Schmalz-Connector upper part

Connection geometry: 045-AR

Thread G1: G3/8-F

Fitting length: 17.2 mm

Construction: Self Locking



**SC-S 045 L**

Part no. 10.01.06.02740

Schmalz-Connector lower part

Size: 045

Construction: Self Locking



**SAOXM 80x30 ED-85 SC045-AR**

Part no. 10.01.24.00002

-

Dimensions (LxB): 80 x 30 mm

Suction cup material: Elastodur

Material hardness: 85 °Sh