

Bell suction cup (round)

<https://www.schmalz.com/10.01.19.00028>



SAXM 50 ED-85 RA

Part no.: 10.01.19.00028

Homepage > Vacuum Technology for Automation > Vacuum Components > Vacuum Suction Cups > Suction Cups for Handling Sheet Metal > Bell-Shaped Suction Cups SAXM > SAXM 50 ED-85 RA

Bell suction cup (round) for best adaptation to strongly curved surfaces



Size: 50
Suction cup material: Elastodur
Material hardness: 85 °Sh
Vacuum connection:
Rectangular adapter
Nipple material: Aluminium

Design Data

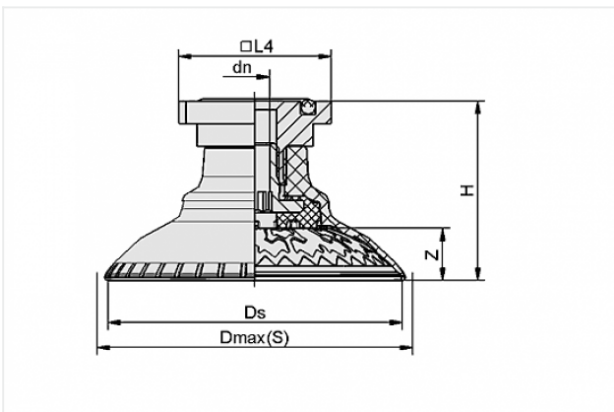

Attribute	Value
-----------	-------

dn	6.1 mm
Dmax(S)	58.4 mm
Ds	51.5 mm
H	35.1 mm
L4	31.8 mm
Z	8.4 mm

Technical Data

Attribute	Value
Suction force	109 N
Lateral force	58 N

Contact to Schmalz

J. Schmalz GmbH | Johannes-Schmalz-Straße, 72293 Glatten, Deutschland | +49 7443 2403-102 | customercenter@schmalz.de

Attribute	Value
Lateral force (oily surface)	110 N
Volume	14.4 cm ³
Curve radius (min) (convex)	25 mm
Internal hose diameter (recom.)	6 mm
Size	50
Connection	Rectangular adapter
Number of folds	0
Suction cup material	Elastodur
Material hardness	85 °Sh
Weight	38 g
Product family	SAXM

Note:

- Suction force: The specified suction forces are theoretical values at a vacuum of -0.6 bar and with a smooth, dry workpiece surface - they do not include a safety factor
- Lateral force: The specified lateral forces are values measured at a vacuum of -0.6 bar with a dry or oily, smooth, flat workpiece surface. Depending on the workpiece surface and its quality, the actual values may deviate from these values
- Hose diameter: The recommended hose diameter refers to a hose length of approx. 2 m

Spare Parts



SC-A 055 RA L

Part no. 10.01.06.02815
 Schmalz-Connector upper part
 Connection geometry: 055
 Vacuum connection:
 Rectangular adapter
 Fitting length: 9.5 mm
 Construction: Self Locking



SAXM 50 ED-85 SC055

Part no. 10.01.19.00006

High-Speed bell shaped suction cup (round) very dynamic handling of smooth and oily workpieces

Size: 50

Suction cup material: Elastodur

Material hardness: 85 °Sh



SC-S 055 FDC-L

Part no. 10.01.06.02804

Schmalz-Connector lower part

Size: 055

Construction:

Frict elem with Self lock