

Bell suction cup (round)

<https://www.schmalz.com/10.01.19.00052>



SAXM 40 ED-85 G3/8-AG

Part no.: 10.01.19.00052

Homepage > Vacuum Technology for Automation > Vacuum Components > Vacuum Suction Cups > Suction Cups for Handling Sheet Metal > Bell-Shaped Suction Cups SAXM > SAXM 40 ED-85 G3/8-AG

Bell suction cup (round) for best adaptation to strongly curved surfaces



Size: 40
Suction cup material: Elastodur
Material hardness: 85 °Sh
Vacuum connection: G3/8-M
Nipple material: Aluminium

Design Data

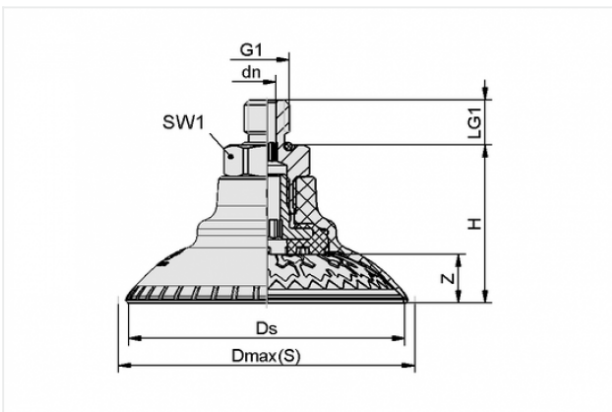

Attribute	Value
-----------	-------

dn	5.1 mm
----	--------

Dmax(S)	45.4 mm
---------	---------

Ds	41.3 mm
----	---------

G1	G3/8"-M
----	---------

H	28.1 mm
---	---------

LG1	10 mm
-----	-------

SW1	22 mm
-----	-------

Z	6.9 mm
---	--------

Technical Data

Contact to Schmalz

J. Schmalz GmbH | Johannes-Schmalz-Straße, 72293 Glatten, Deutschland | +49 7443 2403-102 | customercenter@schmalz.de

Attribute	Value
Suction force	69 N
Lateral force	38 N
Lateral force (oily surface)	71 N
Volume	7.1 cm ³
Curve radius (min) (convex)	25 mm
Internal hose diameter (recom.)	5 mm
Size	40
Connection	G3/8"-M
Number of folds	0
Suction cup material	Elastodur
Material hardness	85 °Sh
Weight	21.8 g
Product family	SAXM

Note:

- Suction force: The specified suction forces are theoretical values at a vacuum of -0.6 bar and with a smooth, dry workpiece surface - they do not include a safety factor
- Lateral force: The specified lateral forces are values measured at a vacuum of -0.6 bar with a dry or oily, smooth, flat workpiece surface. Depending on the workpiece surface and its quality, the actual values may deviate from these values
- Hose diameter: The recommended hose diameter refers to a hose length of approx. 2 m

Spare Parts



SC-A 045 G3/8-AG L

Part no. 10.01.06.02807

Schmalz-Connector upper part

Connection geometry: 045

Thread G1: G3/8-M

Fitting length: 7.7 mm

Construction: Self Locking



SAXM 40 ED-85 SC045

Part no. 10.01.19.00005

High-Speed bell shaped suction cup (round) very dynamic handling of smooth and oily workpieces

Size: 40

Suction cup material: Elastodur

Material hardness: 85 °Sh



SC-S 045 FDC-L

Part no. 10.01.06.02803

Schmalz-Connector lower part

Size: 045

Construction:

Frict elem with Self lock