

Bell suction cup (round)

<https://www.schmalz.com/10.01.19.00214>



SAX 40 ED-85 G1/4-AG

Part no.: 10.01.19.00214

Homepage > Vacuum Technology for Automation > Vacuum Components > Vacuum Suction Cups > Suction Cups for Handling Sheet Metal > Bell-Shaped Suction Cups SAX > SAX 40 ED-85 G1/4-AG

Bell suction cup (round) for best adaptation to strongly curved surfaces



Size: 40
Suction cup material: Elastodur
Material hardness: 85 °Sh
Vacuum connection: G1/4"-M
Nipple material: Aluminium

Design Data

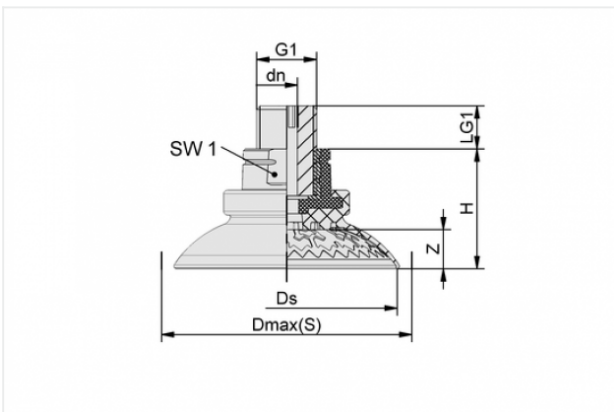

Attribute	Value
dn	6.1 mm
Dmax(S)	45.4 mm
Ds	41.3 mm
G1	G1/4"-M
H	29.3 mm
LG1	14.5 mm
SW1	22 mm
Z	7.1 mm

Technical Data

Contact to Schmalz

J. Schmalz GmbH | Johannes-Schmalz-Straße, 72293 Glatten, Deutschland | +49 7443 2403-102 | customercenter@schmalz.de

Attribute	Value
Suction force	69 N
Lateral force	49 N
Lateral force (oily surface)	71 N
Volume	8.5 cm ³
Curve radius (min) (convex)	25 mm
Size	40
Connection	G1/4"-M
Number of folds	0
Suction cup material	Elastodur
Material hardness	85 °Sh
Weight	33.5 g
Product family	SAX

***The specified suction forces are theoretical values at a vacuum of -0.6 bar and with a smooth, dry workpiece surface - they do not include a safety factor.**

****The specified lateral forces are values measured at a vacuum of -0.6 bar with a dry or oily, smooth, flat workpiece surface. Depending on the workpiece surface and its quality, the actual values may deviate from these values.**

*****The recommended hose diameter refers to a hose length of approx. 2 m.**