

Bellows suction cup (oval)

<https://www.schmalz.com/10.01.06.02442>



SAOB 60x30 HT2-65 G1/4-IG

Part no.: 10.01.06.02442

Homepage > Vacuum Technology for Automation > Vacuum Components > Vacuum Suction Cups > Bellows Suction Cups (Oval) > Bellows Suction Cups SAOB HT2 (Oval, 1.5 Folds) > SAOB 60x30 HT2-65 G1/4-IG

Bellows suction cup (oval) for best dynamics



Dimensions (LxB): 60 x 30 mm
Suction cup material:
High temp material HT2
Material hardness: 65 °Sh
Temperature resistance: 200 °C
Number of folds: 1.5
Nipple material: Brass, nickel-plated
Vacuum connection: G1/4-F

Design Data

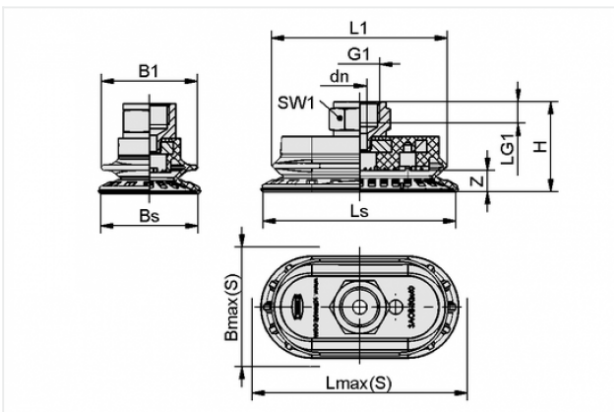

Attribute	Value
-----------	-------

B1	31 mm
Bmax(S)	33 mm
Bs	30.6 mm
dn	6 mm
G1	G1/4"-F
H	34.4 mm
L1	55.7 mm
LG1	8 mm
Lmax(S)	63 mm
Ls	60.6 mm
SW1	17 mm
Z	7 mm

Contact to Schmalz

J. Schmalz GmbH | Johannes-Schmalz-Straße, 72293 Glatten, Deutschland | +49 7443 2403-102 | customercenter@schmalz.de

Technical Data

Attribute	Value
Suction force	38 N
Pull-off force	55 N
Lateral force	56 N
Volume	9.6 cm ³
Curve radius (min) (convex)	30 mm
Internal hose diameter (recom.)	4 mm
Dimensions (LxB)	60 x 30 mm
Number of folds	1.5
Suction cup material	High temp material HT2
Material hardness	65 °Sh
Weight	44.3 g
Product family	SAOB
