

Bellows suction cup (oval)

<https://www.schmalz.com/10.01.06.00893>



SAOB 80x40 NBR-60 G1/4-IG

Part no.: 10.01.06.00893

Homepage > Vacuum Technology for Automation > Vacuum Components > Vacuum Suction Cups > Bellows Suction Cups (Oval) > Bellows Suction Cups SAOB (Oval, 1.5 Folds) > SAOB 80x40 NBR-60 G1/4-IG

Bellows suction cup (oval) for high dynamic on curved, oily surfaced workpieces



Dimensions (LxB): 80 x 40 mm
Suction cup material:
Nitrile rubber NBR
Material hardness: 60 °Sh
Nipple material: Brass, nickel-plated
Vacuum connection: G1/4-F
Number of folds: 1.5

Design Data

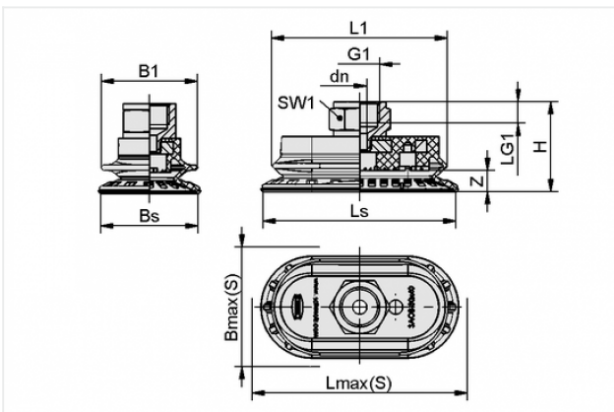

Attribute	Value
-----------	-------

B1	40 mm
Bmax(S)	43 mm
Bs	40.6 mm
dn	6 mm
G1	G1/4"-F
H	37.2 mm
L1	73.3 mm
LG1	8 mm
Lmax(S)	83 mm
Ls	80.6 mm
SW1	17 mm
Z	9 mm

Contact to Schmalz

J. Schmalz GmbH | Johannes-Schmalz-Straße, 72293 Glatten, Deutschland | +49 7443 2403-102 | customercenter@schmalz.de

Technical Data

Attribute	Value
Suction force	65 N
Pull-off force	131.7 N
Lateral force	152.8 N
Lateral force (oily surface)	73.6 N
Volume	21.8 cm ³
Curve radius (min) (convex)	25 mm
Internal hose diameter (recom.)	6 mm
Dimensions (LxB)	80 x 40 mm
Suction cup material	Nitrile rubber NBR
Material hardness	60 °Sh
Number of folds	1.5
Weight	36.3 g
Product family	SAOB

Note:

- Suction force: The specified suction forces are theoretical values at a vacuum of -0.6 bar and with a smooth, dry workpiece surface - they do not include a safety factor
- Lateral force: The specified lateral forces are values measured at a vacuum of -0.6 bar with a dry or oily, smooth, flat workpiece surface. Depending on the workpiece surface and its quality, the actual values may deviate from these values
- Hose diameter: The recommended hose diameter refers to a hose length of approx. 2 m