

Suction pad (round)

SAUG-SCG 50 SI-HD

<https://www.schmalz.com/10.01.30.00593>



Part no.: 10.01.30.00593

Homepage > Vacuum Technology for Automation > Vacuum Components > Special Grippers > Flow Grippers > Suction Cups for Flow Grippers

SCG > SAUG-SCG 50 SI-HD

Flat suction cup (round)



Size: 50

Suction cup material: Silicone SI-HD

Design Data

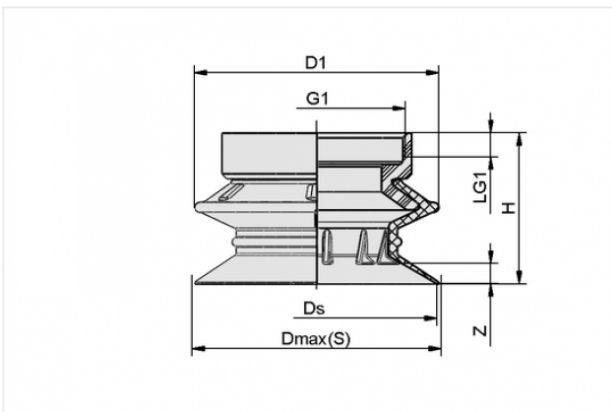

Attribute	Value
-----------	-------

D1	51 mm
----	-------

Dmax(S)	51.5 mm
---------	---------

Ds	50.3 mm
----	---------

G1	M37x1-F
----	---------

H	31.5 mm
---	---------

LG1	5 mm
-----	------

Z	4.2 mm
---	--------

Technical Data

Attribute	Value
Size	50

Contact to Schmalz

J. Schmalz GmbH | Johannes-Schmalz-Straße, 72293 Glatten, Deutschland | +49 7443 2403-102 | customercenter@schmalz.de

Attribute	Value
Number of folds	0
Suction cup material	Silicone SI-HD
Weight	16.7 g

Spare Parts



FLSA 50 SI-HD

Part no. 10.01.06.03467

Flat suction cup (round)

Size: 50

Suction cup material: Silicone SI-HD

Accessories



SCG 1xE100 A MA

Part no. 10.01.30.00092

Flow Grippers for handling sensitive components

Number of ejectors: 1

Performance class: E100

with: Blow-off function

Mounting: Assembly axially



SCG 1xE100 A MS

Part no. 10.01.30.00170

Flow Grippers for handling sensitive components

Number of ejectors: 1

Performance class: E100

with: Blow-off function

Mounting: Assembly laterally



SCG 1xE100 A MA SDA

Part no. 10.01.30.00359

Flow Grippers for handling sensitive components

Number of ejectors: 1

Performance class: E100

with: Blow-off function

Mounting: Assembly axially

with: Axial silencer



SCG 1xE100 A MS SDA

Part no. 10.01.30.00360

Flow Grippers for handling sensitive components

Number of ejectors: 1

Performance class: E100

with: Blow-off function

Mounting: Assembly laterally

with: Axial silencer