

Needle gripper

SNGi-AE 10 1.2 V 10 IOL

<https://www.schmalz.com/10.01.29.00396>



Part no.: 10.01.29.00396

Homepage > Vacuum Technology for Automation > Vacuum Components > Special Grippers > Needle Grippers > Electric Needle Grippers SNGi-AE > SNGi-AE 10 1.2 V 10 IOL

Electrical needle gripper in maintenance-friendly design and infinitely adjustable stroke



Number of needles: 10
 Needle diameter: 1.2 mm
 Needle stroke Z(NA): 10 mm
 Communication: IO-Link (Class B)

Design Data

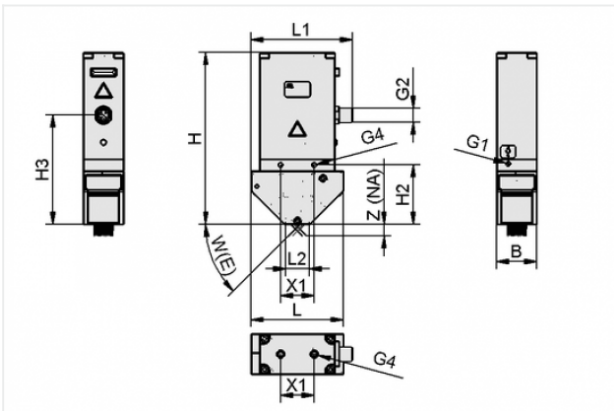

Attribute	Value
B	35 mm
G1	M5-F
G2	M12x1-M
G4	M5-F
H	151.5 mm
H2	51.5 mm
H3	94.5 mm
L	80 mm
L1	87.5 mm
L2	22 mm
W (E)	45 °
X1	29 mm

Contact to Schmalz

J. Schmalz GmbH | Johannes-Schmalz-Straße, 72293 Glatten, Deutschland | +49 7443 2403-102 | customercenter@schmalz.de

Attribute	Value
Z (NA)	10 mm

Technical Data

Attribute	Value
Number of needles	10
Needle diameter	1.2 mm
Ambient temperature	5 ... 50 °C
Weight	515 g
Protection	IP 53
Voltage	24V - DC
Current consumption	900 mA
Additional function	Variable stroke

Spare Parts



ERS-SET SNG-AP/AE 10 1.2 10

Part no. 10.01.29.00408

Set of spare parts

for: Needle gripper

Size: AP/AE

contains: 2 Needle wedges inst.

Number of needles: 10

Needle diameter: 1.2 mm

Needle stroke Z(NA): 10 mm



ERS-SET SNG-AP/AE 10

Part no. 10.01.29.00420

Set of spare parts
for: Needle gripper

Size: AP/AE

Needle stroke Z(NA): 10 mm

Accessories



BEF-PL 38x15x11.5 G1/4-IG SNG

Part no. 10.01.29.00403

Mounting plate

Length: 38 mm

Width: 15 mm

Height: 11.5 mm

Thread 1: G1/4-F

for: Needle gripper



HTS-A2 AP SNG

Part no. 10.01.29.00402

Holder system

Cross-beam connection:

Bolt with slot Ø19mm

Shape: with adapterplate

for: Needle gripper



HTS-A3 AP SNG AP/AE

Part no. 10.01.29.00322

Holder system

Cross-beam connection:

Ball head 28.5 mm

Shape: with adapterplate
for: Needle gripper

Size: AP/AE



ASK B-M12-5 5000

Part no. 21.04.05.00080

Connection cable

Interface Connection cable:

Fem connect M12, 5 pol

Cable length: 5000 mm

Material: PUR-Cable



ASK B-M12-5 1000 S-M12-5

Part no. 21.04.05.00158

Connection cable

Interface Connection cable:

Fem connect M12, 5 pol

Cable length: 1000 mm

Interface Connection cable:

Male connect M12, 5 pol

Material: PUR-Cable



ASK B-M12-5 2000 S-M12-5

Part no. 21.04.05.00211

Connection cable

Interface Connection cable:

Fem connect M12, 5 pol

Cable length: 2000 mm

Interface Connection cable:

Male connect M12, 5 pol

Material: PUR-Cable



ASV IO-L-A 2xS-M12-4

Part no. 10.02.02.04336

Connection distributor

for: IO-Link class A

Interface Connection cable:

Fem connect M12, 5 pol

Interface Connection cable:

2xConnect M12, 4 pol

Length L: 1000 mm