

Magnetic gripper

SGM-HD-S 70 G1/4-IG PNP

<https://www.schmalz.com/10.01.17.00354>



Part no.: 10.01.17.00354

Homepage > Vacuum Technology for Automation > Vacuum Components > Special Grippers > Magnetic Grippers > Magnetic Grippers SGM > SGM-HD-S 70 G1/4-IG PNP

Magnetic gripper for handling metal sheets with holes



Size: 70
 Socket: G1/4"-F
 Holding force max friction ring: 290 N
 Pressure range (operating pressure):
 3.5 ... 6.0 bar
 Additional function: Sensor PNP
 Interface Connection 1:
 Male connect M12, 4 pol

Design Data

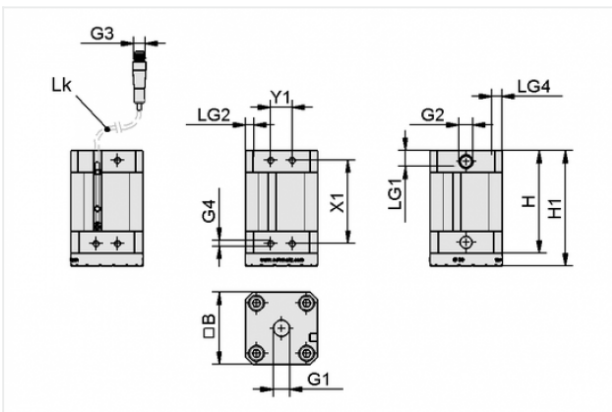

Attribute	Value
B	68 mm
G1	G1/4"-F
G2	G1/8"-F
G3	M12x1-M
G4	M5-F
H	80.2 mm
LG1	11 mm
LG2	6 mm
LG4	8 mm
Lk	300 mm
X1	58 mm
Y1	15 mm

Contact to Schmalz

J. Schmalz GmbH | Johannes-Schmalz-Straße, 72293 Glatten, Deutschland | +49 7443 2403-102 | customercenter@schmalz.de

Technical Data

Attribute	Value
Remaining force	0.3 N
Pressure range (operating pressure)	3.5 ... 6.0 bar
Installation position	Any
Control	Bistable
Ambient temperature	5 ... 70 °C
Weight	995.9 g

Note:

- Holding force: The value given is a statistical value with no safety factor; based on a plate with a thickness of 2 mm. For system configurations with magnetic grippers SGM, a safety factor of $S = 3$ must be applied

Spare Parts



NAEH-SCHA SMAGN-PNP S051

Part no. 10.01.17.00199

Proximity switch

Type: Magn. cylind. sensor-PNP

Voltage: 15-30V DC

Electrical connection:

Male connect M12, 4 pol



REIB-RING SGM 70 PU-55

Part no. 10.01.17.00139

Friction ring

for: Magnetic gripper

Size: 70

External diameter D: 68 mm

Internal diameter d: 51 mm

Accessories



ASK B-M12-5 5000

Part no. 21.04.05.00080

Connection cable

Interface Connection cable:

Fem connect M12, 5 pol

Cable length: 5000 mm

Material: PUR-Cable



HTS-A2 SGM 50/70

Part no. 10.01.17.00172

Holder system

Cross-beam connection:

Bolt with slot Ø19mm

for: Magnetic gripper

Size: 50/70



HTS-A3 SGM 50/70

Part no. 10.01.17.00173

Holder system

Cross-beam connection:

Ball head 28.5 mm

for: Magnetic gripper

Size: 50/70



HTS-A2 D SGM 50/70

Part no. 10.01.17.00178

Holder system

Cross-beam connection:

Bolt with slot \varnothing 19mm

Shape: Double block

for: Magnetic gripper

Size: 50/70



HTS-A3 D SGM 50/70

Part no. 10.01.17.00179

Holder system

Cross-beam connection:

Ball head 28.5 mm

Shape: Double block

for: Magnetic gripper

Size: 50/70

**VSL 6-4 PU**

Part no. 10.07.09.00002

Hose for vacuum and compressed-air systems

External diameter D: 6 mm

Internal diameter d: 4 mm

Length (max): 500 m

Material: PU

Installation radius (min): 35 mm

Pressure range (operating pressure):

-0.95 ... 10.00 bar

Ambient temperature: -20 ... 90 °C

**STV-GE G1/8-AG 6**

Part no. 10.08.02.00204

Screw plug connection, straight

Thread G1: G1/8-M

External hose diameter: 6 mm

Material: Brass

Surface: nickel plated

Ambient temperature: -20 ... 80 °C

**STV-W G1/8-AG 6**

Part no. 10.08.02.00158

Screw plug connection, swivelling elbow

Thread G1: G1/8-M

External hose diameter: 6 mm

Material: Brass, nickel-plated

Ambient temperature: -20 ... 80 °C