

Plug union, elbow STV-W G1/4-AG 6

<https://www.schmalz.com/10.08.02.00159>



Part no.: 10.08.02.00159

Homepage > Vacuum Technology for Automation > Vacuum Components > Filters and Connections > Hoses and Connectors > Screw in Push Fittings > STV-W G1/4-AG 6

Screw plug connection, swivelling elbow



Thread G1: G1/4-M
External hose diameter: 6 mm
Material: Brass, nickel-plated
Ambient temperature: -20 ... 80 °C

Design Data

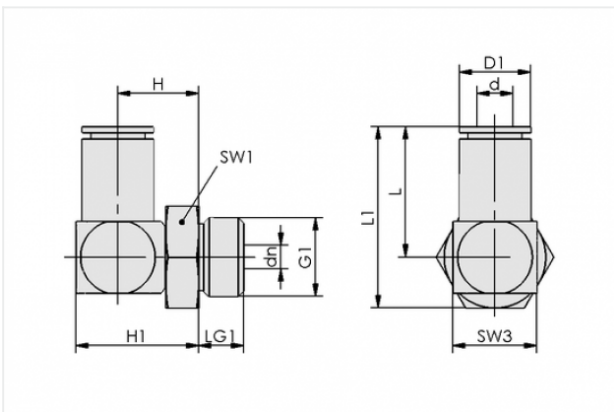

Attribute	Value
-----------	-------

d	6 mm
dn	4.1 mm
D1	11.3 mm
G1	G1/4"-M
H	13.5 mm
H1	20.4 mm
L	20.2 mm
L1	29.4 mm
LG1	7.5 mm
SW1	17 mm
SW3	14 mm

Contact to Schmalz

J. Schmalz GmbH | Johannes-Schmalz-Straße, 72293 Glatten, Deutschland | +49 7443 2403-102 | customercenter@schmalz.de

Technical Data

Attribute	Value
Hose type	6-4
Material	Brass, nickel-plated
Pressure range (operating pressure)	-0.95 ... 15.00 bar
Ambient temperature	-20 ... 80 °C
for	Hose D = 6 d = 4
Weight	37 g

Accessories



VSL 6-4 PTFE

Part no. 10.07.09.00157
 Hose for vacuum and compressed-air systems
 External diameter D: 6 mm
 Internal diameter d: 4 mm
 Length (max): 50 m
 Material: Polytetrafluorethylene
 Installation radius (min): 35 mm
 Colour: natur
 Ambient temperature: -190 ... 260 °C



VSL 6-4 PE

Part no. 10.07.09.00014
 Hose for vacuum and compressed-air systems
 External diameter D: 6 mm
 Internal diameter d: 4 mm
 Length (max): 100 m
 Material: PE
 Installation radius (min): 35 mm
 Pressure range (operating pressure):
 -0.95 ... 10.00 bar
 Ambient temperature: -30 ... 70 °C

Contact to Schmalz

**VSL 6-4 PU**

Part no. 10.07.09.00002

Hose for vacuum and compressed-air systems

External diameter D: 6 mm

Internal diameter d: 4 mm

Length (max): 500 m

Material: PU

Installation radius (min): 35 mm

Pressure range (operating pressure):

-0.95 ... 10.00 bar

Ambient temperature: -20 ... 90 °C