

Flat suction cup (oval)

SAOF 60x23 HT2-65 G3/8-IG

<https://www.schmalz.com/10.01.05.00741>



Part no.: 10.01.05.00741

Homepage > Vacuum Technology for Automation > Vacuum Components > Vacuum Suction Cups > Suction Cups for High-Temperature Applications > Flat Suction Cups SAOF HT2 (Oval) > SAOF 60x23 HT2-65 G3/8-IG

Flat suction cup (oval) for very dynamic handling



Dimensions (LxB): 60 x 23 mm
 Suction cup material:
 High temp material HT2
 Material hardness: 65 °Sh
 Temperature resistance: 250 °C
 Nipple material: Brass, nickel-plated
 Vacuum connection: G3/8-F

Design Data

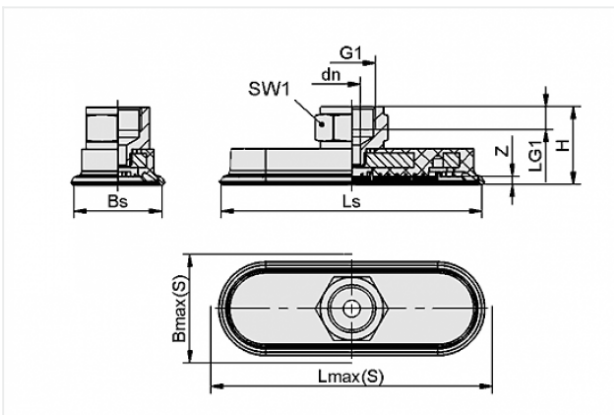

Attribute	Value
Bmax(S)	25 mm
Bs	21.6 mm
dn	6 mm
G1	G3/8"-F
H	26 mm
LG1	8 mm
Lmax(S)	64 mm
Ls	60.6 mm
SW1	22 mm
Z	3 mm

Contact to Schmalz

J. Schmalz GmbH | Johannes-Schmalz-Straße, 72293 Glatten, Deutschland | +49 7443 2403-102 | customercenter@schmalz.de

Technical Data

Attribute	Value
Suction force	57 N
Lateral force	36 N
Volume	3 cm ³
Curve radius (min) (convex)	20 mm
Internal hose diameter (recom.)	4 mm
Dimensions (LxB)	60 x 23 mm
Connection	G3/8"-F
Nipple material	Brass, nickel-plated
Number of folds	0
Suction cup material	High temp material HT2
Material hardness	65 °Sh
Temperature resistance	250 °C
Weight	44.7 g
Product family	SAOF
