

# Flat suction cup (oval)

## SAOF 120x60 NBR-60 G1/4-IG

<https://www.schmalz.com/10.01.05.00284>



Part no.: 10.01.05.00284

Homepage > Vacuum Technology for Automation > Vacuum Components > Vacuum Suction Cups > Flat Suction Cups (Oval) > Flat Suction Cups SAOF (Oval) > SAOF 120x60 NBR-60 G1/4-IG

## Flat suction cup (oval) for very dynamic handling of smooth and oily workpieces



Dimensions (LxB): 120 x 60 mm  
 Suction cup material:  
 Nitrile rubber NBR  
 Material hardness: 60 °Sh  
 Nipple material: Brass, nickel-plated  
 Vacuum connection: G1/4-F

### Design Data

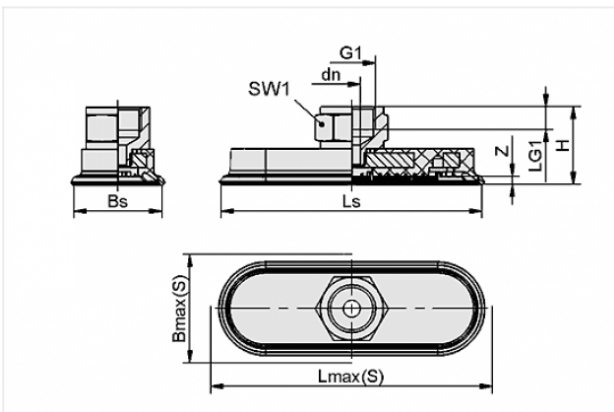

Attribute	Value
Bmax(S)	65 mm
Bs	57.6 mm
dn	8 mm
G1	G1/4"-F
H	32 mm
LG1	8 mm
Lmax(S)	128 mm
Ls	126.6 mm
SW1	17 mm
Z	6 mm

### Contact to Schmalz

J. Schmalz GmbH | Johannes-Schmalz-Straße, 72293 Glatten, Deutschland | +49 7443 2403-102 | [customercenter@schmalz.de](mailto:customercenter@schmalz.de)

## Technical Data

Attribute	Value
Suction force	312 N
Lateral force	254 N
Lateral force (oily surface)	170 N
Volume	39.9 cm <sup>3</sup>
Curve radius (min) (convex)	75 mm
Internal hose diameter (recom.)	6 mm
Dimensions (LxB)	120 x 60 mm
Number of folds	0
Suction cup material	Nitrile rubber NBR
Material hardness	60 °Sh
Weight	87 g
Product family	SAOF

### Note:

- Suction force: The specified suction forces are theoretical values at a vacuum of -0.6 bar and with a smooth, dry workpiece surface - they do not include a safety factor
- Lateral force: The specified lateral forces are values measured at a vacuum of -0.6 bar with a dry or oily, smooth, flat workpiece surface. Depending on the workpiece surface and its quality, the actual values may deviate from these values
- Hose diameter: The recommended hose diameter refers to a hose length of approx. 2 m