

Flat suction cup (oval)

<https://www.schmalz.com/10.01.05.00591>



SAOF 100x50 NBR-45
M14x1.5-AG

Part no.: 10.01.05.00591

Homepage > Vacuum Technology for Automation > Vacuum Components > Vacuum Suction Cups > Flat Suction Cups (Oval) > Flat Suction Cups
SAOF (Oval) > SAOF 100x50 NBR-45 M14x1.5-AG

Flat suction cup (oval) for very dynamic handling of smooth and oily workpieces



Dimensions (LxB): 100 x 50 mm

Suction cup material:

Nitrile rubber NBR

Material hardness: 45 °Sh

Nipple material: Aluminium

Vacuum connection: M14x1.5-M

Design Data

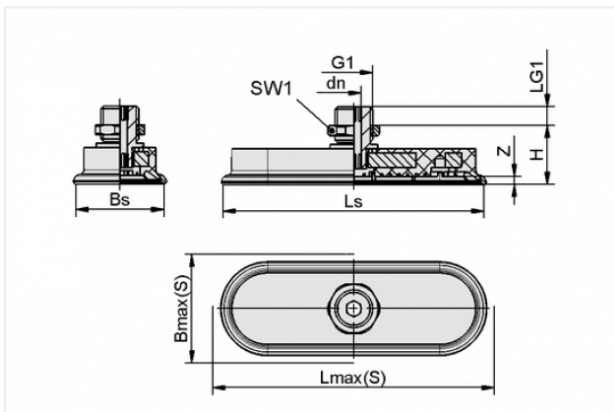

Attribute	Value
-----------	-------

Bmax(S)	54 mm
---------	-------

Bs	48.1 mm
----	---------

dn	6 mm
----	------

G1	M14x1.5-M
----	-----------

H	24 mm
---	-------

LG1	10 mm
-----	-------

Lmax(S)	106 mm
---------	--------

Ls	101.1 mm
----	----------

SW1	22 mm
-----	-------

Z	5 mm
---	------

Contact to Schmalz

J. Schmalz GmbH | Johannes-Schmalz-Straße, 72293 Glatten, Deutschland | +49 7443 2403-102 |
customercenter@schmalz.de

Technical Data

Attribute	Value
Suction force	217 N
Lateral force	181 N
Lateral force (oily surface)	121 N
Volume	21.8 cm ³
Curve radius (min) (convex)	75 mm
Internal hose diameter (recom.)	6 mm
Dimensions (LxB)	100 x 50 mm
Number of folds	0
Suction cup material	Nitrile rubber NBR
Material hardness	45 °Sh
Weight	76 g
Product family	SAOF

Note:

- Suction force: The specified suction forces are theoretical values at a vacuum of -0.6 bar and with a smooth, dry workpiece surface - they do not include a safety factor
- Lateral force: The specified lateral forces are values measured at a vacuum of -0.6 bar with a dry or oily, smooth, flat workpiece surface. Depending on the workpiece surface and its quality, the actual values may deviate from these values
- Hose diameter: The recommended hose diameter refers to a hose length of approx. 2 m